

# SX8654 Evaluation Kit

---

## User's Guide

---

## Table of Contents

<b>1</b>	<b>Introduction</b> .....	<b>4</b>
<b>2</b>	<b>Getting Started</b> .....	<b>5</b>
2.1	<i>Kit Contents</i> .....	5
2.2	<i>Installation</i> .....	5
2.2.1	Stand-Alone Demo.....	5
2.2.2	PC Software.....	5
<b>3</b>	<b>Hardware Description</b> .....	<b>6</b>
3.1	<i>Overview</i> .....	6
3.2	<i>Power Switch</i> .....	6
3.3	<i>USB Connector</i> .....	6
3.4	<i>Battery Connector</i> .....	7
3.5	<i>uC</i> .....	7
3.6	<i>Stand-alone Jumpers</i> .....	7
3.7	<i>TS Connectors</i> .....	7
3.8	<i>Motor</i> .....	7
3.9	<i>Push Buttons</i> .....	7
3.10	<i>Accelerometer</i> .....	7
3.11	<i>LEDs</i> .....	7
<b>4</b>	<b>Stand-Alone Demo</b> .....	<b>8</b>
<b>5</b>	<b>Graphical User Interface (GUI)</b> .....	<b>9</b>
5.1	<i>Overview</i> .....	9
5.2	<i>Drawing Pad</i> .....	10
5.3	<i>Call Demo</i> .....	11
5.3.1	<i>Angle Threshold</i> .....	12
5.3.2	<i>External Sensor</i> .....	12
5.3.3	<i>Software</i> .....	12
5.4	<i>Data Graph</i> .....	13
5.5	<i>Touch Settings</i> .....	14
5.6	<i>Proximity Settings</i> .....	15
5.7	<i>Haptic Settings</i> .....	16
<b>6</b>	<b>Schematics</b> .....	<b>17</b>
<b>7</b>	<b>Layout</b> .....	<b>18</b>
<b>8</b>	<b>References</b> .....	<b>19</b>

## Table of Figures

Figure 1: SX8654 Typical Application .....	4
Figure 2: SX8654EVK Contents .....	5
Figure 3: SX8654EVK Board Picture – Top (left) and Bottom (right).....	6
Figure 4: SX8654EVK Board Concept – Top (left) and Bottom (right).....	6
Figure 5: SX8654EVK LEDs Proximity Reporting – Far (left) vs Close (right) .....	8
Figure 6: SX8654EVK LEDs Touch Reporting – Touch (left) vs Move (right).....	8
Figure 7: SX8654EVK GUI Overview.....	9
Figure 8: SX8654EVK GUI Touch Reporting.....	10
Figure 9: SX8654EVK GUI Proximity Reporting – Far (left) vs Close (right).....	10
Figure 10: SX8654EVK GUI - Call Demo.....	11
Figure 11: SX8654EVK Face Detection Reporting – Board (left) and GUI (right).....	12
Figure 12: SX8654EVK GUI - Data Graphs .....	13
Figure 13: SX8654EVK GUI - Touch Settings.....	14
Figure 14: SX8654EVK GUI - Proximity Settings (Analog) .....	15
Figure 15: SX8654EVK GUI - Proximity Settings (Digital) .....	15
Figure 16: SX8654EVK GUI - Haptic Settings.....	16

## 1 Introduction

The purpose of this tool is to provide an evaluation platform for the SX8654/55/56/57/58, a family of haptics enabled 4/5-wire resistive touchscreen controllers with proximity sensing. Typical applications are mobile phones, game machines, portable music players, POS/POI terminals, etc.

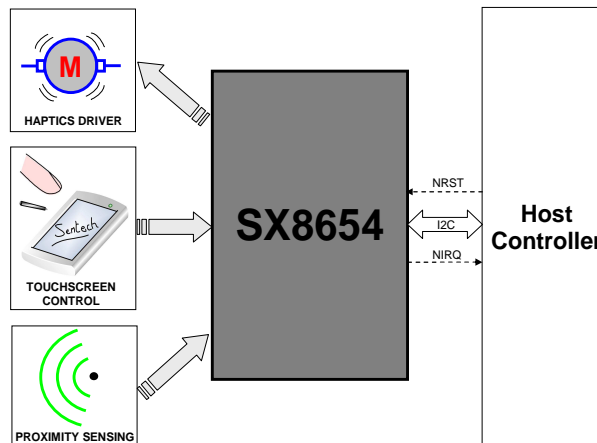

Figure 1: SX8654 Typical Application

SX8654 main features include:

- Low Voltage Operation
  - 2.3V to 3.6V Supply
  - Integrated Low Drop Out (LDO) Regulator
- Low Power Consumption
  - 30uA@2.3V 8ksps (ESR)
  - 0.4uA Shut-Down Current
- 4/5-Wire Touchscreen Interface
  - Precision, Ratiometric 12-bit ADC
  - Up to 5000 (X-Y) coordinates/second (c/s)
  - Programmable Digital Filtering/Averaging
  - Touch Pressure Measurement (4-Wire)
- Integrated Capacitive Proximity Sensing
  - No Additional Components Required
  - Uses Resistive Touchscreen or a Simple Conductive Area as the Sensor
  - >5 cm Detection Distance
  - 8uA @ 200ms Scan Period
- Haptics Driver for LRA and ERM Micro Motors
  - Haptics Waveform Generation Control (I2C or PWM Input)
  - Short Circuit Protection
  - Early Warning and Over-Temperature Monitoring and Protection
- 400kHz I2C Serial Interface
- Hardware, Software, and Power-On Reset
- 15kV HBM & IEC ESD Protection

## 2 Getting Started

### 2.1 Kit Contents

As illustrated in the figure below, the SX8654 Evaluation kit is composed of:

- SX8654EVK board
- SX8654EVK CDROM including all necessary PC software and documentation (requires min Windows XP)
- Mini USB cable to connect the SX8654EVK board to the PC



Figure 2: SX8654EVK Contents

### 2.2 Installation

#### 2.2.1 Stand-Alone Demo

- 1- Connect the SX8654EVK board to a USB port/supply via the cable provided.
- 2- Wait for a few seconds.
- 3- SX8654EVK is now ready to be used! (see §4 for more details).

#### 2.2.2 PC Software

- 1- Put the CDROM in your computer. If the installation does not start automatically, launch "SX8654\_74EvaluationKitSetup.exe" manually.
- 2- Follow installation guidelines until the process is completed. Please note that .NET Framework 3.5 will be automatically downloaded and installed if not detected on your computer.
- 3- Connect the SX8654EVK board to the PC via the mini USB cable.
- 4- Launch "Semtech->SX8654\_74Evaluation->SX8654\_74Evaluation" from Start menu.
- 5- SX8654EVK is now ready to be used! (see §5 for more details).

### 3 Hardware Description

SX8654EVK board is described in this chapter. Please refer to the schematics and layout provided at the end of the document for more details about the exact hardware implementation.

#### 3.1 Overview

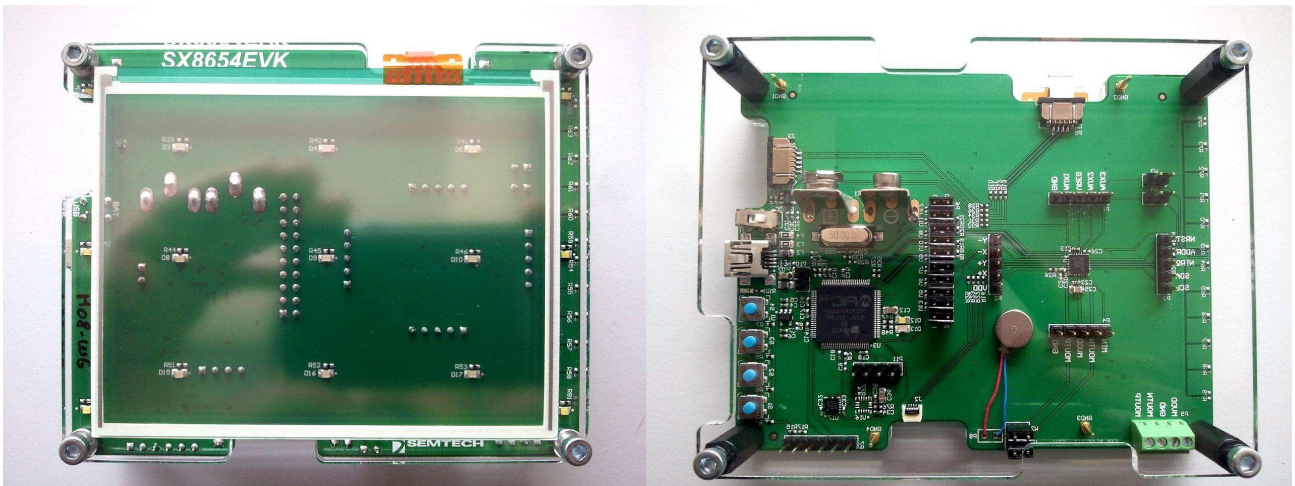

Figure 3: SX8654EVK Board Picture – Top (left) and Bottom (right)

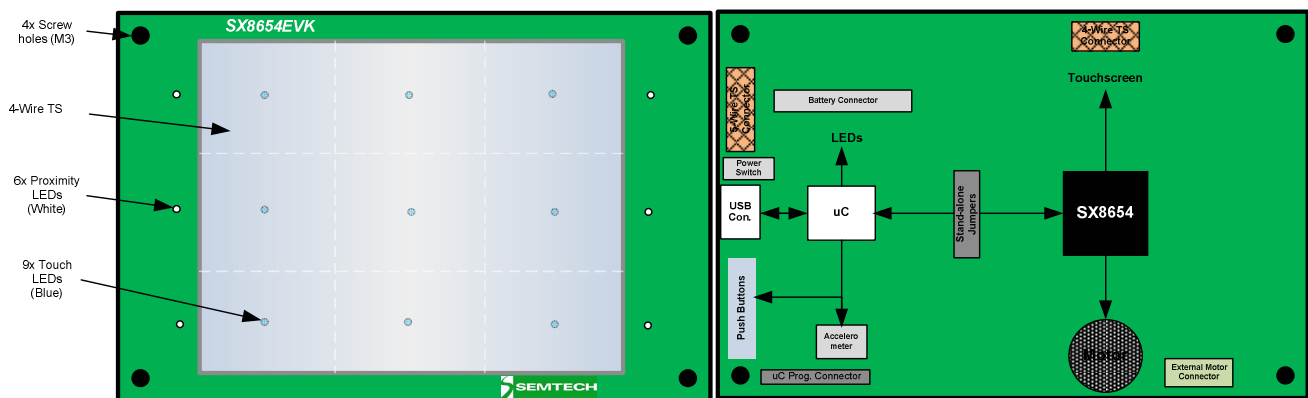

Figure 4: SX8654EVK Board Concept – Top (left) and Bottom (right)

#### 3.2 Power Switch

The power switch allows the user to select the power source (USB or Battery) and also at the same time turn ON/OFF the EVK. It is associated to a red LED to indicate power-on.

#### 3.3 USB Connector

The USB connector allows the EVK to be connected to a PC from which it will get its power and configuration/control commands via the dedicated GUI.

### **3.4 Battery Connector**

The battery connector allows the EVK to be supplied from a standard 9V battery and hence allow a full freedom of movement. In this configuration only the stand alone demo is available (no USB i.e. no GUI).

### **3.5 uC**

The uC (PIC32MX460F512L) implements the low level drivers for the SX8654 (FW) and interfaces to the PC software (GUI). It also controls the on-board LEDs, push buttons and accelerometer.

### **3.6 Stand-alone Jumpers**

These jumpers are placed on all the signals connecting the uC to the SX8654 (SDA, SCL, NRESET, NINT, AUX1-3, MIN, VDD, MVDD). Their purpose is, as their name suggests, being able to disconnect the SX8654 side from the rest of the EVK to access it externally (with an external uC, sharing another I2C bus, etc.)

### **3.7 TS Connectors**

Connectors for both 4-wire and 5-wire touchscreens are available (Cf. schematics for references). The EVK is populated with a 4-wire touchscreen (Fujitsu N010-0554-T703) which is used to extract the touch coordinate and sense proximity.

### **3.8 Motor**

The motor provides tactile feedback to the user when the screen is touched. The EVK is populated with an ERM (Precision Microdrives 308-100) but a generic connector is available to be able to attach any other motor instead.

### **3.9 Push Buttons**

The push buttons on bottom side are used for several purposes like stand alone demo configuration (S2, Cf. §4) or firmware update (S4).

### **3.10 Accelerometer**

An accelerometer (Bosch BMA150) has been added to monitor board orientation (Cf. Call Demo §5.3).

### **3.11 LEDs**

On the top side of the EVK, one can find two types of LEDs:

- 9x Blue LEDs : these are located below the TS and typically indicate the area of the touchscreen which is being touched
- 6x White LEDs : these are located on the sides of the TS and typically indicate the proximity status.

## 4 Stand-Alone Demo

The purpose of the stand-alone demo is to be able to easily/quickly demonstrate SX8654 functionality (touch, proximity, haptics) without having to install or launch the GUI. It starts automatically as soon as the board is powered (thru USB or battery).

As described in figure below, proximity sensing status is reported via the white LEDs located on the edge of the touchscreen.

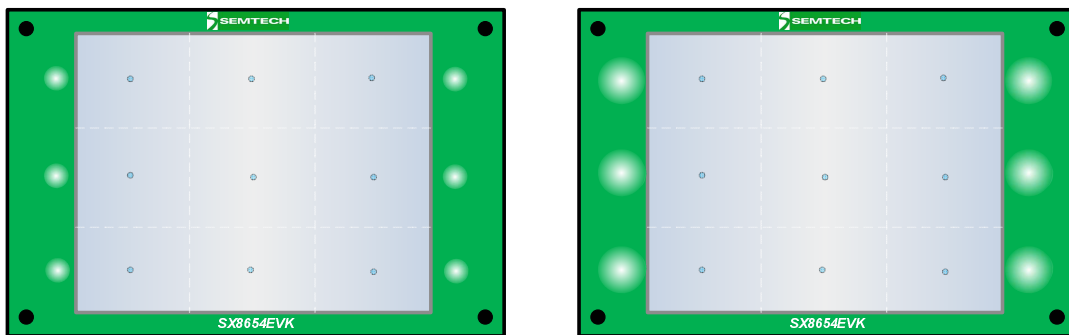

Figure 5: SX8654EVK LEDs Proximity Reporting – Far (left) vs Close (right)

As described in figure below, touch coordinates are reported via the blue LEDs located below the touchscreen. When the screen is touched a short haptics vibration will be generated together with turning on the LED corresponding to the touched area. When the user moves his finger on the screen the blue LEDs follow but no vibration is generated.

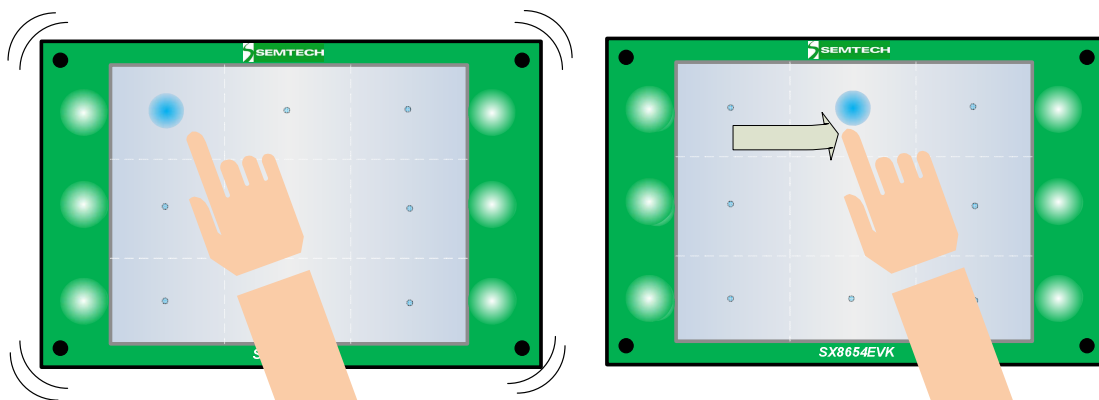

Figure 6: SX8654EVK LEDs Touch Reporting – Touch (left) vs Move (right)



## 5 Graphical User Interface (GUI)

### 5.1 Overview



Figure 7: SX8654EVK GUI Overview

## 5.2 Drawing Pad

The drawing pad allows the user to visualize both the touch and proximity status.

As illustrated in figure below, touch coordinates are displayed as black dots/lines. The screen can be cleared anytime by pressing button "Clear" in the top-left corner.



Figure 8: SX8654EVK GUI Touch Reporting

As illustrated in figure below, proximity status is reported by changing background color (similarly to the on-board white LEDs). Proximity reporting can be disabled anytime by pressing right-click and unticking "Detect Proximity".

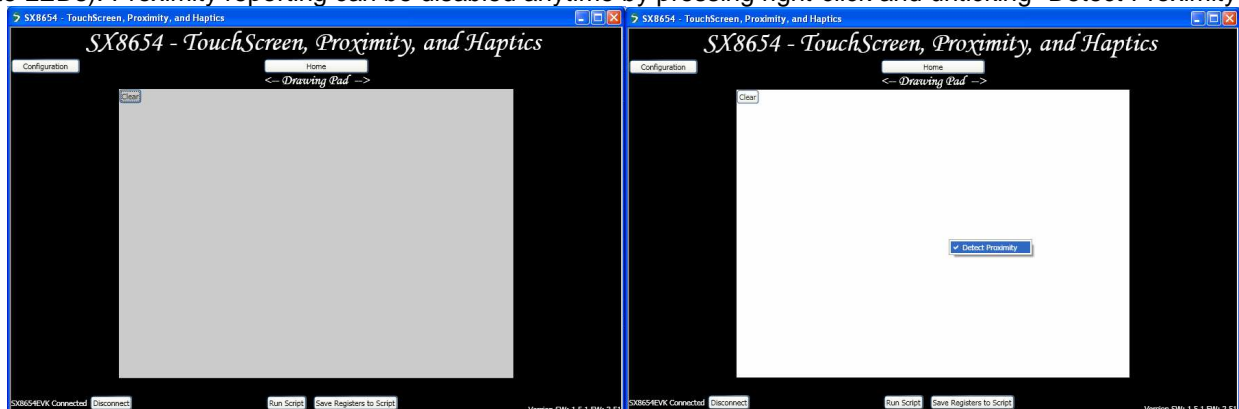

Figure 9: SX8654EVK GUI Proximity Reporting – Far (left) vs Close (right)

### 5.3 Call Demo

In today's cellphones, infrared-based proximity sensing is used to detect when (during a call) the phone is close to the face and consequently turn the screen OFF. Finger proximity should not be detected or reported separately.

The purpose of the call demo is to demonstrate how the SX8654 and its capacitive proximity sensing technology can be used to perform similar function at a fraction of current IR solutions' cost.

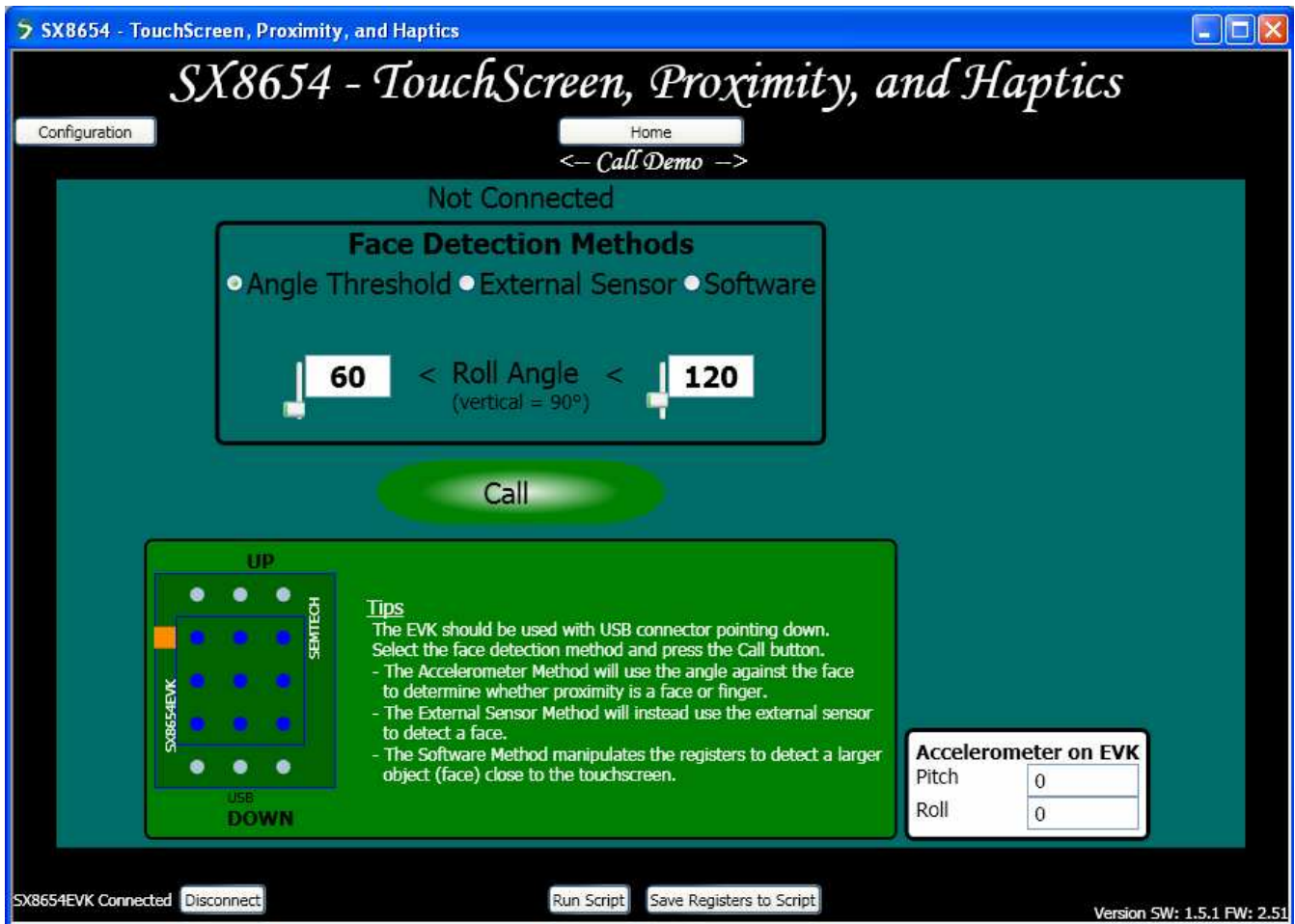

Figure 10: SX8654EVK GUI - Call Demo

The call demo of the SX8654EVK implements 3 face detection methods described in details in the following paragraphs:

- Angle Threshold
- External Sensor
- Software

Each of these methods alone or combined together can be used in a final system to perform optimum face (vs finger) detection.

When face is detected the white LEDs on the board will completely turn OFF and the GUI will turn black (similarly to what the LCD backlight of a cellphone would do).

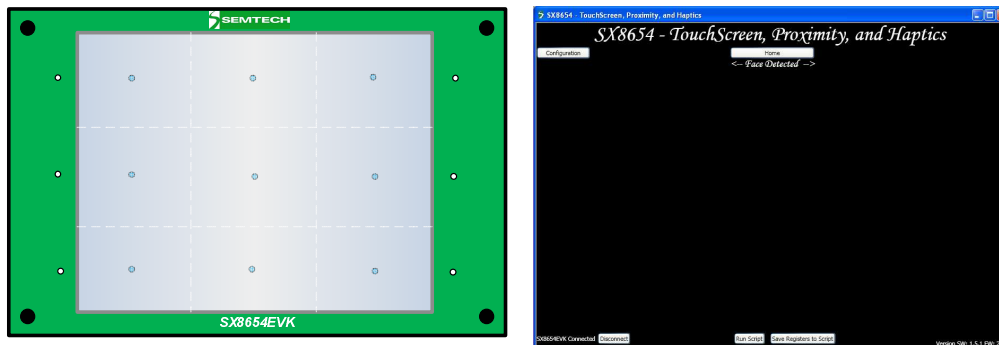

Figure 11: SX8654EVK Face Detection Reporting – Board (left) and GUI (right)

Note that the Call Demo can also be launched without GUI. Pressing S2 will allow selecting the face detection method to be used (1 press => Angle Threshold; 2 presses => External Sensor; 3 presses => Software)

### 5.3.1 Angle Threshold

This method exploits the fact that in normal operation the phone is quasi-vertical (i.e. user is sitting, standing, walking, etc) when a call is being picked up while it is not when finger is used to touch the screen (screen quasi-horizontal pointing-up towards user's face)

Based on this, the orientation of the board provided by the accelerometer is used to discriminate finger vs face:

- proximity detected + board quasi-vertical => Face
- proximity detected + board **not** quasi vertical => Finger

By default the angle is set to +/-30° around vertical position but can be changed freely on the GUI.

Most smartphones today already integrate an accelerometer; and because we use the existing standard touchscreen as the sensor this solution is very cost effective (no additional component or PCB area required).

### 5.3.2 External Sensor

This method does not use the touchscreen as the sensor but a small copper area on PCB located on the top of the screen ("speaker" area) similarly to current infrared-based solutions.

Having the sensor localized on top of the screen makes face detection straight forward:

- proximity detected => Face

Finger will never be hovering above the sensor area and hence will never be detected.

Note that because the area available for an external sensor is usually much smaller than the touchscreen area; the detection distance achievable will be lower (typ. 1cm **from sensor** in our case vs >5cm for touchscreen).

### 5.3.3 Software

This method uses the touchscreen as the sensor and exploits the fact that at the same distance from the screen the face will create a much bigger capacitance than the finger. By programming specific registers settings accordingly inside the chip (i.e. no host processing needed) it is possible to detect only the face and not the finger.

Software method requires the face to be within typ. 1cm from the screen for more than 1s before it is detected but comes at no extra cost (no additional component or PCB area needed).

### 5.4 Data Graph

As illustrated in figure below, data graphs allow observing in real time the evolution of the touch and proximity sensing data.

Please refer to SX8654 datasheet [1] for details about each parameter.

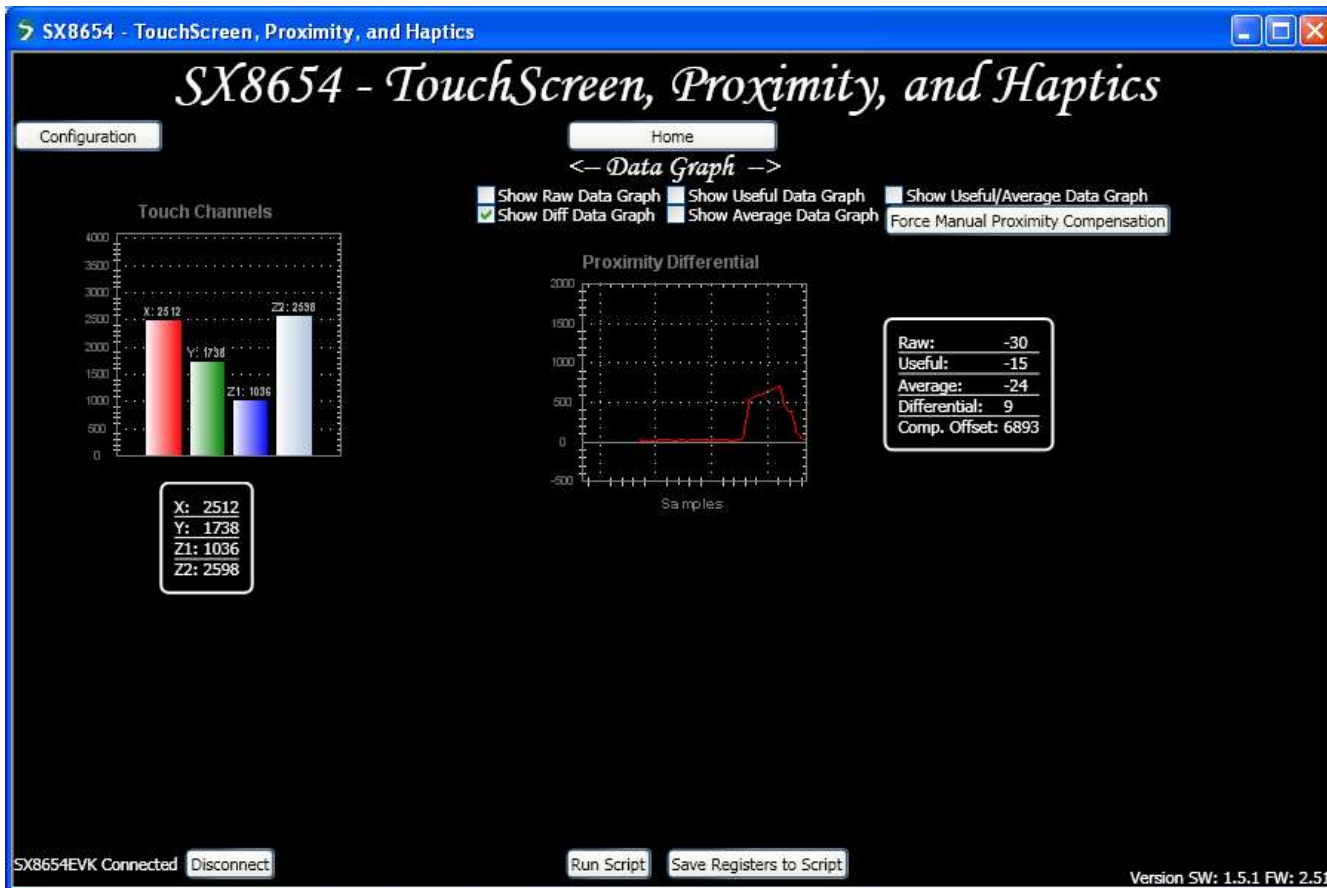

Figure 12: SX8654EVK GUI - Data Graphs

### 5.5 Touch Settings

This item allows advanced users to visualize and modify the touch parameters.

Please refer to SX8654 datasheet [1] for details about each parameter.

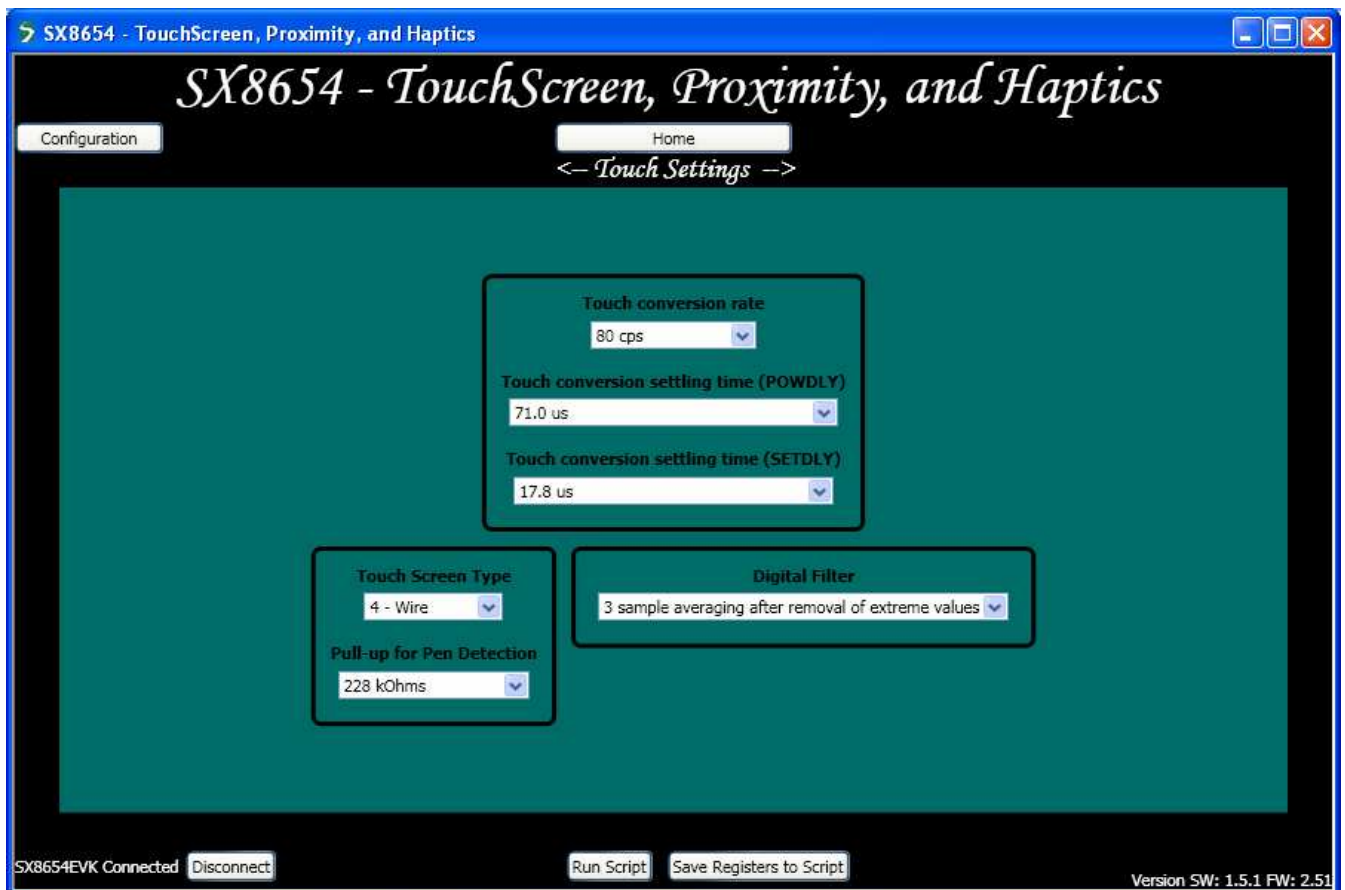

Figure 13: SX8654EVK GUI - Touch Settings

### 5.6 Proximity Settings

This item allows advanced users to visualize and modify the proximity parameters. It is divided into analog and digital sections.

Please refer to SX8654 datasheet [1] for details about each parameter.

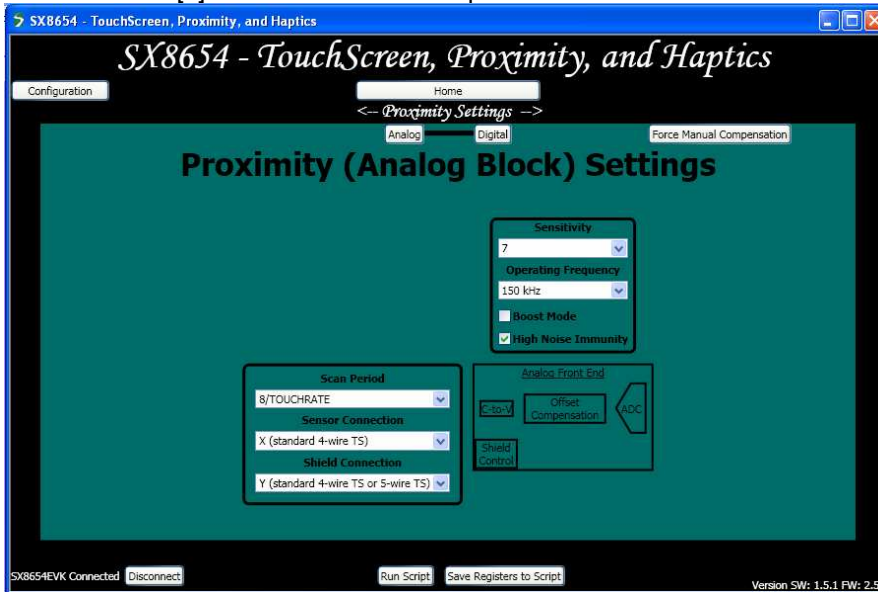

Figure 14: SX8654EVK GUI - Proximity Settings (Analog)

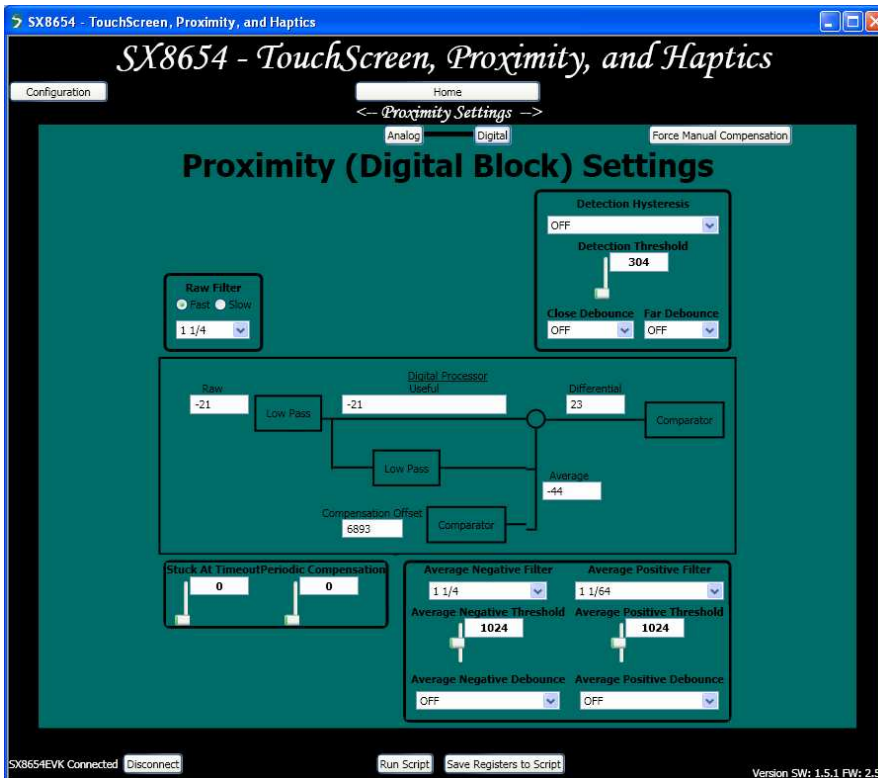

Figure 15: SX8654EVK GUI - Proximity Settings (Digital)



### 5.7 Haptic Settings

This item allows advanced users to visualize and modify the haptics parameters

Please refer to SX8654 datasheet [1] for details about each parameter.

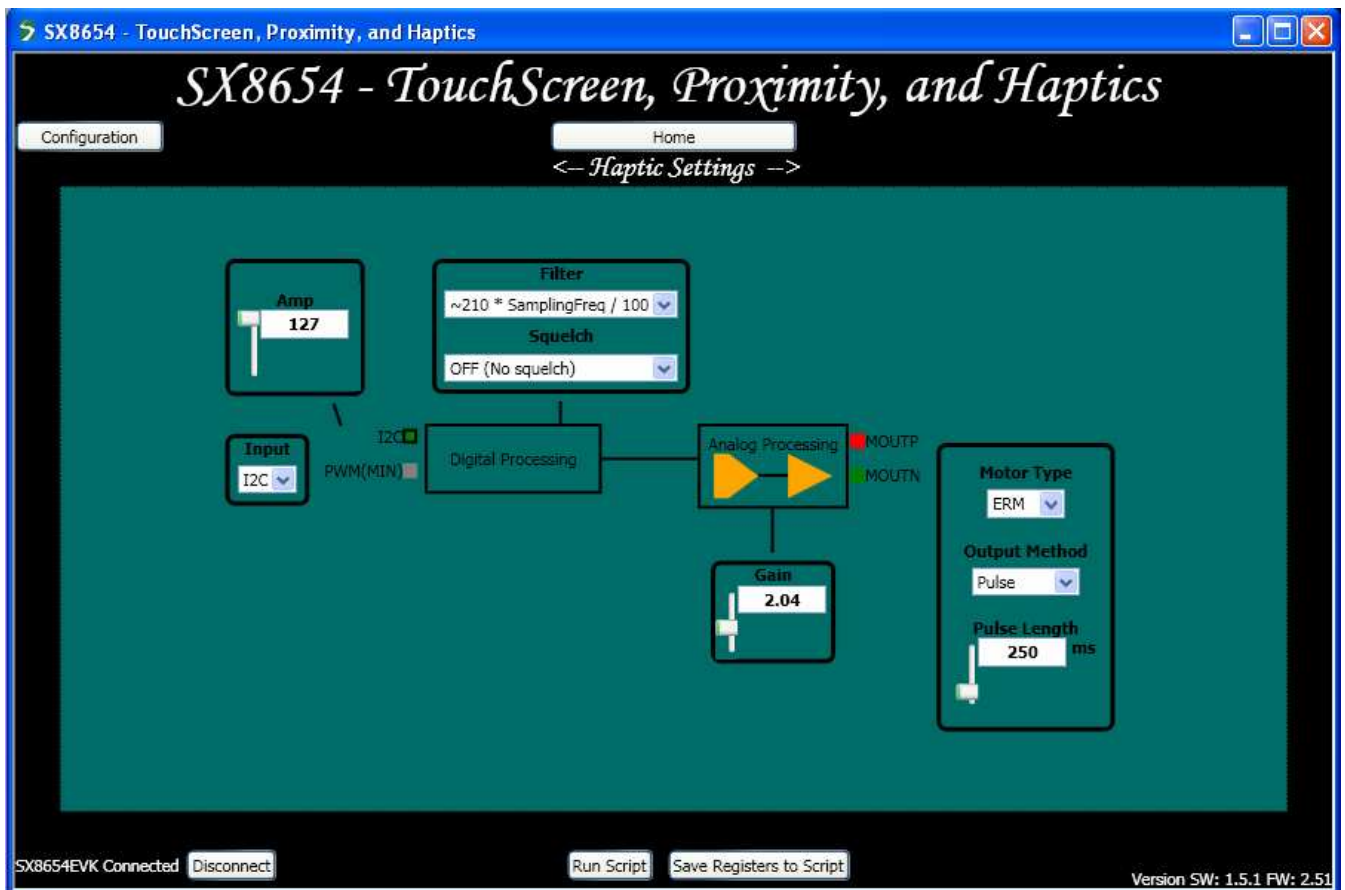
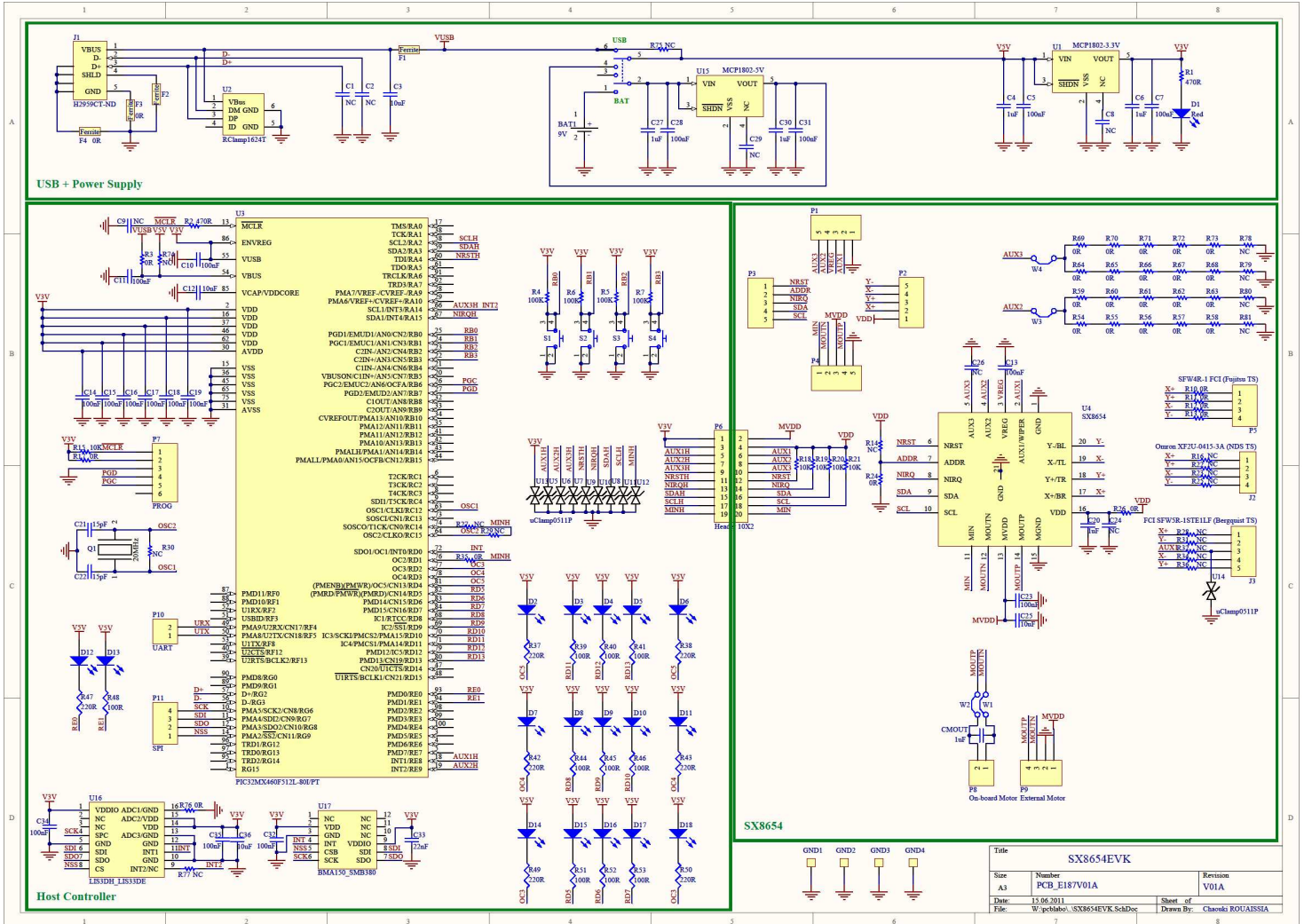

Figure 16: SX8654EVK GUI - Haptic Settings

Note that “Output Method” and “Pulse Length” are not chip parameters but just GUI parameters.



## 6 Schematics



## 7 Layout

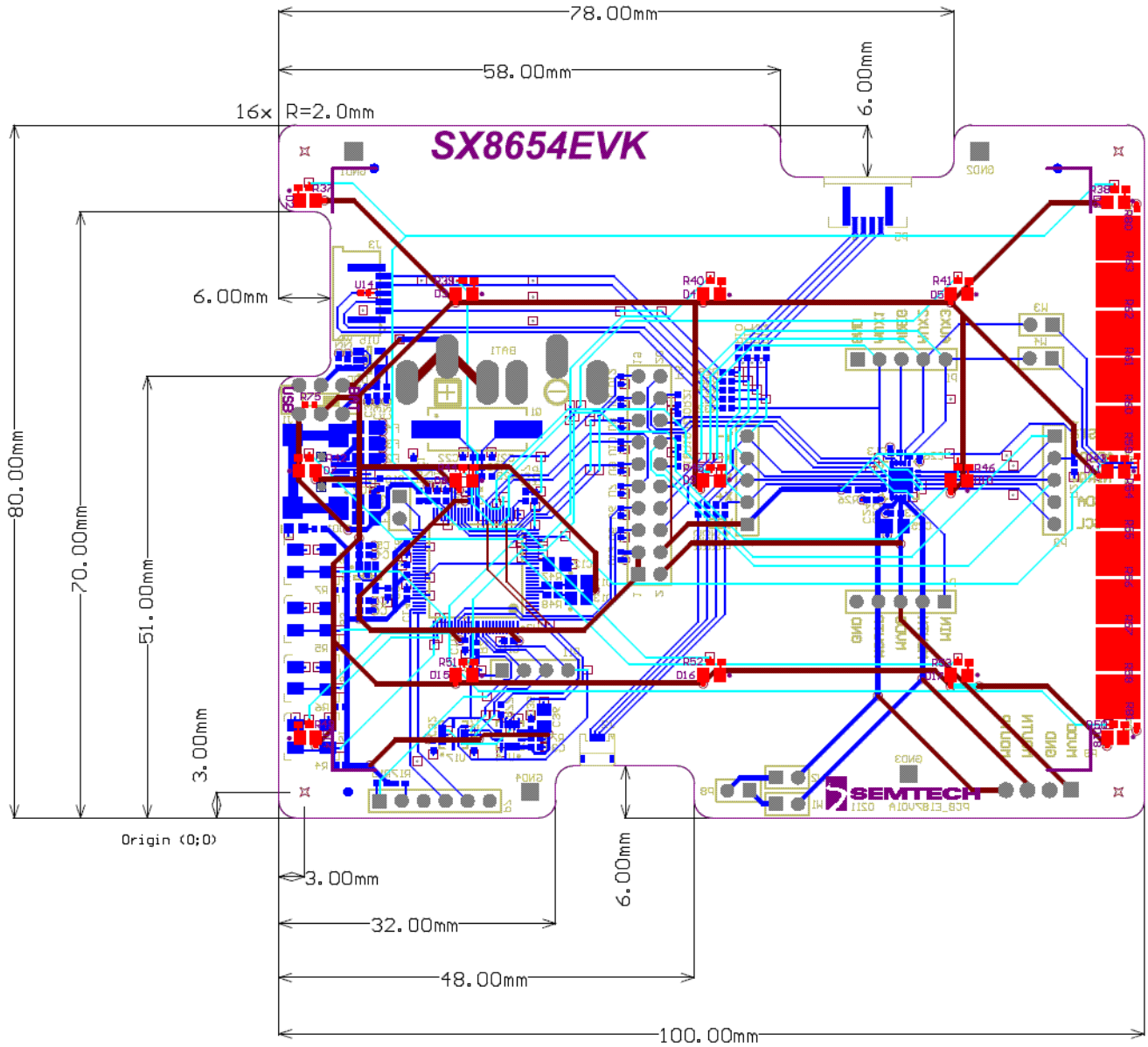

Ground planes removed for clarity.

## 8 References

- [1] SX8654/55/56 Datasheet

© Semtech 2011

All rights reserved. Reproduction in whole or in part is prohibited without the prior written consent of the copyright owner. The information presented in this document does not form part of any quotation or contract, is believed to be accurate and reliable and may be changed without notice. No liability will be accepted by the publisher for any consequence of its use. Publication thereof does not convey nor imply any license under patent or other industrial or intellectual property rights. Semtech assumes no responsibility or liability whatsoever for any failure or unexpected operation resulting from misuse, neglect improper installation, repair or improper handling or unusual physical or electrical stress including, but not limited to, exposure to parameters beyond the specified maximum ratings or operation outside the specified range.

SEMTECH PRODUCTS ARE NOT DESIGNED, INTENDED, AUTHORIZED OR WARRANTED TO BE SUITABLE FOR USE IN LIFE-SUPPORT APPLICATIONS, DEVICES OR SYSTEMS OR OTHER CRITICAL APPLICATIONS. INCLUSION OF SEMTECH PRODUCTS IN SUCH APPLICATIONS IS UNDERSTOOD TO BE UNDERTAKEN SOLELY AT THE CUSTOMER'S OWN RISK. Should a customer purchase or use Semtech products for any such unauthorized application, the customer shall indemnify and hold Semtech and its officers, employees, subsidiaries, affiliates, and distributors harmless against all claims, costs damages and attorney fees which could arise.

#### Contact Information

Semtech Corporation  
Advanced Communications and Sensing Products Division  
200 Flynn Road, Camarillo, CA 93012  
Phone: (805) 498-2111 Fax: (805) 498-3804