

1

2

3

4

5

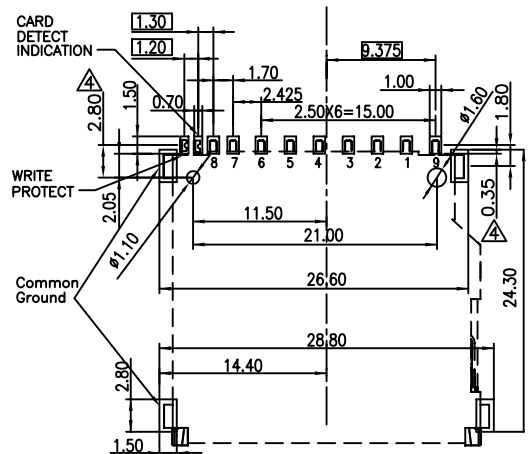

RECOMMENDED P.C.B LAYOUT  
TOLFRANCES: ±0.05mm

TECHNICAL CHARACTERISTICS

MATERIAL  
INSULATOR: LCP  
FLAMABILITY RATING: UL94-V0  
COLOR: BLACK  
CONTACT MATERIAL: COPPER ALLOY  
CONTACT TYPE: STAMPED  
CONTACT PLATING: SELECTIVE GOLD  
SHIELDING: COPPER ALLOY  
SHIELDING PLATING: NICKEL  
QUALITY CLASS: 10000 MATING CYCLES

ENVIRONMENTAL  
OPERATING TEMPERATURE: -25 UP TO 85°C  
COMPLIANCE: LEAD FREE AND ROHS

ELECTRICAL  
CURRENT RATING: 0.5A  
WORKING VOLTAGE: 100VAC  
INSULATOR RESISTANCE: >1000 MOHM  
DIELECTRIC WITHSTANDING VOLTAGE: 500VAC/MN  
CONTACT RESISTANCE: 100 mOHM MAX

SOLDERING  
REFLOW PROCESS ONLY

PACKAGING  
TAPE & REEL

PIN No	NAME	DESCRIPTION
1	CD/DAT3	CARD DETECTION
2	CMD	COMMAND/ANSWER
3	Vss1	GND
4	Vdd	POWER SUPPLY
5	CLK	CLOCK
6	Vss2	GND
7	DAT0	Connector data line 0
8	DAT1	Connector data line 1
9	DAT2	Connector data line 2

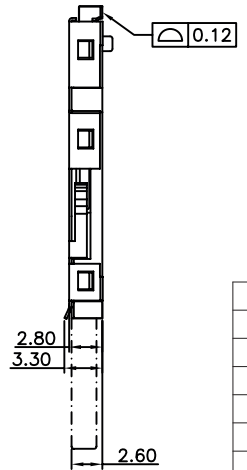
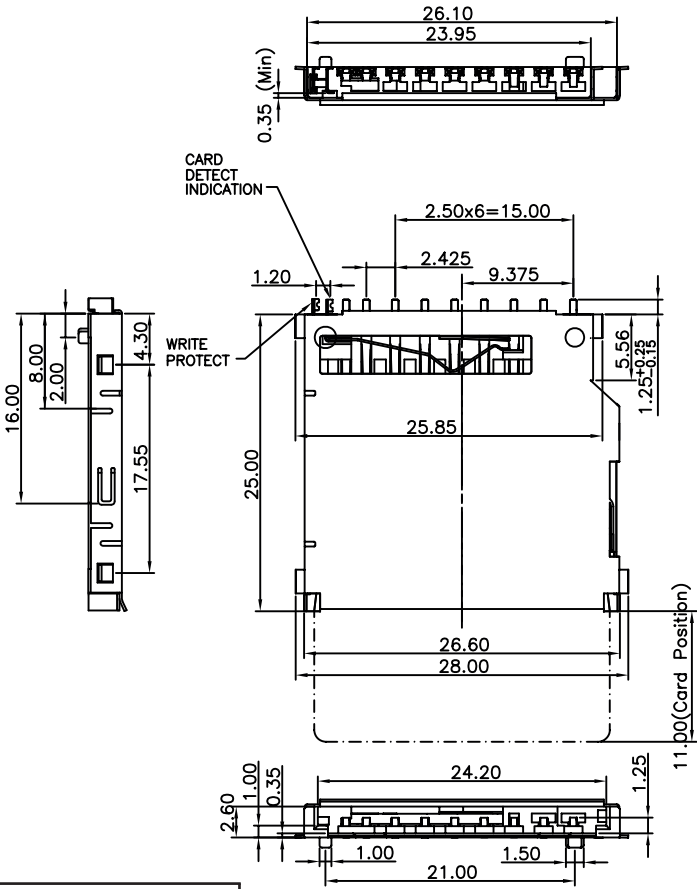
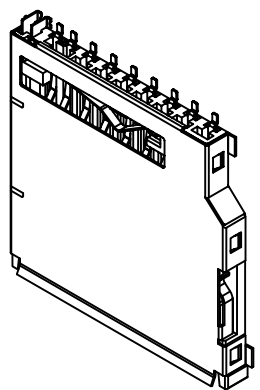

RoHS Compliant			
H	24-FEB-14	CARD DIM ADD	QL
REV	DATE	FILE	BY

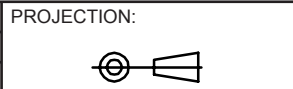

GENERAL TOLERANCE  
.X = +/- 0.2  
.XX = +/- 0.15



APPROVAL: RJ

UNIT: MM  
SCALE:  
SHEET: 1/3  
DRAW: VICKY

DESCRIPTION: SD Card Connector - Push & Pull - With Card Detection  
9 pins  
WERI PART NO: 693 063 010 911

SIZE  
**A4**

A

B

C

D

1

2

3

4

5

A

Contact OFF

Contact ON / Lock OFF

Contact ON / Lock ON

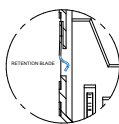

DETAIL L

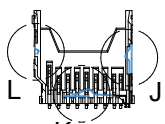

DETAIL K



DETAIL J

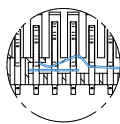

DETAIL K

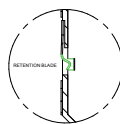

DETAIL N

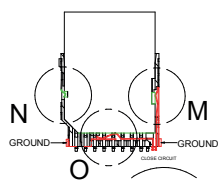

DETAIL O

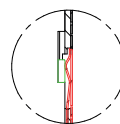

DETAIL M

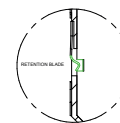

DETAIL Q

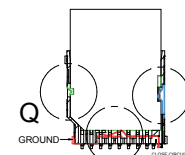

DETAIL R

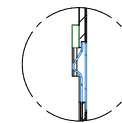

DETAIL P

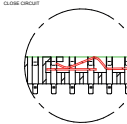

DETAIL R

B

C

Card detection switch		Write protection switch		
Card removed	Card inserted	Card removed	Card inserted	
			Write Protect	Write enable
OPEN	CLOSE	OPEN	OPEN	CLOSE

RoHS Compliant

PROJECTION:

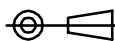

GENERAL TOLERANCE

.X = +/- 0.2

.XX = +/- 0.15



APPROVAL: RJ

UNIT: MM

SCALE:

SHEET: 2/3

DRAW: VICKY

DESCRIPTION: SD Card Connector - Push & Pull - With Card Detection  
9 pins

WERI PART NO: 693 063 010 911

SIZE

**A4**

D

REV      DATE

FILE

BY

1

2

3

4

5

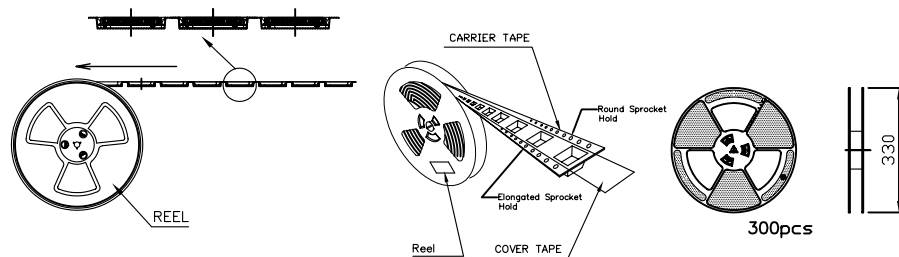
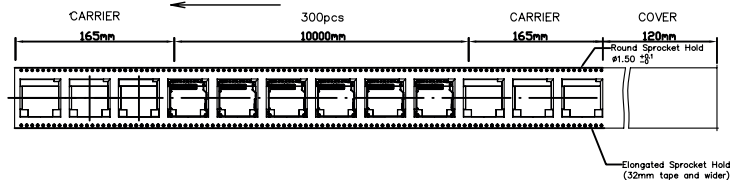
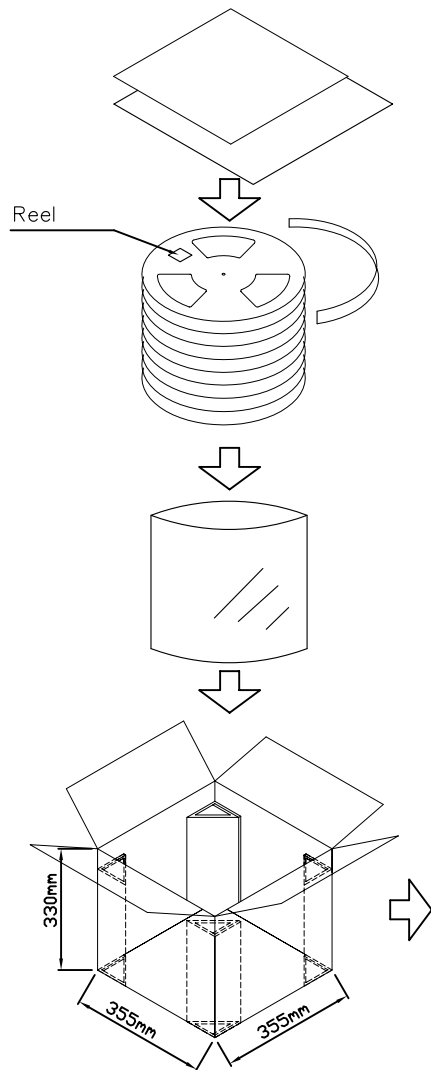

## NOTES

1. MATERIALS: PS
  2. PACKING: TAPE REEL(300PCS/R,1800PCS/CTN)
  3. SONY SS-00259 or RoHS
- All Material in According With The Rohs Environment Related Substances List Controlled.

RoHS Compliant

PROJECTION:

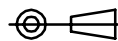

GENERAL TOLERANCE

.X =  $\pm 0.2$ .XX =  $\pm 0.15$ 

APPROVAL: RJ

UNIT: MM

SCALE:

SHEET: 3/3

DRAW: VICKY

**DESCRIPTION: SD Card Connector - Push & Pull - With Card Detection**  
9 pins

**WERI PART NO: 693 063 010 911**

SIZE

**A4**

REV

DATE

FILE

BY