



CY8CKIT-042

# PSoC<sup>®</sup> 4 Pioneer Kit Guide

Doc. # 001-86371 Rev. \*G

Cypress Semiconductor  
198 Champion Court  
San Jose, CA 95134-1709  
Phone (USA): 800.858.1810  
Phone (Intl): +1.408.943.2600  
<http://www.cypress.com>

## Copyrights

© Cypress Semiconductor Corporation, 2013-2016. This document is the property of Cypress Semiconductor Corporation and its subsidiaries, including Spansion LLC ("Cypress"). This document, including any software or firmware included or referenced in this document ("Software"), is owned by Cypress under the intellectual property laws and treaties of the United States and other countries worldwide. Cypress reserves all rights under such laws and treaties and does not, except as specifically stated in this paragraph, grant any license under its patents, copyrights, trademarks, or other intellectual property rights. If the Software is not accompanied by a license agreement and you do not otherwise have a written agreement with Cypress governing the use of the Software, then Cypress hereby grants you a personal, non-exclusive, nontransferable license (without the right to sublicense) (1) under its copyright rights in the Software (a) for Software provided in source code form, to modify and reproduce the Software solely for use with Cypress hardware products, only internally within your organization, and (b) to distribute the Software in binary code form externally to end users (either directly or indirectly through resellers and distributors), solely for use on Cypress hardware product units, and (2) under those claims of Cypress's patents that are infringed by the Software (as provided by Cypress, unmodified) to make, use, distribute, and import the Software solely for use with Cypress hardware products. Any other use, reproduction, modification, translation, or compilation of the Software is prohibited.

TO THE EXTENT PERMITTED BY APPLICABLE LAW, CYPRESS MAKES NO WARRANTY OF ANY KIND, EXPRESS OR IMPLIED, WITH REGARD TO THIS DOCUMENT OR ANY SOFTWARE OR ACCOMPANYING HARDWARE, INCLUDING, BUT NOT LIMITED TO, THE IMPLIED WARRANTIES OF MERCHANTABILITY AND FITNESS FOR A PARTICULAR PURPOSE. To the extent permitted by applicable law, Cypress reserves the right to make changes to this document without further notice. Cypress does not assume any liability arising out of the application or use of any product or circuit described in this document. Any information provided in this document, including any sample design information or programming code, is provided only for reference purposes. It is the responsibility of the user of this document to properly design, program, and test the functionality and safety of any application made of this information and any resulting product. Cypress products are not designed, intended, or authorized for use as critical components in systems designed or intended for the operation of weapons, weapons systems, nuclear installations, life-support devices or systems, other medical devices or systems (including resuscitation equipment and surgical implants), pollution control or hazardous substances management, or other uses where the failure of the device or system could cause personal injury, death, or property damage ("Unintended Uses"). A critical component is any component of a device or system whose failure to perform can be reasonably expected to cause the failure of the device or system, or to affect its safety or effectiveness. Cypress is not liable, in whole or in part, and you shall and hereby do release Cypress from any claim, damage, or other liability arising from or related to all Unintended Uses of Cypress products. You shall indemnify and hold Cypress harmless from and against all claims, costs, damages, and other liabilities, including claims for personal injury or death, arising from or related to any Unintended Uses of Cypress products.

Cypress, the Cypress logo, Spansion, the Spansion logo, and combinations thereof, PSoC, CapSense, EZ-USB, F-RAM, and Traveo are trademarks or registered trademarks of Cypress in the United States and other countries. For a more complete list of Cypress trademarks, visit [cypress.com](http://cypress.com). Other names and brands may be claimed as property of their respective owners.

PSoC Designer, PSoC Creator, SmartSense, and CapSense Express are trademarks of Cypress Semiconductor Corporation.

# Contents



## Safety Information 5

<b>1. Introduction</b>	<b>7</b>
1.1 Kit Contents .....	7
1.2 PSoC Creator™ .....	9
1.3 Getting Started.....	9
1.4 Additional Learning Resources .....	10
1.4.1 PSoC Creator.....	11
1.4.2 PSoC Creator Code Examples .....	12
1.4.3 PSoC Creator Help .....	13
1.4.4 Technical Support.....	14
1.5 Documentation Conventions.....	14
<b>2. Software Installation</b>	<b>15</b>
2.1 Install Kit Software .....	15
2.2 Install Hardware.....	16
2.3 Install Software .....	16
2.4 Uninstall Software .....	17
2.5 Develop Code Fast and Easy with Code Examples .....	17
2.6 Open an Example Project in PSoC Creator.....	19
<b>3. Kit Operation</b>	<b>21</b>
3.1 Pioneer Kit USB Connection.....	22
3.2 Programming and Debugging PSoC 4 .....	23
3.2.1 Using the Onboard PSoC 5LP Programmer and Debugger .....	23
3.2.2 Using CY8CKIT-002 MiniProg3 Programmer and Debugger .....	25
3.3 USB-UART Bridge .....	26
3.4 USB-I2C Bridge .....	28
3.5 Updating the Onboard Programmer Firmware .....	29
<b>4. Hardware</b>	<b>31</b>
4.1 Board Details .....	31
4.2 Theory of Operation.....	33
4.3 Functional Description .....	34
4.3.1 PSoC 4.....	34
4.3.2 PSoC 5LP .....	35
4.3.3 Power Supply System.....	37
4.3.4 Programming Interface.....	39
4.3.5 Arduino Compatible Headers (J1, J2, J3, J4, and J12 - unpopulated).....	40
4.3.6 Digilent Pmod Compatible Header (J5 - unpopulated).....	42
4.3.7 PSoC 5LP GPIO Header (J8) .....	43
4.3.8 CapSense Slider .....	44

4.3.9	Pioneer Board LEDs .....	45
4.3.10	Push Buttons .....	46
<b>5.</b>	<b>Code Examples</b>	<b>47</b>
5.1	Project: Blinking LED .....	50
5.1.1	Project Description .....	50
5.1.2	Hardware Connections .....	50
5.1.3	Flow Chart .....	51
5.1.4	Verify Output .....	51
5.2	Project: PWM .....	52
5.2.1	Project Description .....	52
5.2.2	Hardware Connections .....	52
5.2.3	Flow Chart .....	53
5.2.4	Verify Output .....	53
5.3	Project: Deep Sleep .....	54
5.3.1	Project Description .....	54
5.3.2	Hardware Connections .....	54
5.3.3	Flow Chart .....	55
5.3.4	Verify Output .....	55
5.4	Project: CapSense .....	56
5.4.1	CapSense (Without Tuning) .....	56
5.4.2	CapSense (With Tuning) .....	59
<b>6.</b>	<b>Advanced Topics</b>	<b>66</b>
6.1	Using PSoC 5LP as USB-UART Bridge .....	66
6.2	Using PSoC 5LP as USB-I2C Bridge .....	79
6.3	Developing Applications for PSoC 5LP .....	88
6.3.1	Building a Bootloadable Project for PSoC 5LP .....	88
6.3.2	Building a Normal Project for PSoC 5LP .....	96
6.4	PSoC 5LP Factory Program Restore Instructions .....	97
6.4.1	PSoC 5LP is Programmed with a Bootloadable Application .....	97
6.4.2	PSoC 5LP is Programmed with a Standard Application .....	102
6.5	Using $\mu$ C/Probe Tool .....	104
6.5.1	CapSense Example Project .....	105
6.5.2	PWM Example project .....	111
<b>A.</b>	<b>Appendix</b>	<b>113</b>
A.1	CY8CKIT-042 Schematics .....	113
A.2	Pin Assignment Table .....	116
A.3	Program and Debug Headers .....	119
A.4	Use of Zero-ohm Resistors and No Load .....	120
A.5	Error in Firmware/Status Indication in Status LED .....	120
A.6	Bill of Materials (BOM) .....	121
A.7	Regulatory Compliance Information .....	123
A.8	Migrating projects across different Pioneer series kits .....	124
	<b>Revision History</b>	<b>128</b>

# Safety Information



## Regulatory Compliance

The CY8CKIT-042 PSoC<sup>®</sup> 4 Pioneer Kit is intended for use as a development platform for hardware or software in a laboratory environment. The board is an open system design, which does not include a shielded enclosure. Due to this reason, the board may cause interference to other electrical or electronic devices in close proximity. In a domestic environment, this product may cause radio interference. In such cases, the user may be required to take adequate preventive measures. Also, this board should not be used near any medical equipment or RF devices.

Attaching additional wiring to this product or modifying the product operation from the factory default may affect its performance and cause interference with other apparatus in the immediate vicinity. If such interference is detected, suitable mitigating measures should be taken.

The CY8CKIT-042 as shipped from the factory has been verified to meet with requirements of CE as a Class A product.



The CY8CKIT-042 contains electrostatic discharge (ESD) sensitive devices. Electrostatic charges readily accumulate on the human body and any equipment, and can discharge without detection. Permanent damage may occur on devices subjected to high-energy discharges. Proper ESD precautions are recommended to avoid performance degradation or loss of functionality. Store unused CY8CKIT-042 boards in the protective shipping package.



### End-of-Life/Product Recycling

This kit has an end-of-life cycle five years from the date of manufacturing mentioned on the back of the box. Contact your nearest recycler for discarding the kit.

## General Safety Instructions

### ESD Protection

ESD can damage boards and associated components. Cypress recommends that the user perform procedures only at an ESD workstation. If an ESD workstation is not available, use appropriate ESD protection by wearing an antistatic wrist strap attached to the chassis ground (any unpainted metal surface) on the board when handling parts.

### Handling Boards

CY8CKIT-042 boards are sensitive to ESD. Hold the board only by its edges. After removing the board from its box, place it on a grounded, static free surface. Use a conductive foam pad if available. Do not slide board over any surface.

# 1. Introduction



Thank you for your interest in the PSoC<sup>®</sup> 4 Pioneer Kit. The kit is designed as an easy-to-use and inexpensive development kit, showcasing the unique flexibility of the PSoC 4 architecture. Designed for flexibility, this kit offers footprint-compatibility with several third-party Arduino<sup>™</sup> shields. This kit has a provision to populate an extra header to support Digilent<sup>®</sup> Pmod<sup>™</sup> peripheral modules. In addition, the board features a CapSense<sup>®</sup> slider, an RGB LED, a push button switch, an integrated USB programmer, a program and debug header, and USB-UART/I2C bridges. This kit supports either 5 V or 3.3 V as power supply voltages.

The PSoC 4 Pioneer Kit is based on the PSoC 4200 device family, delivering a programmable platform for a wide range of embedded applications. The PSoC 4 is a scalable and reconfigurable platform architecture for a family of mixed-signal programmable embedded system controllers with an ARM<sup>®</sup> Cortex<sup>™</sup>-M0 CPU. It combines programmable and reconfigurable analog and digital blocks with flexible automatic routing.

## 1.1 Kit Contents

The PSoC 4 Pioneer kit contains:

- PSoC 4 Pioneer board
- Quick Start Guide
- USB Standard-A to Mini-B cable
- Six jumper wires

Figure 1-1. Kit Contents

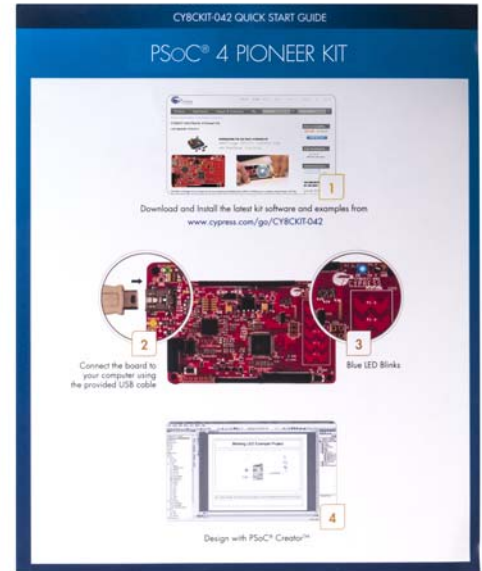
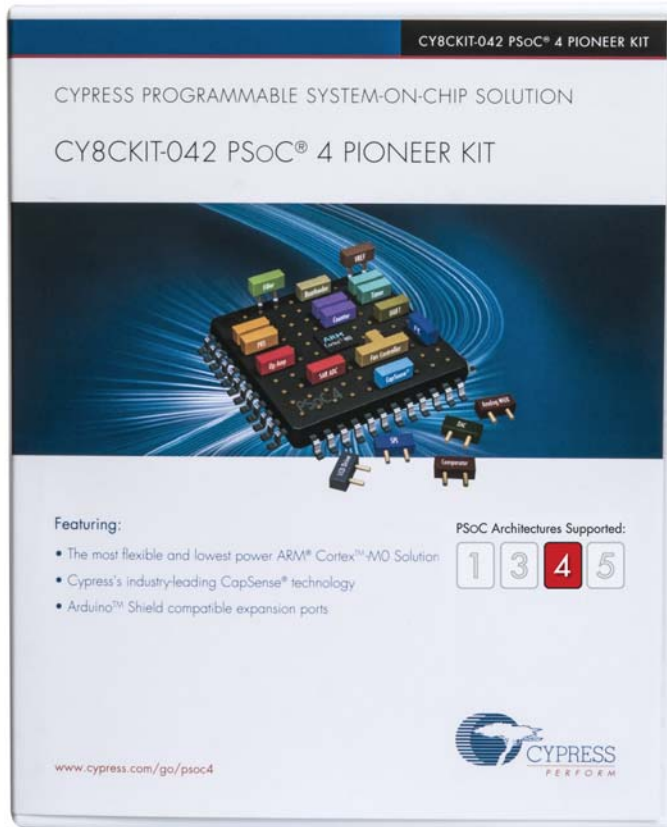

Inspect the contents of the kit; if you find any part missing, contact your nearest Cypress sales office for help: [www.cypress.com/go/support](http://www.cypress.com/go/support).



## 1.2 PSoC Creator™

PSoC Creator is a state-of-the-art, easy-to-use integrated design environment (IDE). It introduces revolutionary hardware and software co-design, powered by a library of pre-verified and pre-characterized PSoC Components™.

With PSoC Creator, you can:

- Drag and drop PSoC components to build a schematic of your custom design
- Automatically place and route components and configure GPIOs
- Develop and debug firmware using the included component APIs

PSoC Creator also enables you to tap into an entire tools ecosystem with integrated compiler chains and production programmers for PSoC devices.

For more information, visit [www.cypress.com/Creator](http://www.cypress.com/Creator).

## 1.3 Getting Started

This guide helps you to get acquainted with the PSoC 4 Pioneer Kit. The [Software Installation chapter on page 15](#) describes the installation of the kit software. The [Kit Operation chapter on page 21](#) explains how to program the PSoC 4 with a programmer and debugger – either the onboard PSoC 5LP or the external MiniProg3 (CY8CKIT-002). The [Hardware chapter on page 31](#) details the hardware operation. The [Code Examples chapter on page 47](#) describes the code examples. The [Advanced Topics chapter on page 66](#) deals with topics such as building projects for PSoC 5LP, USB-UART functionality, and USB-I2C functionality of PSoC 5LP. The [Appendix on page 113](#) provides the schematics, pin assignment, use of zero-ohm resistors, troubleshooting, and the bill of materials (BOM).

## 1.4 Additional Learning Resources

Cypress provides a wealth of data at [www.cypress.com](http://www.cypress.com) to help you to select the right PSoC device for your design, and to help you to quickly and effectively integrate the device into your design. For a comprehensive list of resources, see [KBA86521](#), [How to Design with PSoC 3](#), [PSoC 4](#), and [PSoC 5LP](#). The following is an abbreviated list for PSoC 4:

- **Overview:** [PSoC Portfolio](#), [PSoC Roadmap](#)
- **Product Selectors:** [PSoC 1](#), [PSoC 3](#), [PSoC 4](#), or [PSoC 5LP](#). In addition, PSoC Creator includes a device selection tool.
- **Datasheets:** Describe and provide electrical specifications for the [PSoC 4000](#), [PSoC 4100](#), and [PSoC 4200](#) device families.
- **CapSense Design Guide:** Learn how to design capacitive touch-sensing applications with the PSoC 4 family of devices.
- **Application Notes and Code Examples:** Cover a broad range of topics, from basic to advanced level. Many of the application notes include code examples. Visit the [PSoC 3/4/5 Code Examples](#) webpage for a list of all available PSoC Creator code examples. For accessing code examples from within PSoC Creator – see [PSoC Creator Code Examples on page 12](#).
- **Technical Reference Manuals (TRM):** Provide detailed descriptions of the architecture and registers in each PSoC 4 device family.
- **Development Kits:**
  - [CY8CKIT-042](#) and [CY8CKIT-040](#), PSoC 4 Pioneer Kits, are easy-to-use and inexpensive development platforms. These kits include connectors for Arduino compatible shields and Digilent Pmod daughter cards.
  - [CY8CKIT-049](#) is a very low-cost prototyping platform for sampling PSoC 4 devices.
  - [CY8CKIT-001](#) is a common development platform for all PSoC family devices.
- The [MiniProg3](#) device provides an interface for flash programming and debug.
- **Knowledge Base Articles (KBA):** Provide design and application tips from experts on the devices/kits. For instance, [KBA93541](#), explains how to use [CY8CKIT-049](#) to program another PSoC 4.

### 1.4.1 PSoC Creator

**PSoC Creator** is a free Windows-based integrated design environment (IDE). It enables concurrent hardware and firmware design of systems based on PSoC 3, PSoC 4, and PSoC 5LP. See [Figure 1-2](#) – with PSoC Creator, you can:

1. Drag and drop Components to build your hardware system design in the main design workspace
2. Codesign your application firmware with the PSoC hardware
3. Configure Components using configuration tools
4. Explore the library of 100+ Components
5. Access Component datasheets

Figure 1-2. PSoC Creator Features

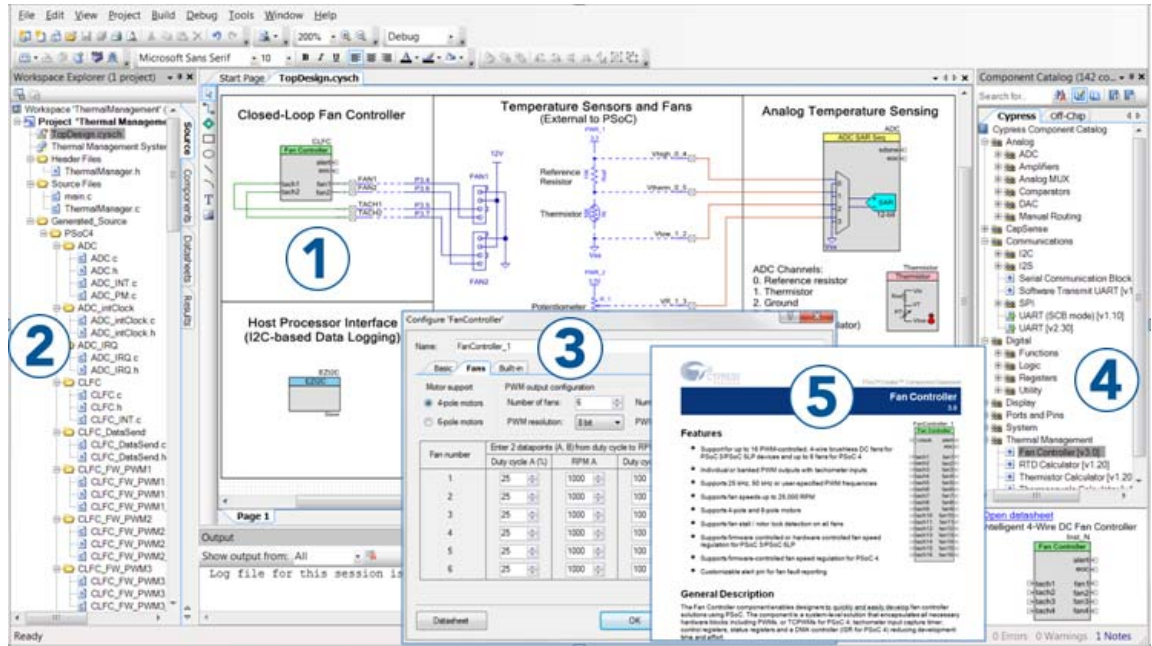

Visit [PSoC Creator training page](#) for video tutorials on learning and using PSoC Creator.

## 1.4.2 PSoC Creator Code Examples

PSoC Creator includes a large number of code example projects. These projects are accessible from the PSoC Creator Start Page, as [Figure 1-3](#) shows.

Example projects can speed up your design process by starting you off with a complete design, instead of a blank page. The example projects also show how PSoC Creator Components can be used for various applications. Code examples and datasheets are included, as [Figure 1-4 on page 13](#) shows.

In the Find Example Project dialog shown in [Figure 1-4 on page 13](#), you have several options:

- Filter for examples based on device family or keyword
- Select from the menu of examples offered based on the Filter Options
- View the datasheet for the selection (on the **Documentation** tab)
- View the code example for the selection. You can copy and paste code from this window to your project, which can help speed up code development, or
- Create a new workspace for the example project. This can speed up your design process by starting you off with a complete, basic design. You can then adapt that design to your application.

Figure 1-3. Code Examples in PSoC Creator

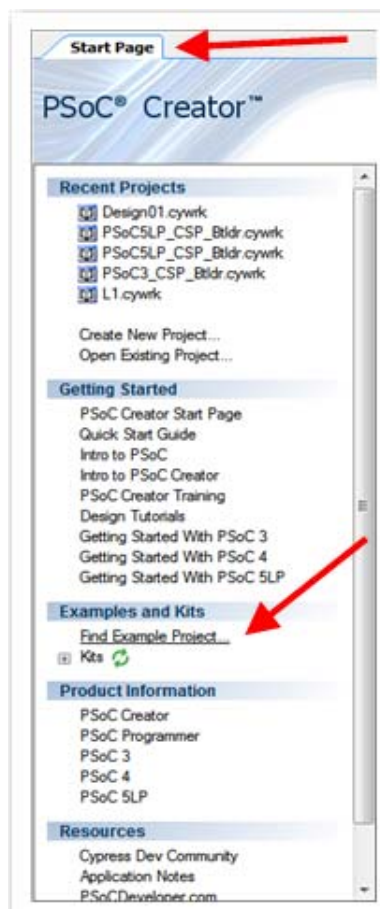
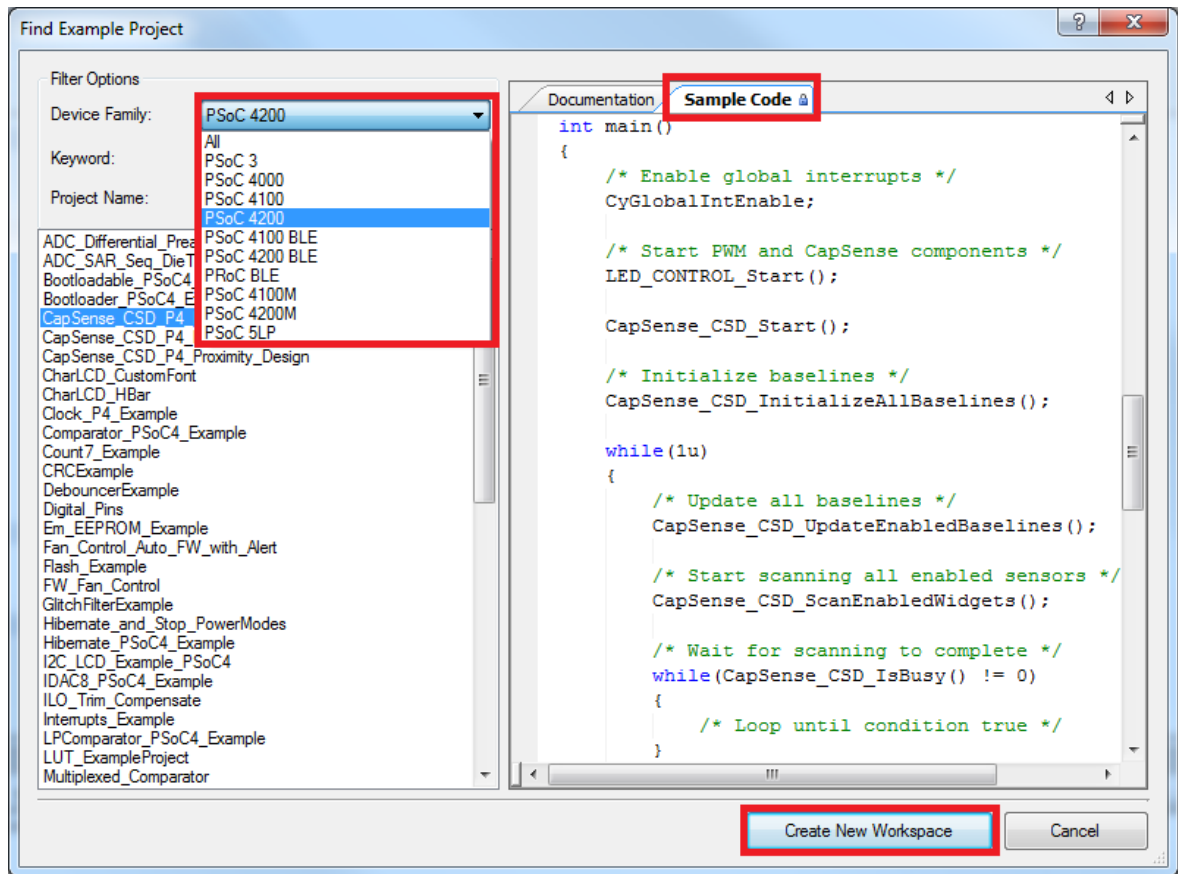

Figure 1-4. Code Example Projects with Sample Code



### 1.4.3 PSoC Creator Help

Visit the [PSoC Creator home page](#) to download the latest version of PSoC Creator. Then, launch PSoC Creator and navigate to the following items:

- **Quick Start Guide:** Choose **Help > Documentation > Quick Start Guide**. This guide gives you the basics for developing PSoC Creator projects.
- **Simple Component example projects:** Choose **File > Open > Example projects**. These example projects demonstrate how to configure and use PSoC Creator Components.
- **Starter designs:** Choose **File > New > Project > PSoC 4100 / PSoC 4200 Starter Designs**. These starter designs demonstrate the unique features of PSoC 4.
- **System Reference Guide:** Choose **Help > System Reference > System Reference Guide**. This guide lists and describes the system functions provided by PSoC Creator.
- **Component datasheets:** Right-click a Component and select “Open Datasheet.” Visit the [PSoC 4 Component Datasheets](#) page for a list of all PSoC 4 Component datasheets.
- **Document Manager:** PSoC Creator provides a document manager to help you to easily find and review document resources. To open the document manager, choose the menu item **Help > Document Manager**.

### 1.4.4 Technical Support

If you have any questions, our technical support team is happy to assist you. You can create a support request on the [Cypress Technical Support](#) page.

If you are in the United States, you can talk to our technical support team by calling our toll-free number: +1-800-541-4736. Select option 2 at the prompt.

You can also use the following support resources if you need quick assistance.

- [Self-help](#)
- [Local Sales Office Locations](#)

## 1.5 Documentation Conventions

Table 1-1. Document Conventions for Guides

Convention	Usage
Courier New	Displays file locations, user entered text, and source code: C:\ ..cd\icc\
<i>Italics</i>	Displays file names and reference documentation: Read about the <i>sourcefile.hex</i> file in the <i>PSoC Creator User Guide</i> .
[Bracketed, Bold]	Displays keyboard commands in procedures: [Enter] or [Ctrl] [C]
File > Open	Represents menu paths: File > Open > New Project
<b>Bold</b>	Displays commands, menu paths, and icon names in procedures: Click the <b>File</b> icon and then click <b>Open</b> .
Times New Roman	Displays an equation: 2 + 2 = 4
Text in gray boxes	Describes cautions or unique functionality of the product.

## 2. Software Installation



### 2.1 Install Kit Software

Follow these steps to install the PSoC 4 Pioneer Kit software:

1. Download and install the PSoC 4 Pioneer Kit software from [www.cypress.com/go/CY8CKIT-042](http://www.cypress.com/go/CY8CKIT-042).
2. Select the folder to install the CY8CKIT-042 related files. Choose the directory and click **Next**.

Figure 2-1. Installation Folder

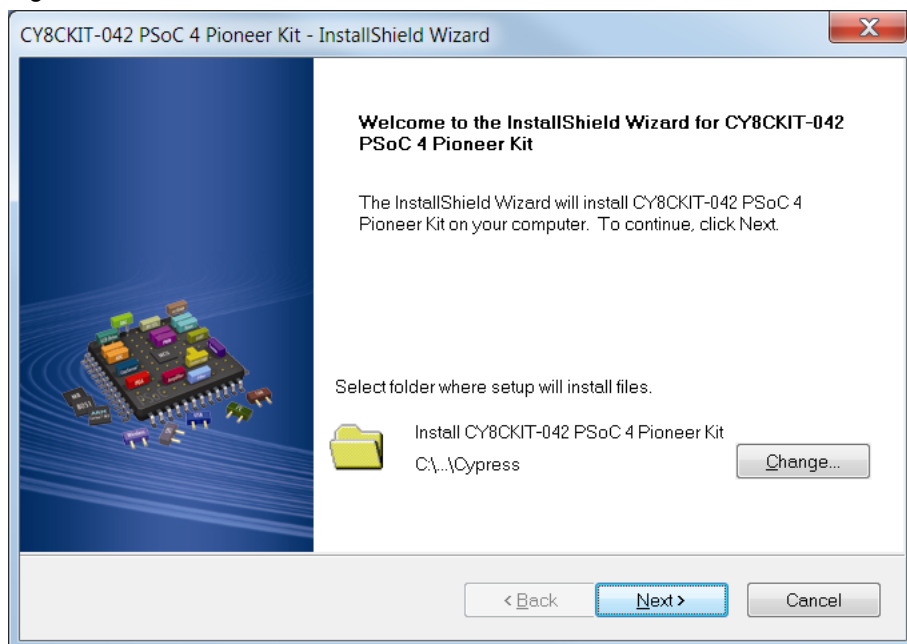

3. Select the installation type and click **Next**.

Figure 2-2. Installation Type Options

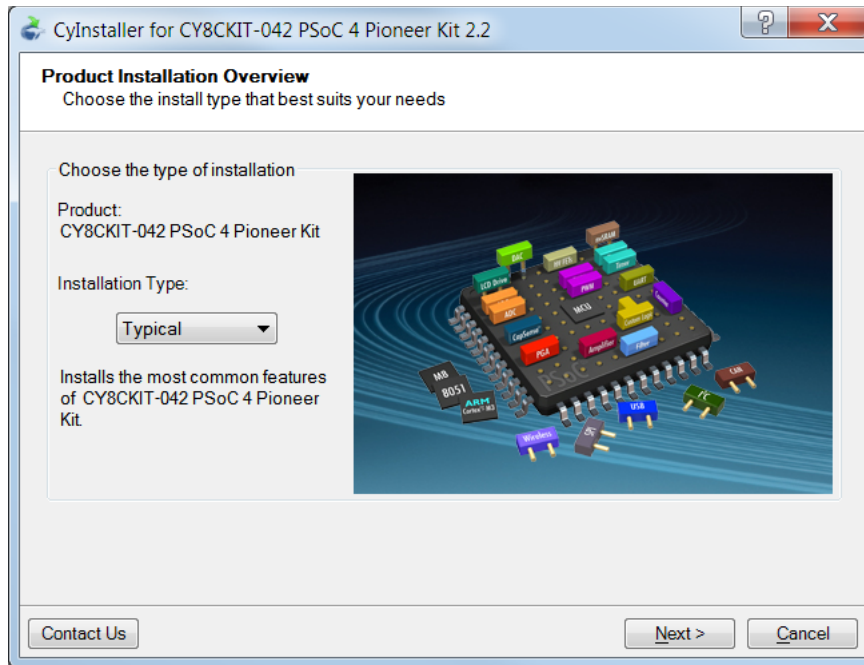

4. Read and accept the End-User Licence Agreement and click **Next** to proceed with the installation.

After the installation is complete, the kit contents are available at the following location:  
`<Install_Directory>\CY8CKIT-042 PSoC 4 Pioneer Kit\<version>`

**Note** For Windows 7 users, the installed files and the folder are read-only. To change the property, right-click the folder and select **Properties > Attributes**; disable the **Read-only** radio button. Click **Apply** and **OK** to close the window.

## 2.2 Install Hardware

There is no additional hardware installation required for this kit.

## 2.3 Install Software

When installing the PSoC 4 Pioneer Kit, the installer checks if the required software is installed in the system. If the required applications are not installed, then the installer prompts you to download and install them.

The following software is required:

- PSoC Creator 3.2 Service Pack 1 or later: Download the latest software from [www.cypress.com/go/Creator](http://www.cypress.com/go/Creator).
- PSoC Programmer 3.23.1 or later: Download the latest software from [www.cypress.com/go/Programmer](http://www.cypress.com/go/Programmer).
- Code examples: After the kit installation is complete, the code examples are available in the kit firmware folder. Download the CD ISO image or the setup files to install the kit from [www.cypress.com/go/CY8CKIT-042](http://www.cypress.com/go/CY8CKIT-042).



## 2.4 Uninstall Software

The software can be uninstalled using one of the following methods:

- Go to **Start > All Programs > Cypress > Cypress Update Manager > Cypress Update Manager**; select the **Uninstall** button.
- Go to **Start > Control Panel > Programs and Features**; select the **Uninstall/Change** button.

## 2.5 Develop Code Fast and Easy with Code Examples

PSoC Creator provides several example projects that make code development fast and easy. To access these projects, click **Find Example Project...** under the **Example and Kits** section in the **Start Page** of PSoC Creator or navigate to the Creator tool bar and select **File > Example Project**.

Figure 2-3. Find Example Project

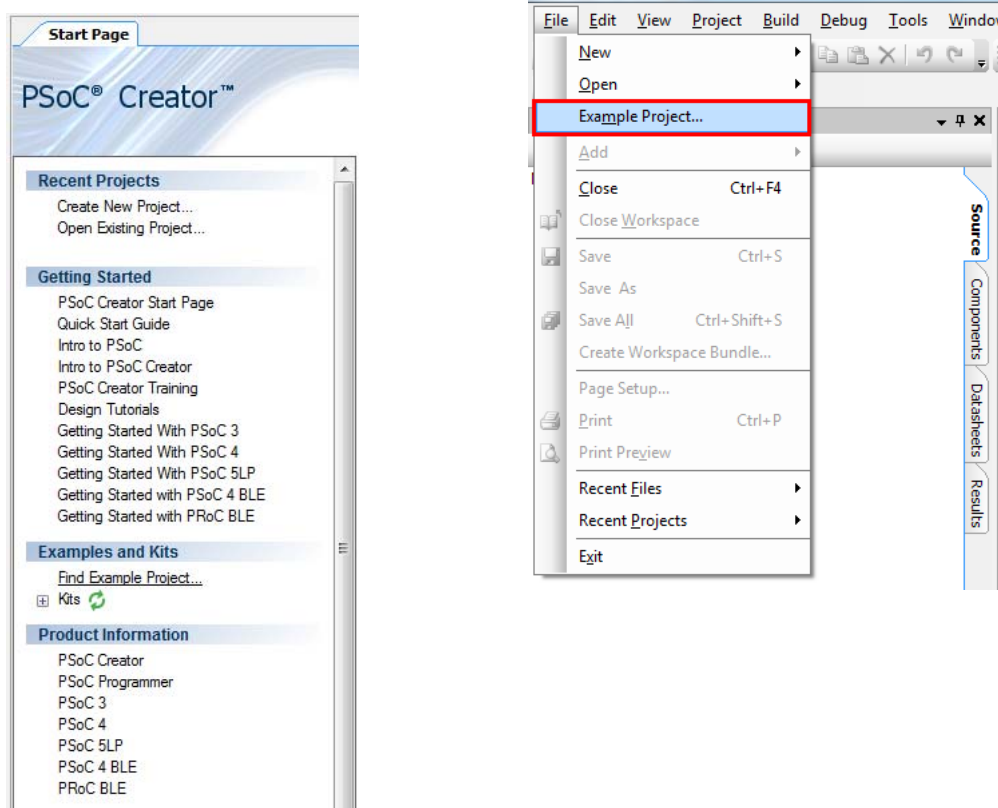

The **Find Example Project** section has various filters that help to locate the most relevant project.

PSoC Creator also provides several starter designs for each device family. These designs highlight features that are unique to each PSoC family. They provide users with a starting place instead of creating a new empty design. These starter projects come loaded with various pre-selected components. To use a starter design, navigate to **File > New > Project** and select the design required.

Figure 2-4. Starter Designs

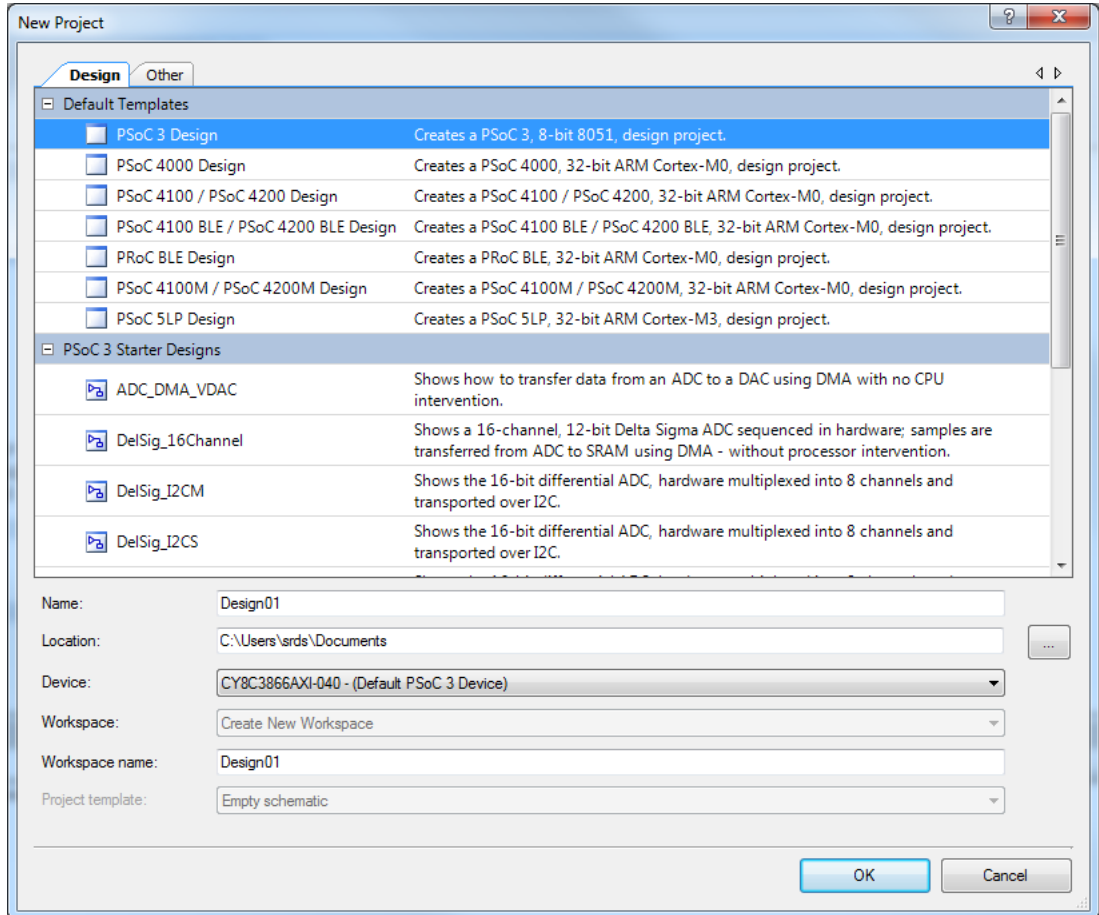

In addition to the example projects and starter designs that are available within PSoC Creator, Cypress continuously strives to provide the best support. Click [here](#) to view a growing list of application notes for PSoC 3, PSoC 4, and PSoC 5LP.

## 2.6 Open an Example Project in PSoC Creator

1. Launch PSoC Creator from the Start menu.

Figure 2-5. PSoC Creator Start Page

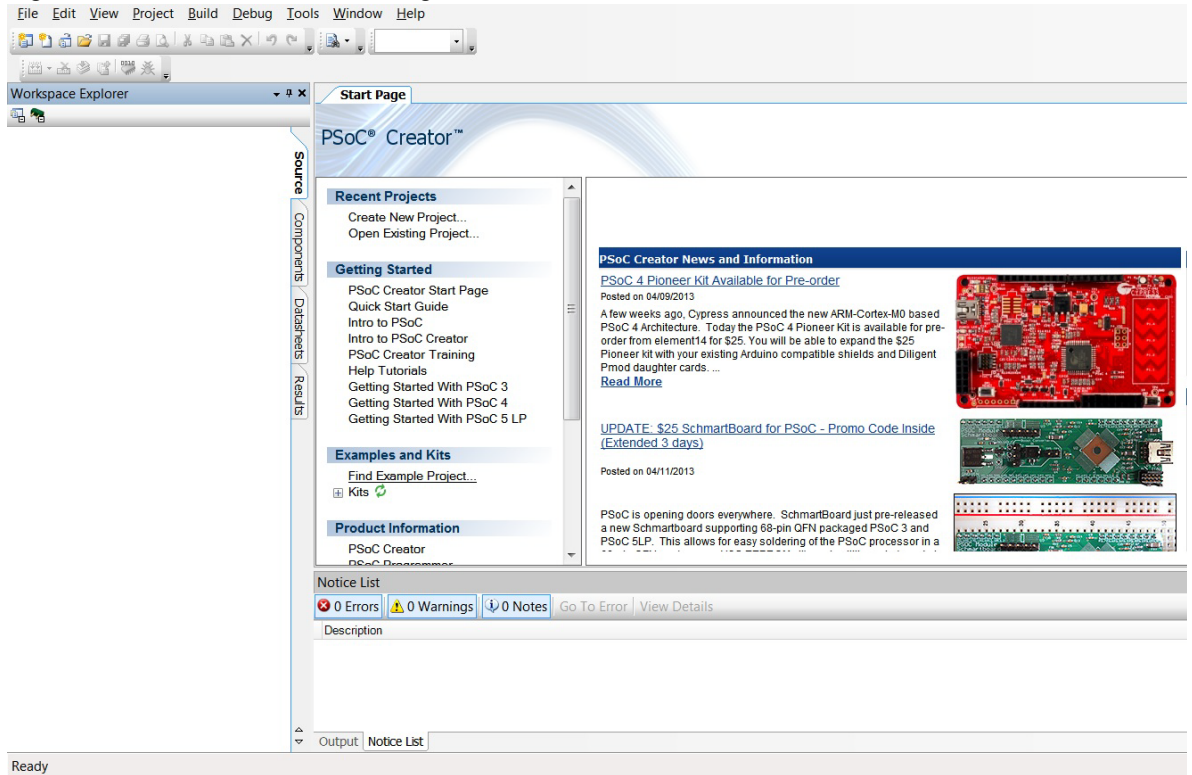

2. Open the example project from the Start Page by clicking <Project.cywrk> present under **Examples and Kits** > **Kits** > **CY8CKIT-042**.

Figure 2-6. Open Example Project

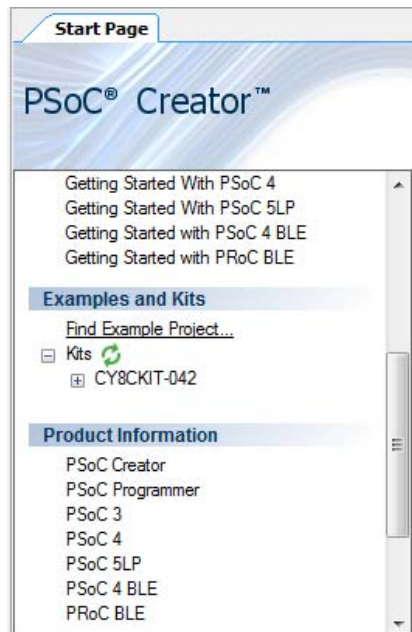

- The example project opens and displays the project files in the Workspace Explorer. Subsequent sections of this user guide describe how to build, program, and understand the example projects supported in this kit.

Figure 2-7. Workspace Explorer

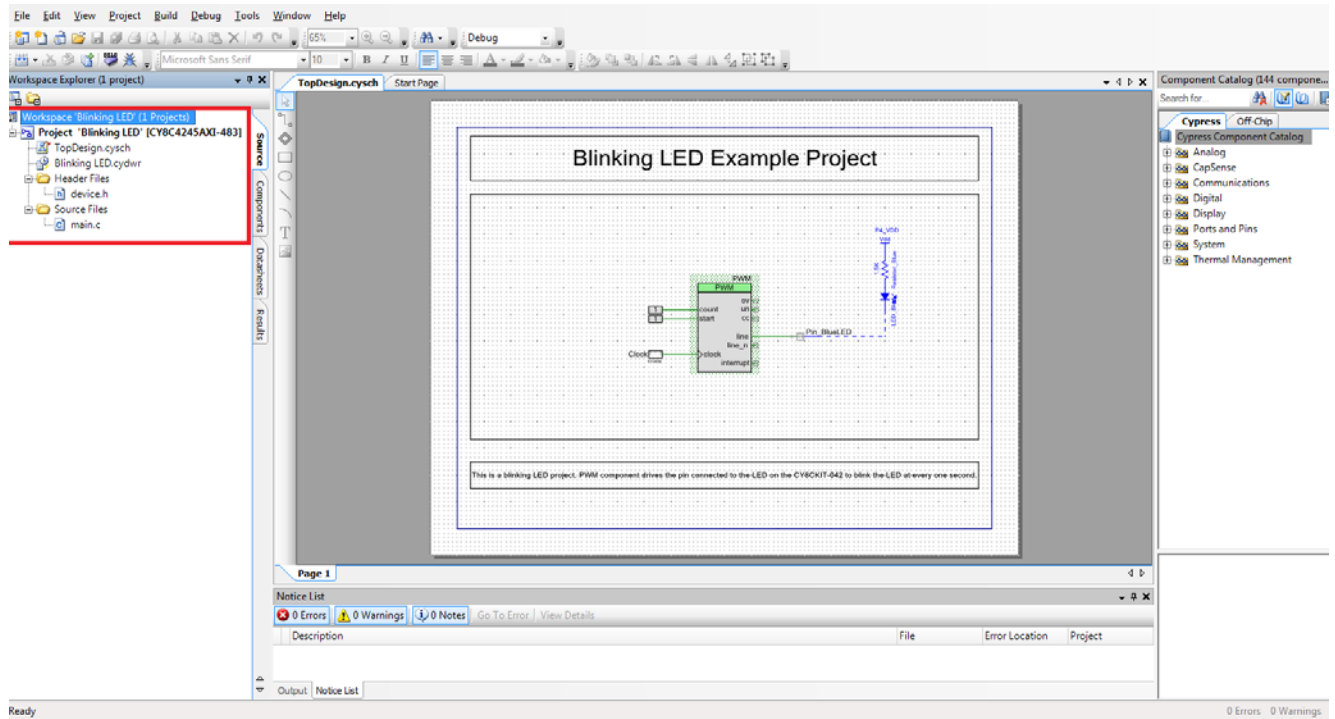

# 3. Kit Operation



The PSoC 4 Pioneer Kit can be used to develop applications using the PSoC 4 family of devices and the Arduino shields and Digilent Pmod daughter cards. Figure 3-1 is an image of the PSoC 4 Pioneer board with a markup of the onboard components.

Figure 3-1. PSoC 4 Pioneer Board

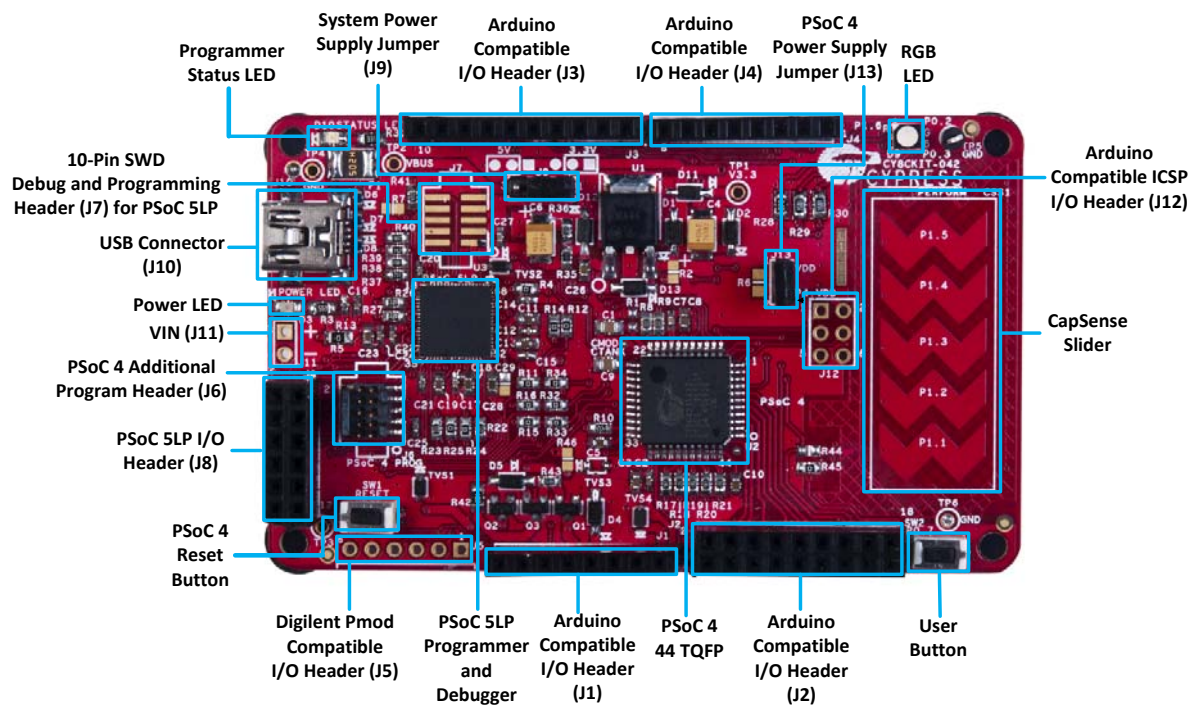

### 3.1 Pioneer Kit USB Connection

The PSoC 4 Pioneer Kit connects to the PC over a USB interface. The kit enumerates as a composite device and three separate devices appear under the Device Manager window in the Windows operating system.

Table 3-1. PSoC 4 Pioneer Kit in Device Manager After Enumeration

Port	Description
USB Composite Device	Composite device
USB Input Device	USB-I <sup>2</sup> C bridge, KitProg command interface
KitProg	Programmer and debugger
KitProg USB-UART	USB-UART bridge, which appears as the COM# port

Figure 3-2. KitProg Driver Installation

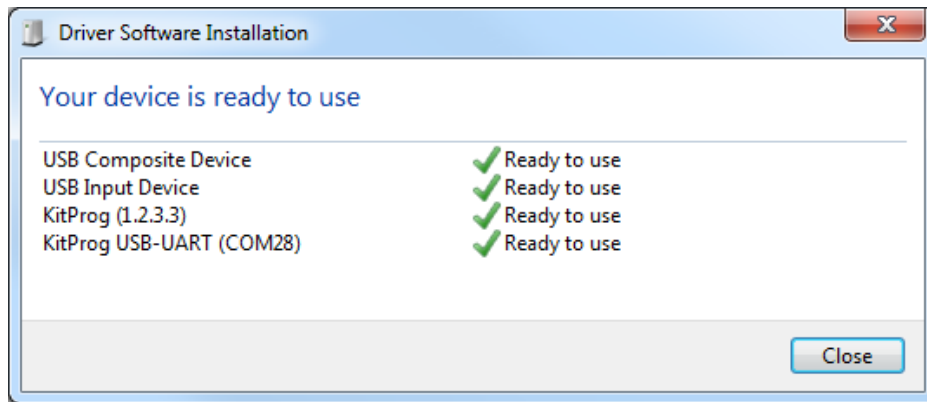

### 3.2 Programming and Debugging PSoC 4

The kit allows programming and debugging of the PSoC 4 device in two modes:

- Using the onboard PSoC 5LP programmer and debugger
- Using a CY8CKIT-002 MiniProg3 programmer and debugger

#### 3.2.1 Using the Onboard PSoC 5LP Programmer and Debugger

The default programming interface for the kit is a USB-based, onboard programming interface. Before trying to program the device, PSoC Creator and PSoC Programmer must be installed. See [Install Software on page 16](#) for information on installing the kit software.

1. To program the device, plug the USB cable into the programming USB connector J10, as shown in [Figure 3-3](#). The kit will enumerate as a composite device. See [Pioneer Kit USB Connection on page 22](#) for details.

Figure 3-3. Connect USB Cable to J10

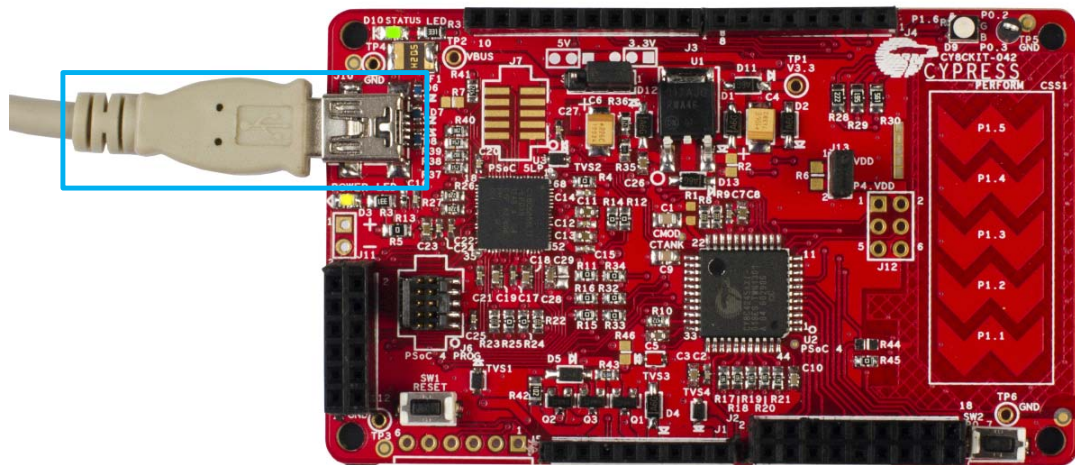

2. The onboard PSoC 5LP uses serial wire debug (SWD) to program the PSoC 4 device. See [Figure 3-4](#) for this implementation.

Figure 3-4. SWD Programming PSoC 4 Using PSoC 5LP

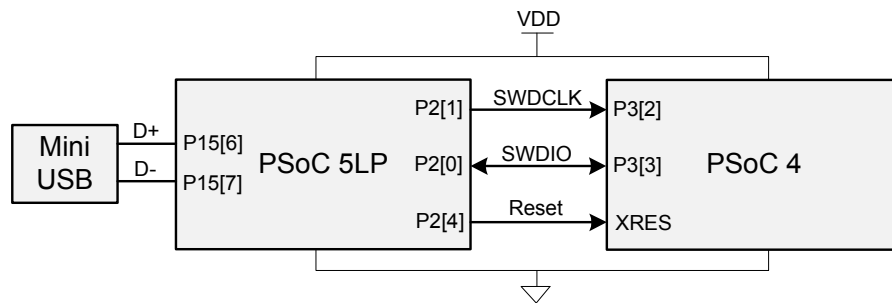

- The Pioneer Kit's onboard programmer will enumerate on the PC and in the software tools as **KitProg**. Load an example project in PSoC Creator (such as the project described in [Install Software on page 16](#)) and initiate the build by clicking **Build > Build Project** or **[Shift]+[F6]**.

Figure 3-5. Build Project in PSoC Creator

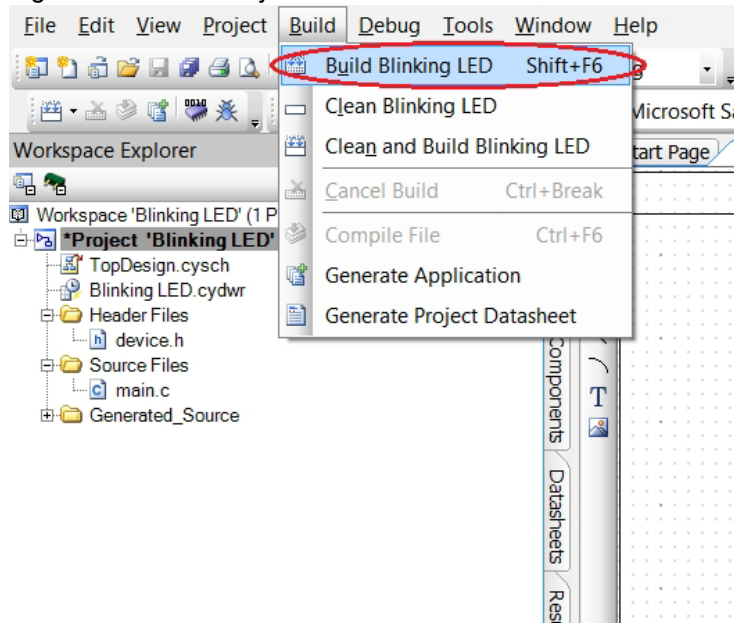

- After the project is built without errors and warnings, select **Debug > Program** or **[Ctrl]+[F5]** to program the device.

Figure 3-6. Program Device from PSoC Creator

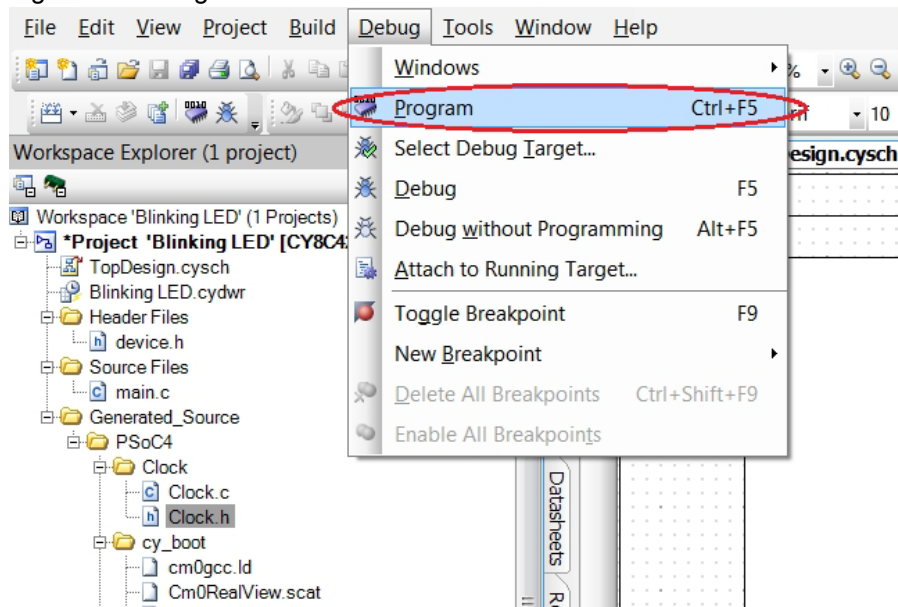

The onboard programmer supports only the RESET programming mode. When using the onboard programmer, the board can either be powered by the USB (VBUS) or by an external source such as an Arduino shield. If the board is already powered from another source, plugging in the USB programmer does not damage the board.



### 3.2.2 Using CY8CKIT-002 MiniProg3 Programmer and Debugger

The PSoC 4 on the Pioneer Kit can also be programmed using a MiniProg3 (CY8CKIT-002). To use MiniProg3 for programming, use the J6 connector on the board, as shown in [Figure 3-7](#). With MiniProg3, programming is similar to the onboard programmer; however, the setup enumerates as a MiniProg3. Only the RESET programming mode is available.

The board can also be powered from the MiniProg3. To do this, select **Tool > Options**. In the Options window, expand **Program and Debug > Port Configuration**; click **MiniProg3** and select the settings shown in [Figure 3-8](#). Click **Debug > Program** to program and power the board.

**Note:** The CY8CKIT-002 MiniProg3 is not part of the PSoC 4 Pioneer Kit contents. It can be purchased from the [Cypress Online Store](#).

Figure 3-7. PSoC 4 Programming/Debug Using MiniProg3

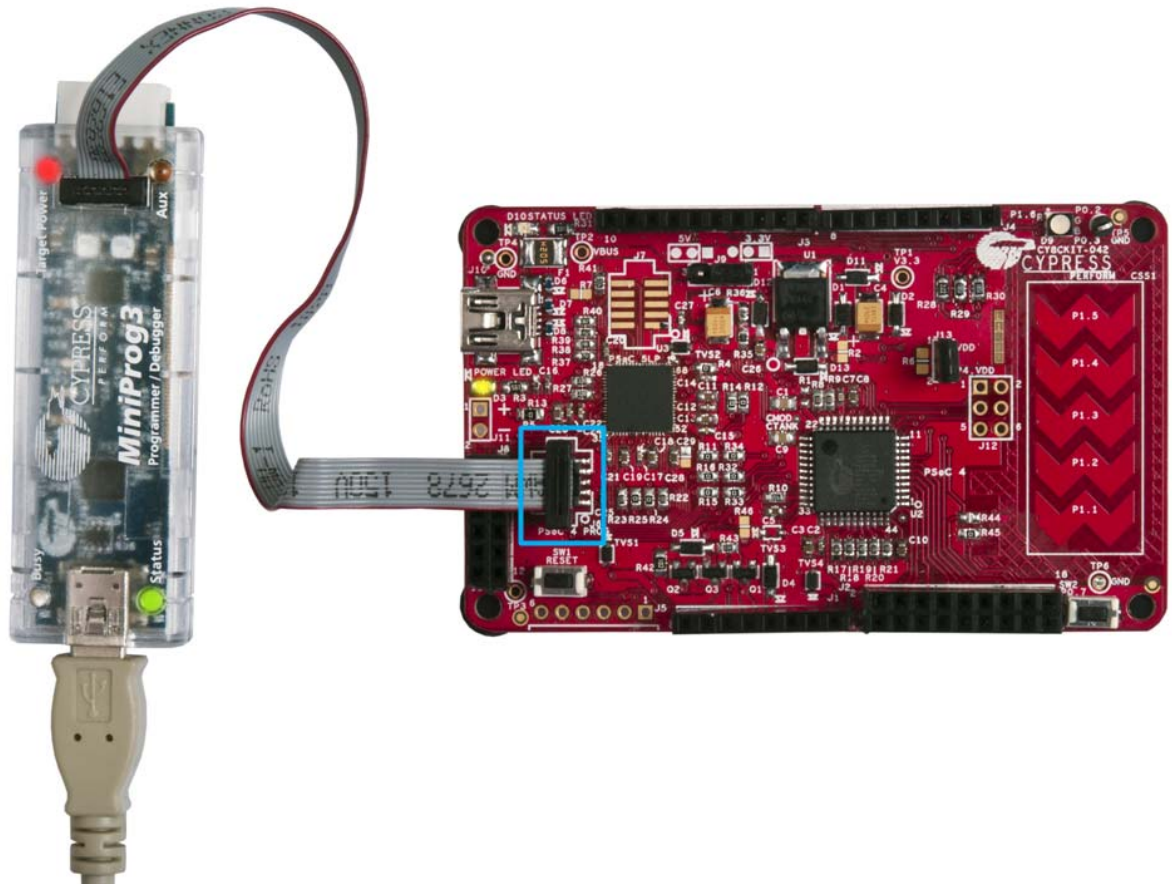
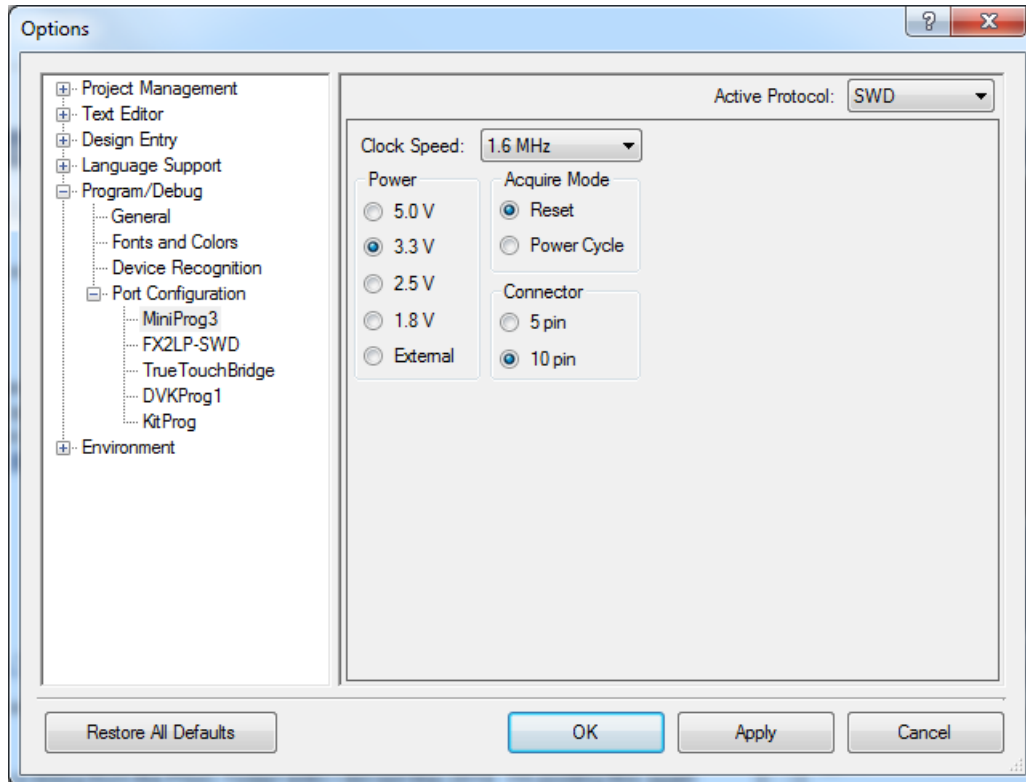

Figure 3-8. MiniProg3 Configuration



**Note:** See the [Programmer User Guide](#) for more information on programming using a MiniProg3.

### 3.3 USB-UART Bridge

The onboard PSoC 5LP can also act as a USB-UART bridge to transfer and receive data from the PSoC 4 device to the PC via the COM terminal software. When the USB mini-B cable is connected to J10 of the PSoC 4 Pioneer Kit, a device named **KitProg USBUART** is available under Ports (COM & LPT) in the device manager. For more details about the USB-UART functionality, see [Using PSoC 5LP as USB-UART Bridge on page 66](#).

To use the USB-UART functionality in the COM terminal software, select the corresponding COM port as the communication port for transferring data to and from the COM terminal software.

The UART lines from PSoC 5LP are brought to the P12[6] (J8\_9) and P12[7] (J8\_10) pins of header J8. This interface can be used to send or receive data from any PSoC 4 design that has a UART by connecting the pins on header J8 to the RX and TX pins assigned in PSoC 4. The UART can be used as an additional interface to debug designs. This bridge can also be used to interface with other external UART-based devices. [Figure 3-9](#) shows the connection between the RX and TX lines of the PSoC 5LP and PSoC 4. In this example, the PSoC 4 UART has been routed to the J3 header; the user must connect the wires between the PSoC 5LP RX and TX lines available on header J8.

Figure 3-9. Example RX and TX Line Connection of PSoC 5LP and PSoC 4

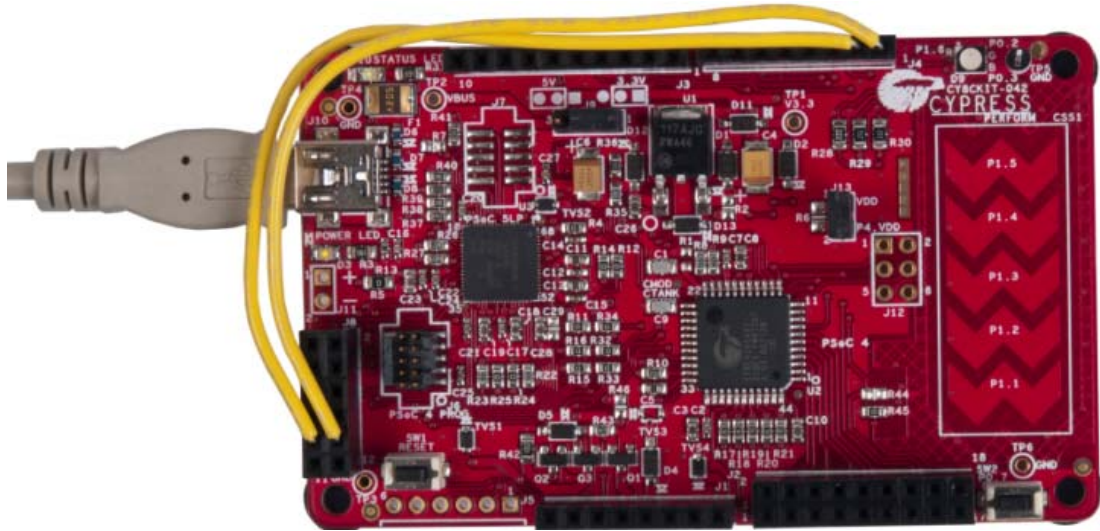

Table 3-2 lists the specifications supported by the USB-UART bridge.

Table 3-2. Specifications Supported by USB-UART Bridge

Parameter	Supported Values
Baud Rate	1200, 2400, 4800, 9600, 19200, 38400, 57600, and 115200
Data Bits	8
Parity	None
Stop Bits	1
Flow Control	None
File transfer protocols supported	Xmodem, 1K Xmodem, Ymodem, Kermit, and Zmodem (only speeds greater than 2400 baud).

### 3.4 USB-I2C Bridge

The PSoC 5LP also functions as a USB-I2C bridge. The PSoC 4 communicates with the PSoC 5LP using an I2C interface and the PSoC 5LP transfers the data over the USB to the USB-I2C software utility on the PC, called the Bridge Control Panel (BCP).

The BCP is available as part of the PSoC Programmer installation. This software can be used to send and receive USB-I2C data from the PSoC 5LP. When the USB mini-B cable is connected to header J10 on the Pioneer Kit, the **KitProg USB-I2C** is available under **Connected I2C/SPI/RX8 Ports** in the BCP.

Figure 3-10. Bridge Control Panel

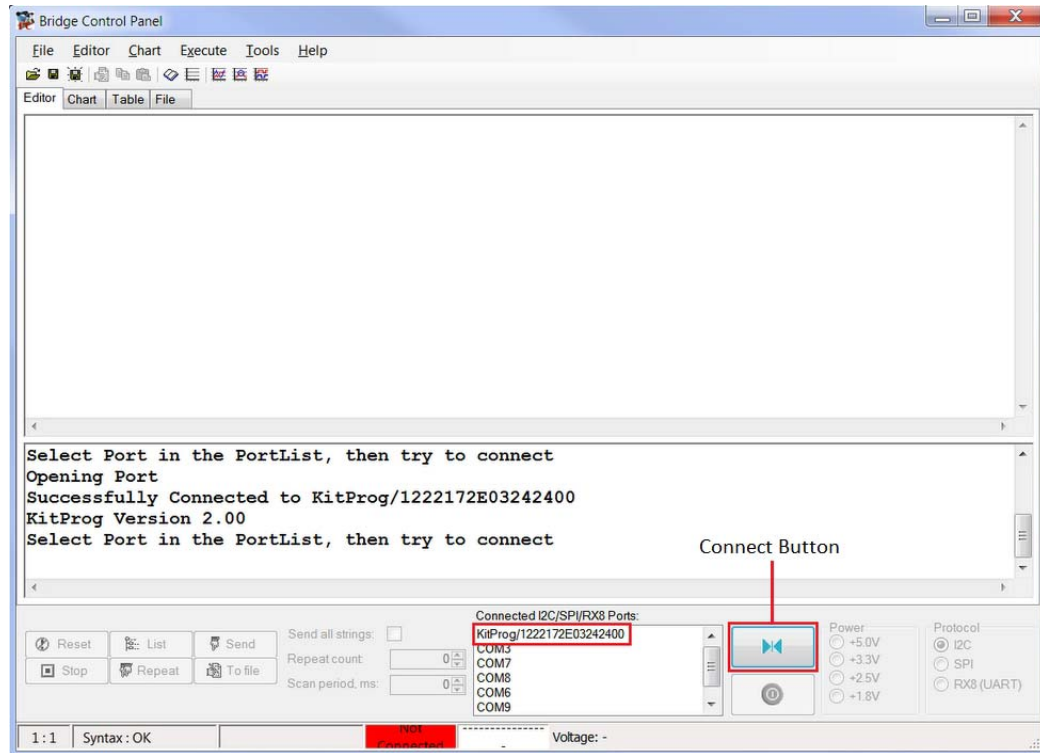

To use the USB\_I2C functionality, select the **KitProg USB-I2C** in the BCP. On successful connection, the **Connected** and **Powered** tabs turn green.

Figure 3-11. KitProg USB-I2C Connected in Bridge Control Panel

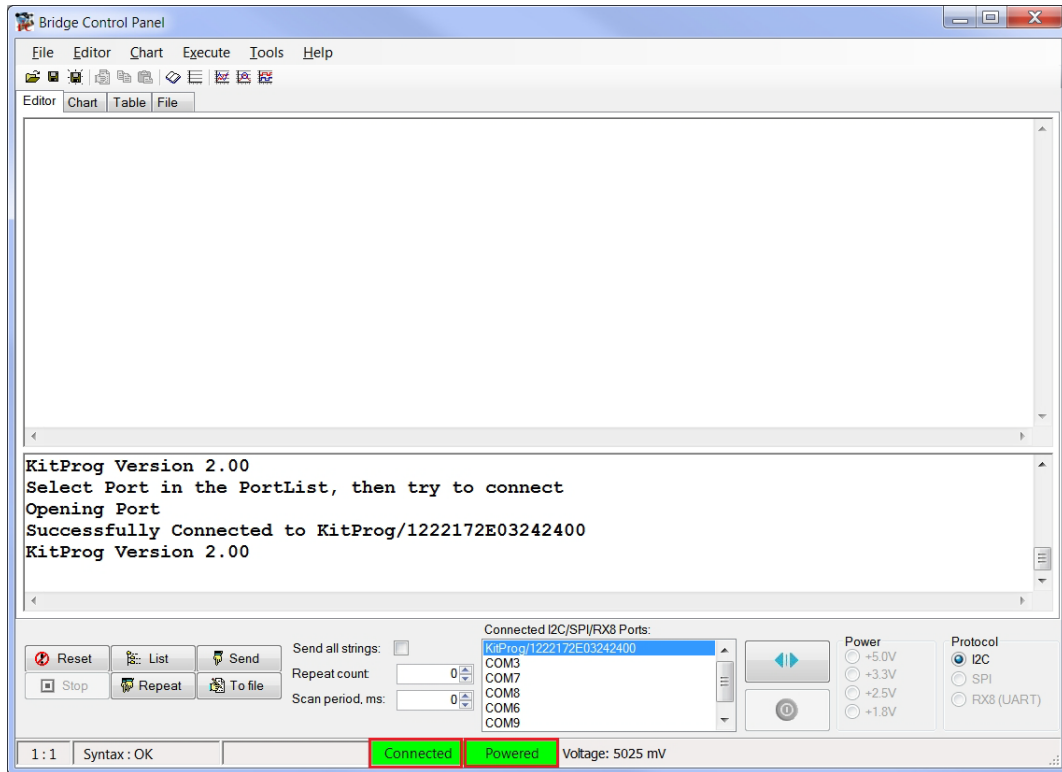

USB-I2C is implemented using the USB and I2C components of PSoC 5LP. The SCL (P12\_0) and SDA (P12\_1) lines from the PSoC 5LP are connected to SCL (P3\_0) and SDA (P3\_1) lines of the PSoC 4 I2C. The USB-I2C bridge currently supports I2C speed of 50 kHz, 100 kHz, 400 kHz, and 1 MHz.

Refer to [Using PSoC 5LP as USB-I2C Bridge on page 79](#) for building a project, which uses USB-I2C Bridge functionality.

### 3.5 Updating the Onboard Programmer Firmware

The firmware of the onboard programmer and debugger, PSoC 5LP, can be updated from PSoC Programmer. When a new firmware is available or when the KitProg firmware is corrupt (see [Error in Firmware/Status Indication in Status LED on page 120](#)), PSoC Programmer displays a warning indicating that new firmware is available.

Open PSoC Programmer from **Start > All Programs > Cypress > PSoC Programmer<version>**. When PSoC Programmer opens, a WARNING! window pops up saying that the programmer is currently out of date.

Figure 3-12. Firmware Update Warning

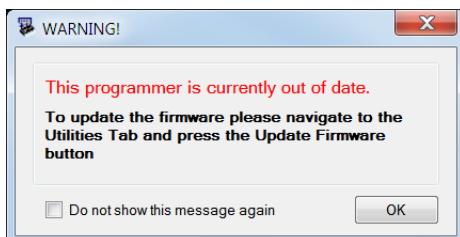

Click **OK** to close the window. On closing the warning window, the **Action and Results** window displays “Please navigate to the Utilities tab and click the Upgrade Firmware button”.

Figure 3-13. Upgrade Firmware Message in PSoC Programmer

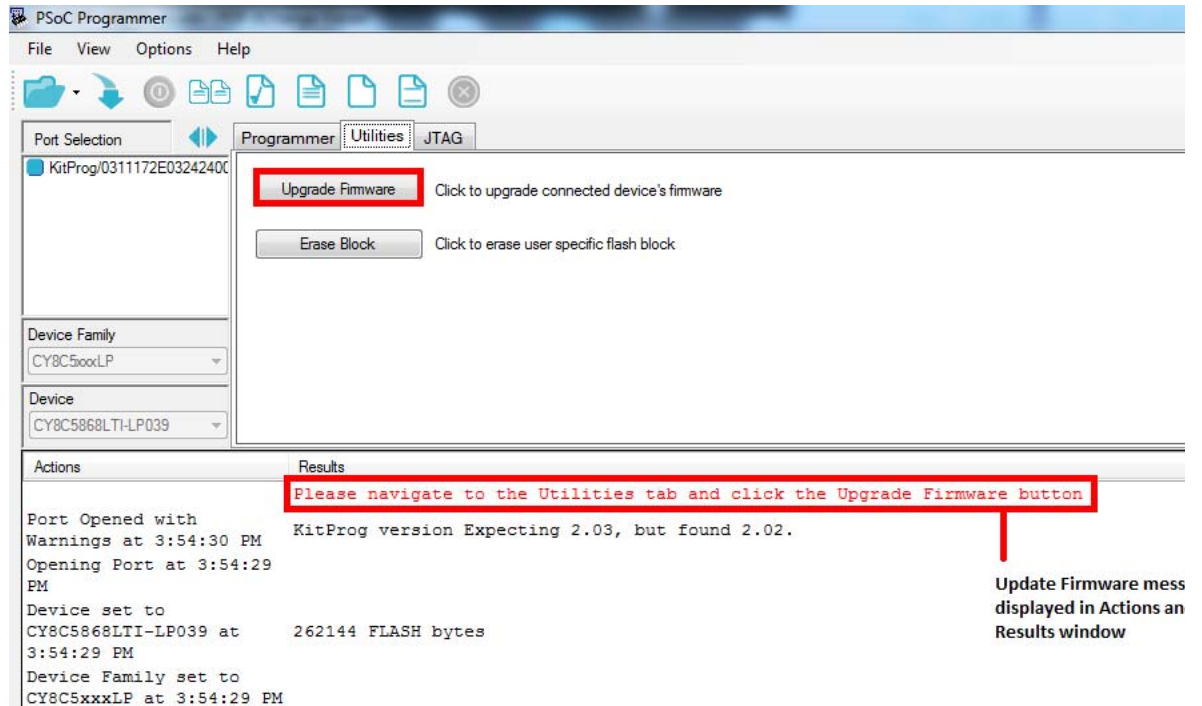

Update Firmware mess displayed in Actions an Results window

Click the **Utilities** tab and click the **Upgrade Firmware** button. On successful upgrade, the **Action and Results** window displays the firmware update message with the KitProg version.

Figure 3-14. Firmware Updated in PSoC Programmer

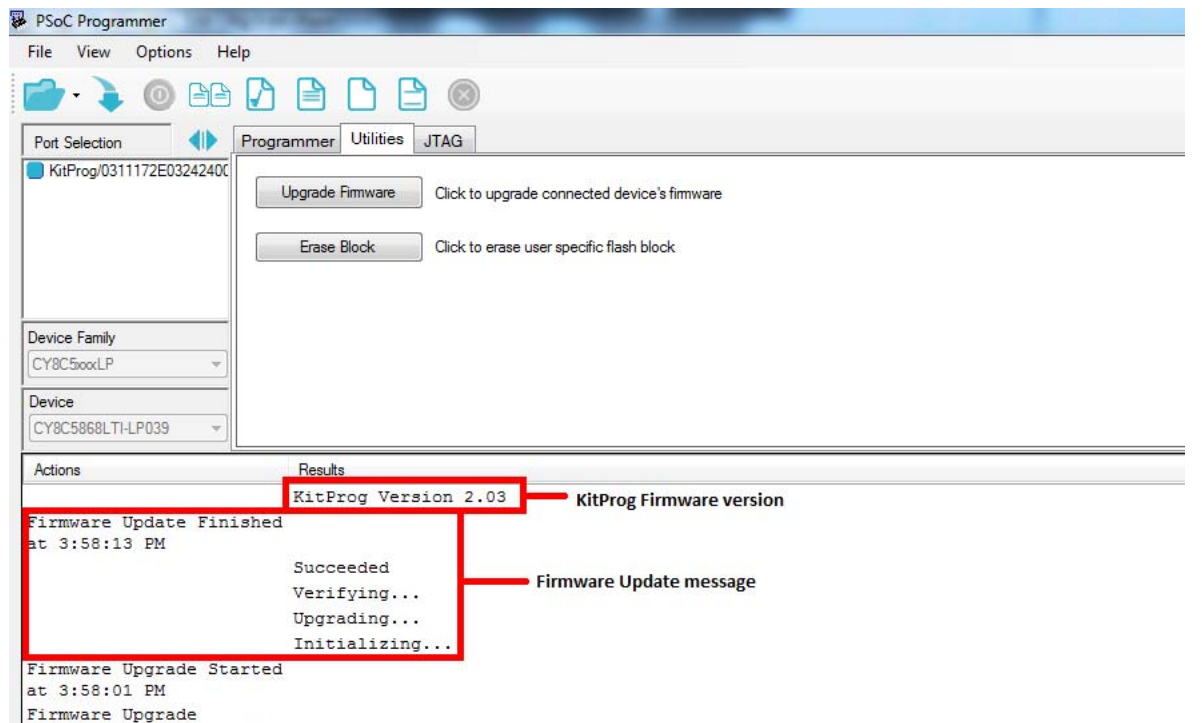

KitProg Firmware version

Firmware Update message

# 4. Hardware



## 4.1 Board Details

The PSoC 4 Pioneer Kit consists of the following blocks:

- PSoC 4
- PSoC 5LP
- Power supply system
- Programming interfaces (J6, J7 - unpopulated, J10)
- Arduino compatible headers (J1, J2, J3, J4, and J12 - unpopulated)
- Digilent Pmod compatible header (J5 - unpopulated)
- PSoC 5LP GPIO header (J8)
- CapSense slider
- Pioneer board LEDs
- Push buttons (Reset and User buttons)

Figure 4-1. PSoC 4 Pioneer Kit Details

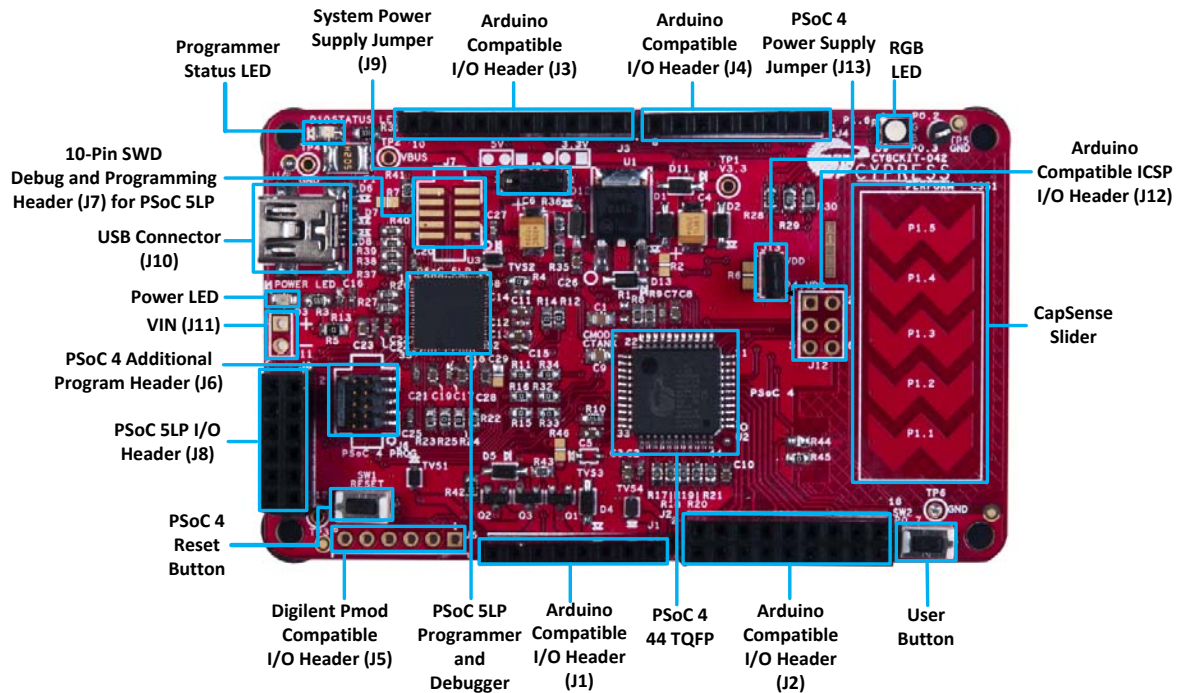
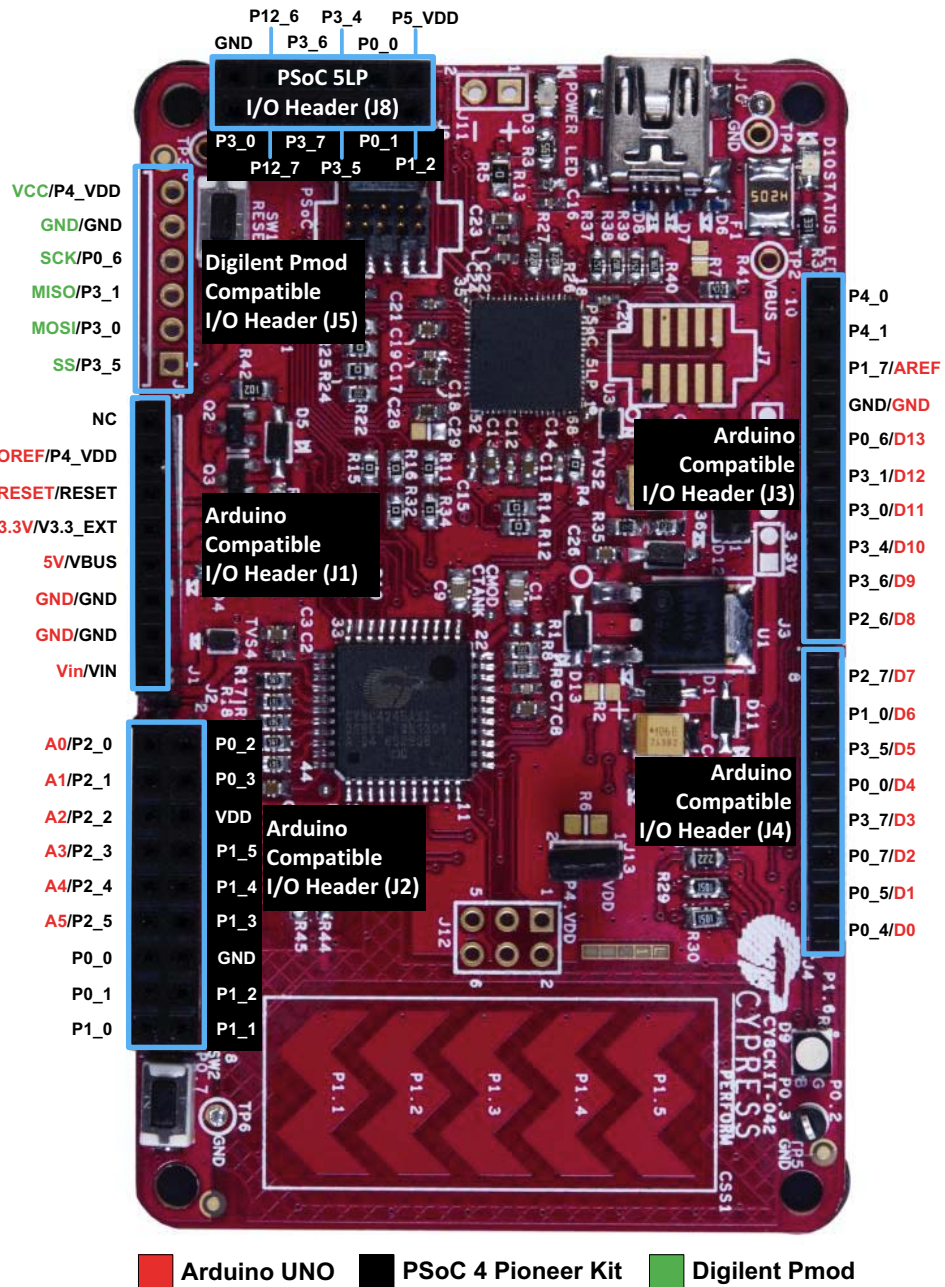

Figure 4-2. PSoC 4 Pioneer Kit Pin Mapping





## 4.2 Theory of Operation

This section provides the block-level description of the PSoC 4 Pioneer Kit.

Figure 4-3. Block Diagram

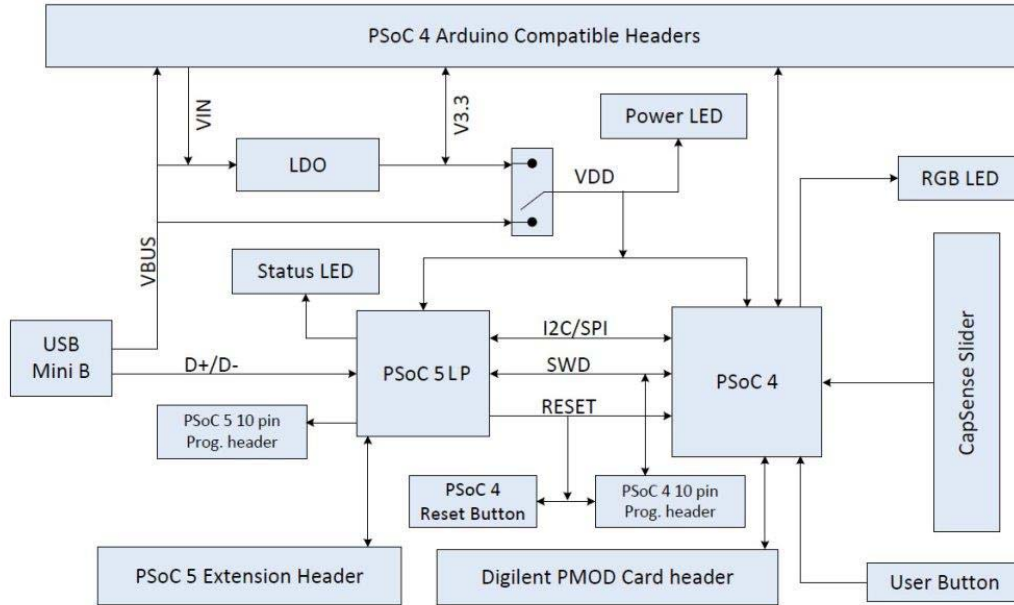

The PSoC 4 is a new generation of programmable system-on-chip devices from Cypress for embedded applications. It combines programmable analog, programmable digital logic, programmable I/O, and a high-performance ARM Cortex-M0 subsystem. With the PSoC 4, you can create the combination of peripherals required to meet the application specifications.

The PSoC 4 Pioneer Kit features an onboard PSoC 5LP, which communicates through the USB to program and debug the PSoC 4 using serial wire debug (SWD). The PSoC 5LP also functions as a USB-I2C bridge and USB-UART bridge.

The Pioneer Kit has an RGB LED, a status LED, and a power LED. The RGB LED is connected to the PSoC 4 and the status LED is connected to the PSoC 5LP. For more information on the status LED, see section [A.5 Error in Firmware/Status Indication in Status LED on page 120](#). This kit also includes a reset button that connects to the PSoC 4 XRES, a user button, and a five-segment CapSense slider, which can be used to develop touch-based applications. The PSoC 4 pins are brought out onto headers J1 to J4 on the kit to support Arduino shields. The PSoC 5LP pins are brought out onto header J8 to enable using the onboard PSoC 5LP to develop custom applications.

The PSoC 4 Pioneer Kit can be powered from the USB Mini B, the Arduino compatible header, or an external power supply. The input voltage is regulated by a low drop-out (LDO) regulator to 3.3 V. You can select between VBUS (5 V) and 3.3 V by suitably plugging the jumper onto the voltage selection header VDD.

## 4.3 Functional Description

### 4.3.1 PSoC 4

This kit uses the PSoC 4200 family device. PSoC 4200 devices are a combination of a microcontroller with programmable logic, high-performance analog-to-digital conversion, two opamps with comparator mode, and commonly used fixed-function peripherals. For more information, refer to the PSoC 4 [web page](#) and the [PSoC 4200 family datasheet](#).

#### Features

- 32-bit MCU subsystem
  - 48 MHz ARM Cortex-M0 CPU with single cycle multiply
  - Up to 32 KB of flash with read accelerator
  - Up to 4 KB of SRAM
- Programmable analog
  - Two opamps with reconfigurable high-drive external and high-bandwidth internal drive, comparator modes, and ADC input buffering capability
  - 12-bit 1-Msps SAR ADC with differential and single-ended modes; channel sequencer with signal averaging
  - Two current DACs (IDACs) for general-purpose or capacitive sensing applications on any pin
  - Two low-power comparators that operate in deep sleep
- Programmable digital
  - Four programmable logic blocks called universal digital blocks (UDBs), each with eight Macro-cells and data path
  - Cypress-provided peripheral component library, user-defined state machines, and Verilog input
- Low power 1.71 to 5.5 V operation
  - 20-nA Stop mode with GPIO pin wakeup
  - Hibernate and Deep-Sleep modes allow wakeup-time versus power trade-offs
- Capacitive sensing
  - Cypress Capacitive Sigma-Delta (CSD) provides best-in-class SNR (greater than 5:1) and water tolerance
  - Cypress-supplied software component makes capacitive sensing design easy
  - Automatic hardware tuning (SmartSense™)
- Segment LCD drive
  - LCD drive supported on all pins (common or segment)
  - Operates in Deep-Sleep mode with 4 bits per pin memory
- Serial communication
  - Two independent run-time reconfigurable serial communication blocks (SCBs) with re-configurable I2C, SPI, or UART functionality
- Timing and pulse-width modulation
  - Four 16-bit Timer/Counter Pulse-Width Modulator (TCPWM) blocks
  - Center-aligned, Edge, and Pseudo-random modes
  - Comparator-based triggering of Kill signals for motor drive and other high-reliability digital logic applications
- Up to 36 programmable GPIOs
  - 44-pin TQFP, 40-pin QFN, and 28-pin SSOP packages
  - Any GPIO pin can be CapSense, LCD, analog, or digital
  - Drive modes, strengths, and slew rates are programmable
- PSoC Creator design environment
  - Integrated development environment (IDE) provides schematic design entry and build (with analog and digital automatic routing)

- Applications Programming Interface (API) component for all fixed-function and programmable peripherals
- Industry-standard tool compatibility
  - After schematic entry, development can be done with ARM-based industry-standard development tools

For more information see the [CY8C42 family datasheet](#).

### 4.3.2 PSoC 5LP

An onboard PSoC 5LP is used to program and debug PSoC 4. The PSoC 5LP connects to the USB port of the PC through a USB Mini B connector and to the SWD interface of the PSoC 4 device.

PSoC 5LP is a true system-level solution providing MCU, memory, analog, and digital peripheral functions in a single chip. The CY8C58LPxx family offers a modern method of signal acquisition, signal processing, and control with high accuracy, high bandwidth, and high flexibility. Analog capability spans the range from thermocouples (near DC voltages) to ultrasonic signals. For more information, refer to the PSoC 5LP [web page](#).

#### Features

- 32-bit ARM Cortex-M3 CPU core
  - DC to 67-MHz operation
  - Flash program memory, up to 256 KB, 100,000 write cycles, 20-year retention, and multiple security features
  - Up to 32-KB flash error correcting code (ECC) or configuration storage
  - Up to 64 KB SRAM
  - 2-KB electrically erasable programmable read-only memory (EEPROM) memory, 1 M cycles, and 20 years retention
  - 24-channel direct memory access (DMA) with multilayer AHB bus access
    - a. Programmable chained descriptors and priorities
    - b. High bandwidth 32-bit transfer support
- Low voltage, ultra low power
  - Wide operating voltage range: 0.5 V to 5.5 V
  - High-efficiency boost regulator from 0.5 V input to 1.8 V to 5.0 V output
  - 3.1 mA at 6 MHz
  - Low power modes including:
    - a. 2- $\mu$ A sleep mode with real time clock (RTC) and low-voltage detect (LVD) interrupt
    - b. 300-nA hibernate mode with RAM retention
- Versatile I/O system
  - 28 to 72 I/Os (62 GPIOs, 8 SIOs, 2 USBIOs)
  - Any GPIO to any digital or analog peripheral routability
  - LCD direct drive from any GPIO, up to 46 $\times$ 16 segments
  - CapSense support from any GPIO[3]
  - 1.2 V to 5.5 V I/O interface voltages, up to 4 domains
  - Maskable, independent IRQ on any pin or port
  - Schmitt-trigger transistor-transistor logic (TTL) inputs
  - All GPIOs configurable as open drain high/low, pull-up/pull-down, High-Z, or strong output
  - Configurable GPIO pin state at power-on reset (POR)
  - 25 mA sink on SIO
- Digital peripherals
  - 20 to 24 programmable logic device (PLD) based universal digital blocks (UDBs)
  - Full CAN 2.0b 16 RX, 8 TX buffers
  - Full-Speed (FS) USB 2.0 12 Mbps using internal oscillator

- Four 16-bit configurable timers, counters, and PWM blocks
- 67-MHz, 24-bit fixed point digital filter block (DFB) to implement finite impulse response (FIR) and infinite impulse response (IIR) filters
- Library of standard peripherals
  - a. 8-, 16-, 24-, and 32-bit timers, counters, and PWMs
  - b. Serial peripheral interface (SPI), universal asynchronous transmitter receiver (UART), and I2C
  - c. Many others available in catalog
- Library of advanced peripherals
  - a. Cyclic redundancy check (CRC)
  - b. Pseudo random sequence (PRS) generator
  - c. Local interconnect network (LIN) bus 2.0
  - d. Quadrature decoder
- Analog peripherals ( $1.71\text{ V} \leq V_{DDA} \leq 5.5\text{ V}$ )
- $1.024\text{ V} \pm 0.1\%$  internal voltage reference across  $-40\text{ }^{\circ}\text{C}$  to  $+85\text{ }^{\circ}\text{C}$
- Configurable delta-sigma ADC with 8- to 20-bit resolution
- Sample rates up to 192 ksp/s
- Programmable gain stage:  $\times 0.25$  to  $\times 16$
- 12-bit mode, 192 ksp/s, 66-dB signal to noise and distortion ratio (SINAD),  $\pm 1$ -bit INL/DNL
- 16-bit mode, 48 ksp/s, 84-dB SINAD,  $\pm 2$ -bit INL,  $\pm 1$ -bit DNL
- Up to two SAR ADCs, each 12-bit at 1 Msp/s
- Four 8-bit 8 Msp/s current IDACs or 1-Msp/s voltage VDACS
- Four comparators with 95-ns response time
- Four uncommitted opamps with 25-mA drive capability
- Four configurable multifunction analog blocks. Example configurations are programmable gain amplifier (PGA), transimpedance amplifier (TIA), mixer, and sample and hold
- CapSense support
- Programming, debug, and trace
  - JTAG (4 wire), SWD (2 wire), single wire viewer (SWV), and TRACEPORT interfaces
  - Cortex-M3 flash patch and breakpoint (FPB) block
  - Cortex-M3 Embedded Trace Macrocell™ (ETM™) generates an instruction trace stream
  - Cortex-M3 data watchpoint and trace (DWT) generates data trace information
  - Cortex-M3 Instrumentation Trace Macrocell (ITM) can be used for printf-style debugging
  - DWT, ETM, and ITM blocks communicate with off-chip debug and trace systems via the SWV or TRACEPORT
  - Bootloader programming supportable through I2C, SPI, UART, USB, and other interfaces
- Precision, programmable clocking
  - 3- to 62-MHz internal oscillator over full temperature and voltage range
  - 4- to 25-MHz crystal oscillator for crystal PPM accuracy
  - Internal PLL clock generation up to 67 MHz
  - 32.768-kHz watch crystal oscillator
  - Low-power internal oscillator at 1, 33, and 100 kHz

For more, see the [CY8C58LPxx family datasheet](#).

### 4.3.3 Power Supply System

The power supply system on this board is versatile, allowing the input supply to come from the following sources:

- 5-V power from onboard USB programming header J10
- 5-V to 12-V power from Arduino shield using J1\_01 header
- VTARG - power from the onboard SWD programming using J6 or J7
- VIN - J11

The PSoC 4 and PSoC 5LP are powered with either a 3.3 V or 5 V source. The selection between 3.3 V and 5 V is made through the J9 jumper. The board can supply 3.3 V and 5 V to the I/O headers and receive 3.3 V from the I/O headers. The board can also be powered with an external power supply through the VIN (J11) header; the allowed voltage range for the VIN is 5 V to 12 V. The LDO regulator regulates the VIN down to 3.3 V. Figure 4-4 shows the power supply block diagram and protection circuitry.

**Note:** The 5-V domain is directly powered by the USB (VBUS). For this reason, this domain is unregulated.

Figure 4-4. Power Supply Block Diagram with Protection Circuits

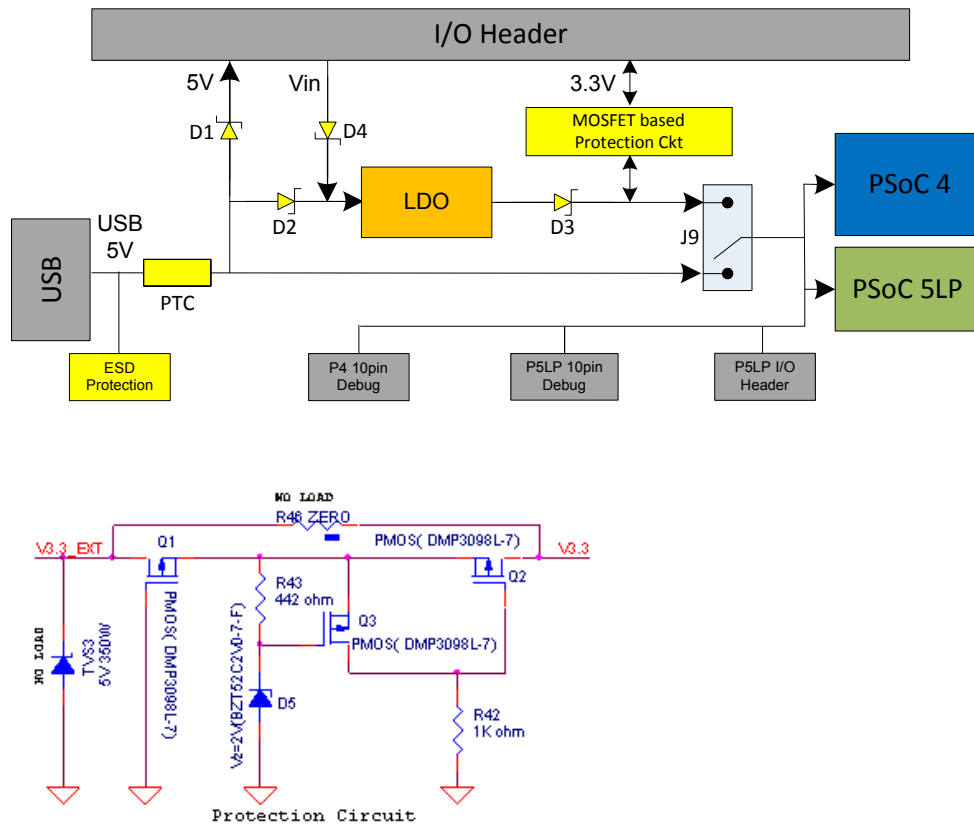

#### 4.3.3.1 Protection Circuit

The power supply rail has reverse-voltage, over-voltage, short circuits, and excess current protection features, as seen in [Figure 4-4](#).

- The Schottky diode (D1) ensures power cannot be supplied to the 5-V domain of the board from the I/O header.
- The series protection diode (D2) ensures VIN (power supply from the I/O header) does not back power the USB.
- The Schottky diode (D3) ensures 3.3 V from I/O header does not back power the LDO.
- The series protection diode (D4) ensures that the reverse-voltage cannot be supplied from the VIN to the regulator input.
- A PTC resettable fuse is connected to protect the computer's USB ports from shorts and over-current.
- The MOSFET-based protection circuit provides over-voltage and reverse-voltage protection to the 3.3-V rail. The PMOS Q1 protects the board components from a reverse-voltage condition. The PMOS Q2 protects the PSoC from an over-voltage condition. The PMOS Q2 will turn off when a voltage greater than 4.2 V is applied, protecting the PSoC 4.
- The output voltage of the LDO is adjusted such that it takes into account the voltage drop across the Schottky diode and provides 3.3 V.

#### 4.3.3.2 Procedure to Measure PSoC 4 Current Consumption

The following three methods are supported for measuring current consumption of the PSoC 4 device.

- When the board is powered through the USB port (J10), remove jumper J13 and connect an ammeter, as shown in [Figure 4-5](#).

Figure 4-5. PSoC 4 Current Measurement when Powered from USB Port



- When using a separate power supply for the PSoC 4 with USB powering (regulator output on the USB supply must be within 0.5 V of the separate power supply).
  - Remove jumper J13. Connect the positive terminal of voltage supply to the positive terminal of the ammeter and the negative terminal of the ammeter to the lower pin of J13. [Figure 4-6](#) shows the required connections.

Figure 4-6. PSoC 4 Current Measurement when Powered Separately



- When the PSoC 4 is powered separately and the PSoC 5LP is not powered, make these changes to avoid leakage while measuring current:
  - Remove the zero-ohm resistors R24 and R25. Removing these resistors will affect the USB-I2C functionality.
  - Remove R11, R15, and R16, which are meant for programming the PSoC 4. Removing these resistors disables the PSoC 5LP capability for programming.
  - Connect an ammeter between pins 1 and 2 of header J13 to measure current.

Figure 4-7. Zero-ohm Resistor Position

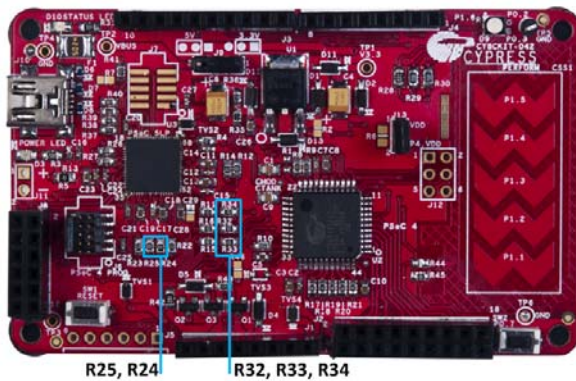

#### 4.3.4 Programming Interface

The kit allows programming and debugging of the PSoC 4 in two modes:

- [Using the Onboard PSoC 5LP Programmer and Debugger](#)
- [Using CY8CKIT-002 MiniProg3 Programmer and Debugger](#)

#### 4.3.5 Arduino Compatible Headers (J1, J2, J3, J4, and J12 - unpopulated)

This kit has five Arduino compatible headers; J1, J2, J3, J4 and J12. You can develop applications based on the Arduino shield's hardware.

Figure 4-8. Arduino Header

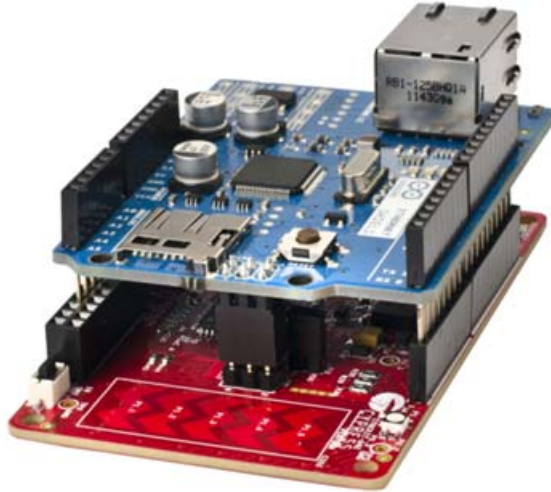

The J1 header contains I/O pins for reset, internal reference voltage (IOREF), and power supply line. The J2 header is an analog port. It contains I/O pins for SAR ADC, comparator, and opamp. The J3 header is primarily a digital port. It contains I/O pins for PWM, I2C, SPI, and analog reference. The J4 header is also a digital port. It contains I/O pins for UART and PWM. The J12 header is an Arduino ICSP compatible header for the SPI interface. This header is not populated. Refer to the “No Load Components” section of [A.6 Bill of Materials \(BOM\) on page 121](#) for the header part number.

**Note:** The PSoC 4 pin P0[0] is connected to both pin 13 of the J2 header and pin 5 of the J4 header. Similarly, the PSoC 4 pin P1[0] is connected to both pin 17 of the J2 header and pin 7 of the J4 header. Therefore, when using P0[0] or P1[0] from either the J2 or J4 header, there should not be any external signal connected to the other header.



Figure 4-9. Arduino Compatible Headers

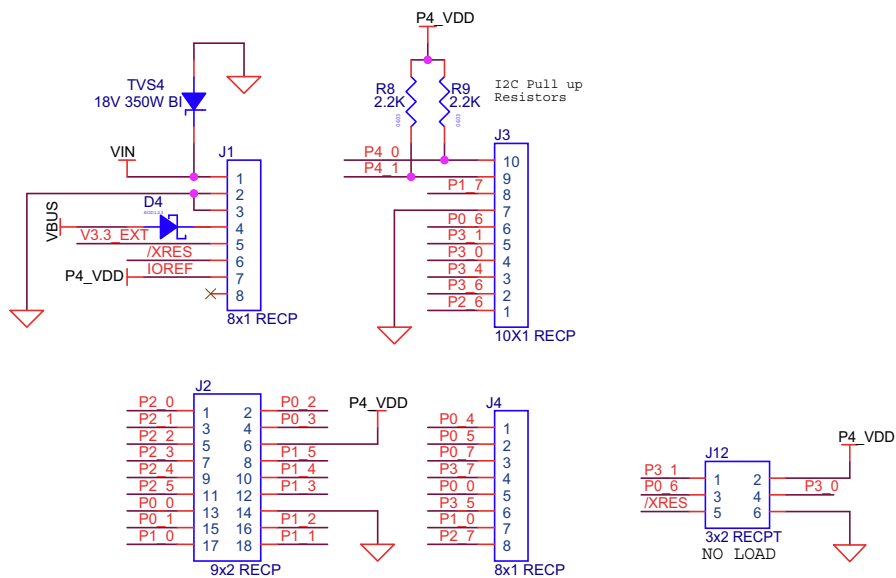
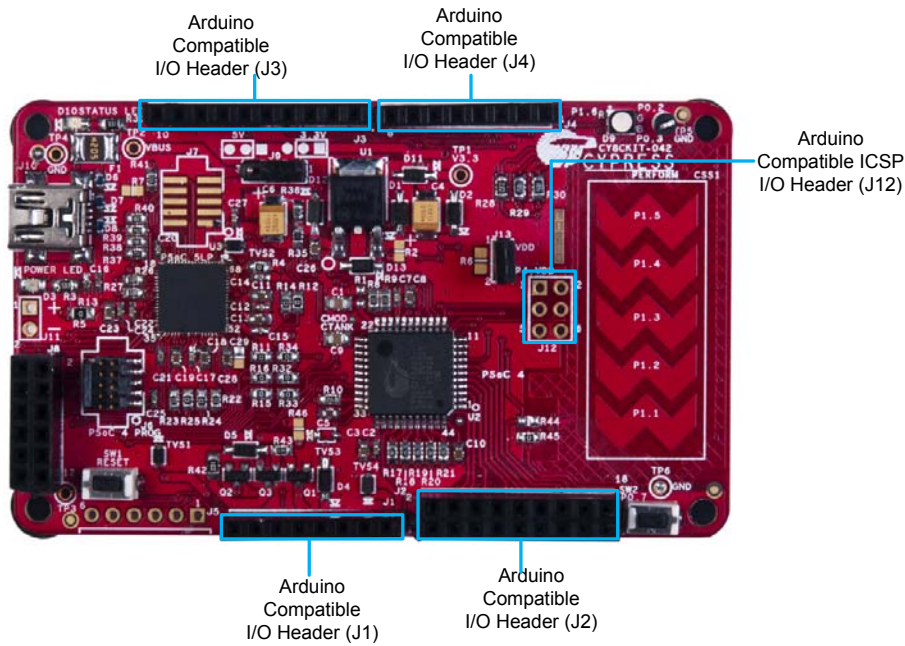

(J1-J4) Arduino Compatible Headers

#### 4.3.5.1 Additional Functionality of Header J2

The J2 header is a 9×2 header that supports Arduino shields. The port 0, port 1, and port 2 pins of PSoC 4 are brought to this header. The port 1 pins additionally connect to the onboard CapSense slider through 560-Ω resistors. When the CapSense feature is not used, remove these resistors to ensure a better performance with these pins.

#### 4.3.5.2 *Functionality of Unpopulated Header J12*

The J12 header is a 2×3 header that supports Arduino shields. This header is used on a small subset of shields and is unpopulated on the PSoC 4 Pioneer Kit. Note that the J12 header only functions in 5.0 V mode. To ensure proper shield functionality, ensure the power jumper is connected in 5.0 V mode.

#### 4.3.6 Digilent Pmod Compatible Header (J5 - unpopulated)

This port supports Digilent Pmod peripheral modules. Pmods are small I/O interfaces, which connect with the embedded control boards through either 6- or 12-pin connectors. The PSoC Pioneer Kit supports the 6-pin Pmod type 2 (SPI) interface. For Digilent Pmod cards, go to [www.digilentinc.com](http://www.digilentinc.com).

This header is not populated on the PSoC 4 Pioneer Kit. You must populate this header before connecting the Pmod daughter cards. Refer to the “No Load Components” section of [A.6 Bill of Materials \(BOM\) on page 121](#) for the header part number.

Figure 4-10. Pmod Connection



Figure 4-11. Digilent Pmod Interface

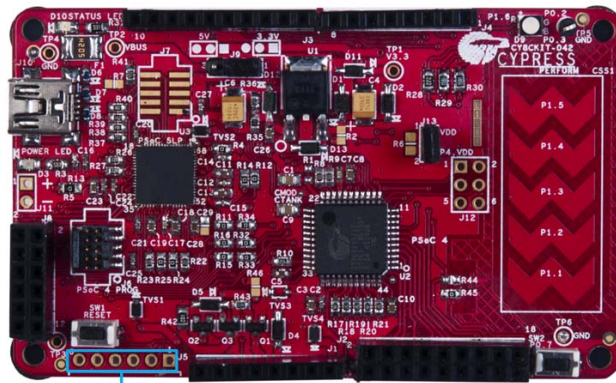

Digilent® Pmod™ Compatible I/O Header (J5)

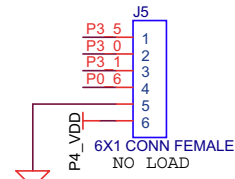

J5 Digilent Pmod Cards Compatible Headers

See [A.2 Pin Assignment Table on page 116](#) for details on the pin descriptions for the J5 header.

### 4.3.7 PSoc 5LP GPIO Header (J8)

A limited set of PSoc 5LP pins are brought to this header. Refer to [6.3 Developing Applications for PSoc 5LP on page 88](#) for details on how to develop custom applications. See [A.2 Pin Assignment Table on page 116](#) for pin details.

Figure 4-12. PSoc 5LP GPIO Header (J8)

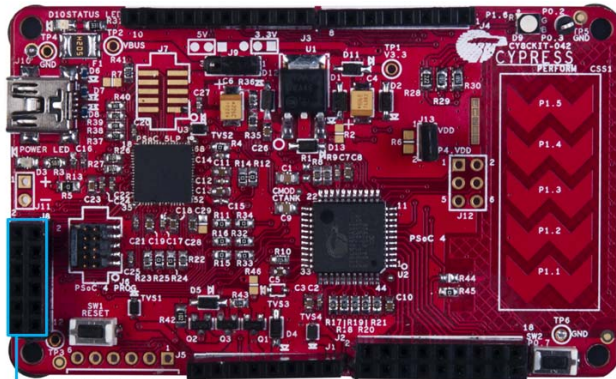

PSoc 5LP I/O Header (J8)

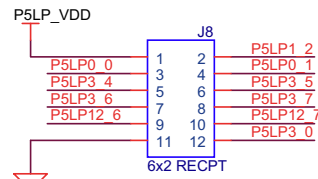

PSoc 5LP GPIO Extension Header

### 4.3.8 CapSense Slider

The kit has a five-segment linear capacitive touch slider on the board, which is connected to pins P1[1] to P1[5] of the PSoc 4 device.

The modulation capacitor (Cmod) is connected to pin P4[2] and an optional bleeder resistor (R1) can be connected across the Cmod. This board supports CapSense designs that enable waterproofing.

The waterproofing design uses a concept called shield, which is a conductor placed around the sensors. This shield must be connected to a designated shield pin on the device to function. The shield must be connected to the ground when not used. On the PSoc 4 Pioneer Kit, the connection of the shield to the pin or to the ground is made by resistors R44 and R45, respectively. By default, R45 is mounted on the board, which connects the shield to the ground. Populate R44 when evaluating waterproofing designs, which will connect the shield to the designated pin, P0[1]. This shield is different from the Arduino shields, which are boards that connect over the Arduino header. Refer to the [CapSense Design Guide](#) for further details related to CapSense.

Figure 4-13. CapSense Slider

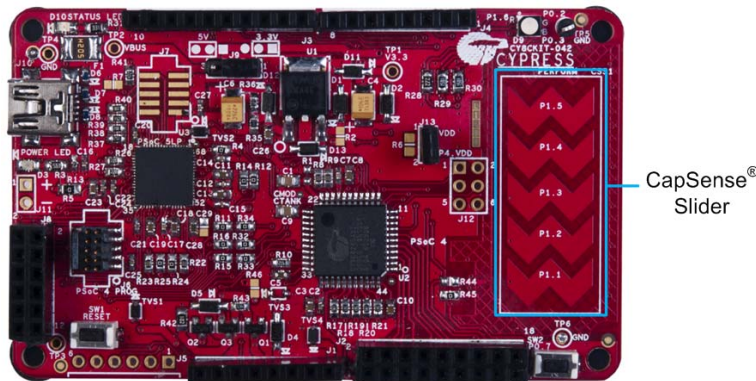
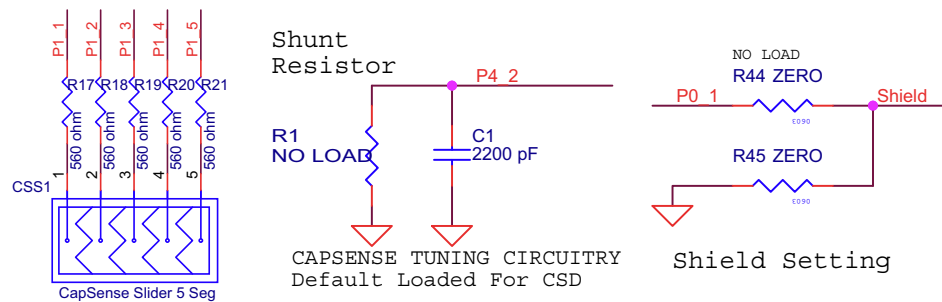

Figure 4-14. CapSense Slider Connection



### 4.3.9 Pioneer Board LEDs

The PSoC 4 Pioneer board has three LEDs. A green LED (D10) indicates the status of the programmer. See [A.5 Error in Firmware/Status Indication in Status LED](#) for a detailed list of LED indications. An amber LED (D3) indicates status of power supplied to the board. The kit also has a general-purpose tricolor LED (D9) for user applications that connect to specific PSoC 4 pins.

Figure 4-15 shows the indication of all these LEDs on the board. Figure 4-16 and Figure 4-17 detail the LED schematic.

Figure 4-15. Pioneer Kit LEDs

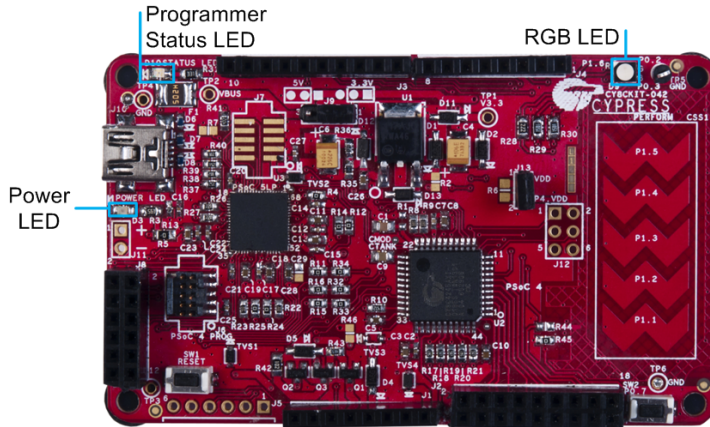
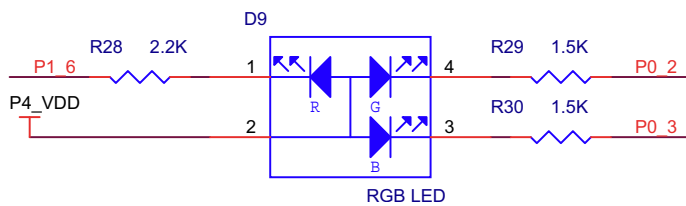

Figure 4-16. Status LED and Power LED



Figure 4-17. RGB LED



### 4.3.10 Push Buttons

The kit contains a Reset push button and a User push button, as shown in [Figure 4-18](#).

The Reset button is connected to the XRES pin of PSoC 4 and is used to reset the onboard PSoC 4 device. The User button is connected to P0[7] of PSoC 4 device. Both the push buttons connect to ground on activation (active low).

Figure 4-18. Push Buttons

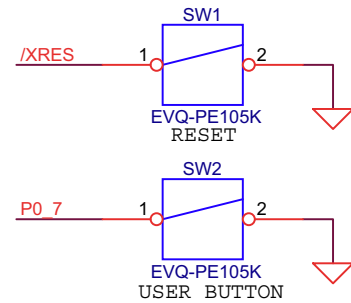
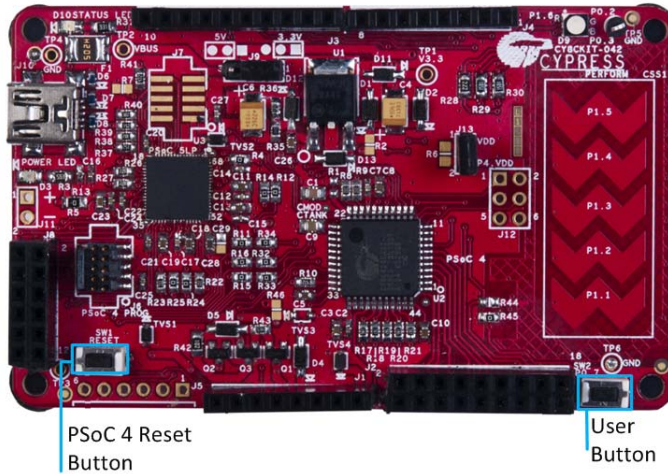

# 5. Code Examples



The code examples described in this chapter introduce the functionality of the PSoC 4 device and the onboard components. To access the examples, download the CD ISO image or setup files from the kit [web page](#). The code examples will be available in the firmware folder in the install location. For a list of all code examples available with PSoC Creator visit [PSoC 3/4/5 Code Examples webpage](#).

Follow these steps to open and program code examples:

1. Launch PSoC Creator from the Start menu.
2. Open the code example by clicking **<Project.cywrk>** below **Examples and Kits > Find Example Project > Kits > CY8CKIT-042**.

Figure 5-1. Open Code Example from PSoC Creator

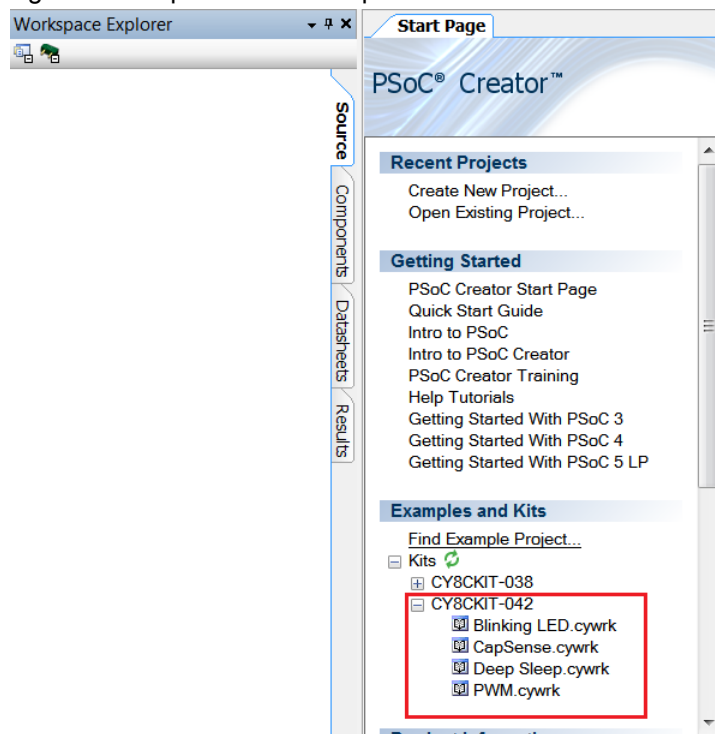

- Build the code example by clicking **Build > Build <Project name>** to generate the hex file.

Figure 5-2. Build Project from PSoC Creator

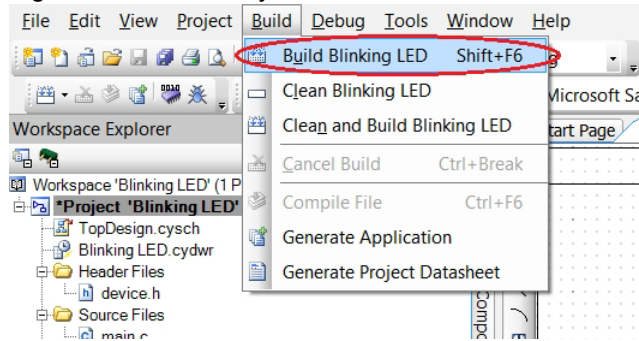

- To program, connect the board to a computer using the USB cable connected to port J10, as described in section 3.2 Programming and Debugging PSoC 4 on page 23. The board is detected as **KitProg**.
- Click **Debug > Program** from PSoC Creator.

Figure 5-3. Program Device from PSoC Creator

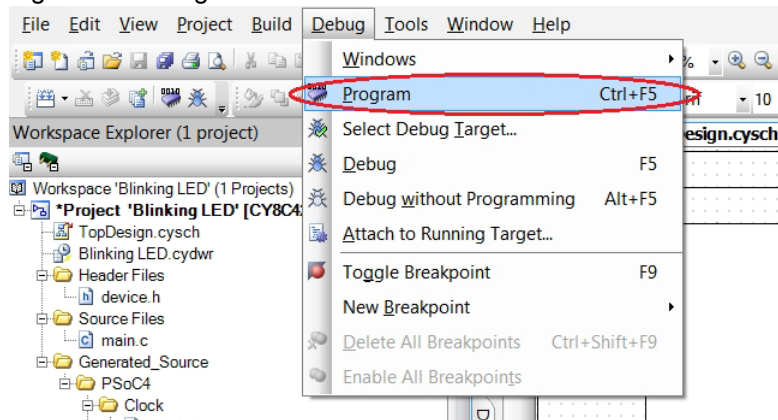

- If the device is not yet acquired, PSoC Creator will open the programming window. Select **KitProg/** and click the **Port Acquire** button.

Figure 5-4. Acquire Device from PSoC Creator

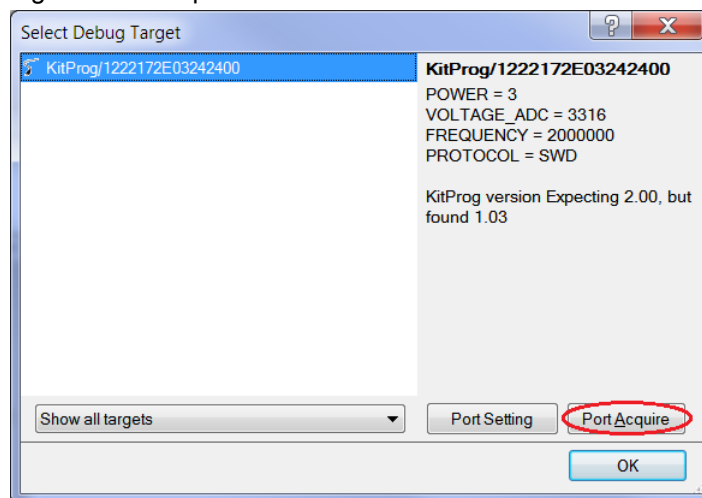



7. After the device is acquired, it is shown in a tree structure below the **KitProg**. Now, click the **Connect** button.

Figure 5-5. Connect Device from PSoC Creator

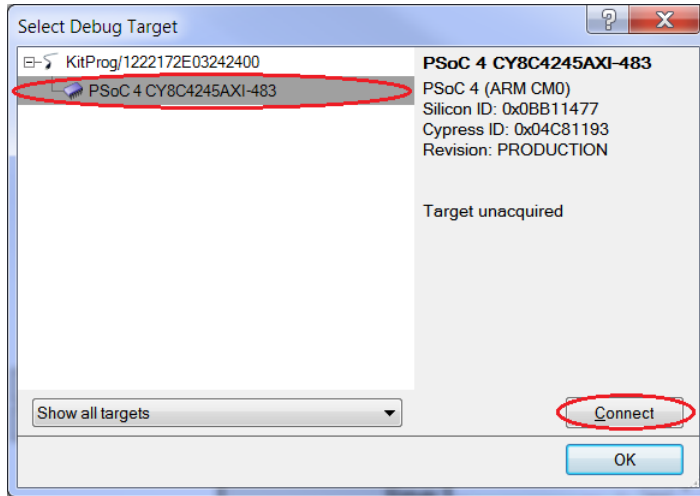

8. Click **OK** to exit the window and start programming.

Figure 5-6. Program Device from PSoC Creator

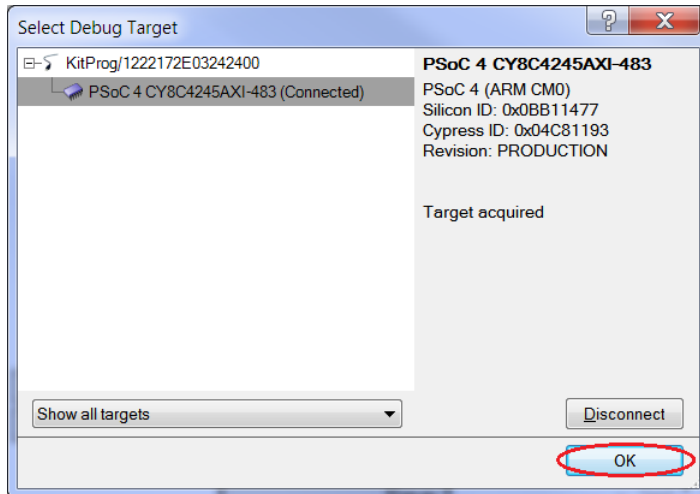

## 5.1 Project: Blinking LED

### 5.1.1 Project Description

This example uses a pulse-width modulator (PWM) to illuminate the RGB LED. The PWM output is connected to pin P0\_3 (blue) of the RGB LED. The frequency of blinking is set to 1 Hz with a duty cycle of 50 percent. The blinking frequency and duty cycle can be varied by varying the period and compare value respectively.

**Note:** The PSoC 4 Pioneer Kit is factory-programmed with this example.

Figure 5-7. PSoC Creator Schematic Design of Blinking LED Project

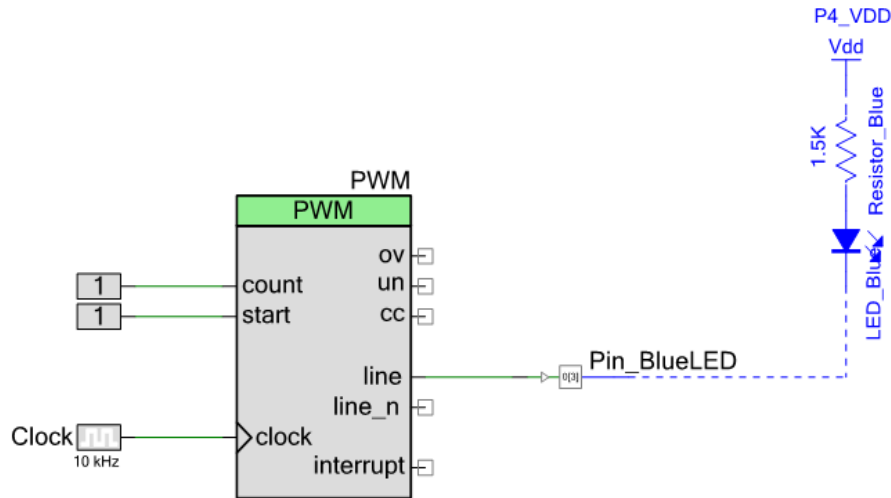

### 5.1.2 Hardware Connections

No specific hardware connections are required for this project because all connections are hard-wired on the board. Open *Blinking LED.cydwr* in the Workspace Explorer and select the suitable pin.

Table 5-1. Pin Connection

Pin Name	Port Name
Pin_BlueLED	P0_3 (Blue)

Figure 5-8. Pin Selection for Blinking LED Project

Alias	Name	Port	Pin	Lock
	Pin_BlueLED	P0 [3] COMP2:inn	27	<input checked="" type="checkbox"/>

### 5.1.3 Flow Chart

Figure 5-9 shows the flow chart of code implemented in *main.c*.

Figure 5-9. Blinking LED Project Flow Chart

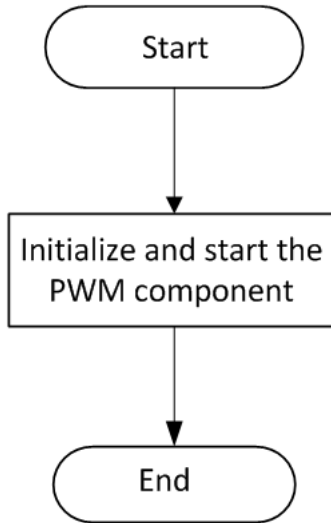

### 5.1.4 Verify Output

Build and program the code example onto the device. Observe the frequency and duty cycle of the blinking LED. Change the period and compare value in the PWM component, as shown in Figure 5-10. Rebuild and reprogram the device to vary the frequency and duty cycle.

Figure 5-10. PWM Component Configuration Window

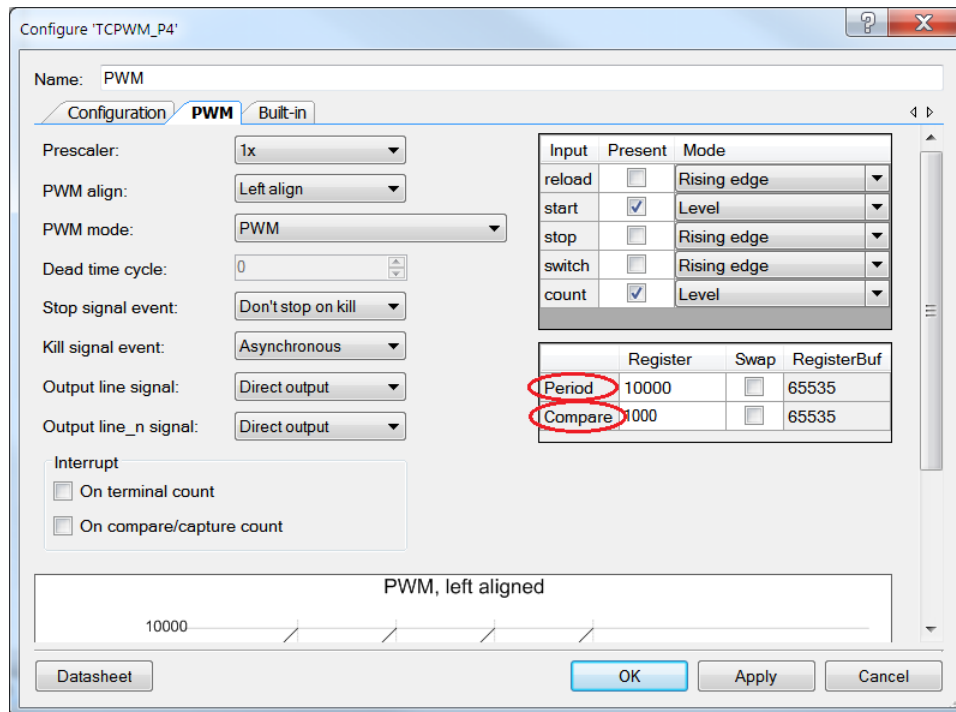

## 5.2 Project: PWM

### 5.2.1 Project Description

This code example demonstrates the use of the PWM component. The project uses three PWM outputs to set the color of RGB LED on the Pioneer Kit. The LED cycles through seven colors – violet > indigo > blue > green > yellow > orange > red (VIBGYOR). Each color is maintained for a duration of one second. The different colors are achieved by changing the pulse width of the PWMs.

Figure 5-11. PSoC Creator Schematic Design of PWM Project

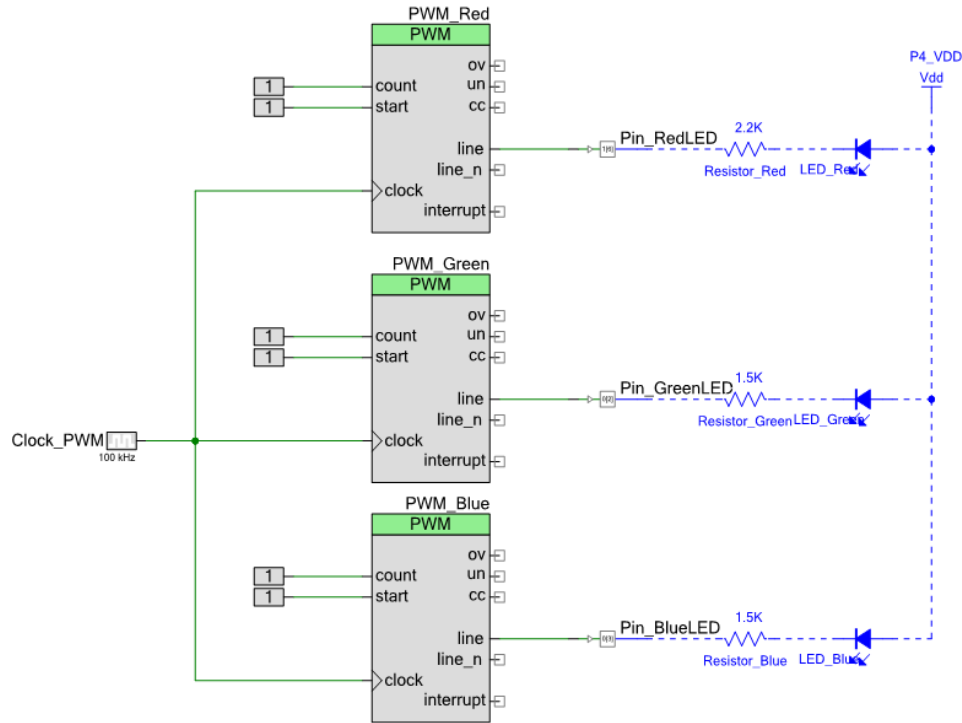

### 5.2.2 Hardware Connections

No specific hardware connections are required for this project because all connections are hard-wired on the board. Open *PWM.cydwr* in the Workspace Explorer and select the suitable pins.

Table 5-2. Pin Connections

Pin Name	Port Name
Pin_RedLED	P1_6 (Red)
Pin_GreenLED	P0_2 (Green)
Pin_BlueLED	P0_3 (Blue)

Figure 5-12. Pin Selection for PWM Project

Alias	Name	Port	Pin	Lock
Pin_BlueLED	P0[3] COMP2:inn		27	<input checked="" type="checkbox"/>
Pin_GreenLED	P0[2] COMP2:inp, SCB0:spi_ssel[3]		26	<input checked="" type="checkbox"/>
Pin_RedLED	P1[6] OA0:vplus alt		43	<input checked="" type="checkbox"/>

### 5.2.3 Flow Chart

Figure 5-13 shows the flow chart of code implemented in *main.c*.

Figure 5-13. PWM Project Flow Chart

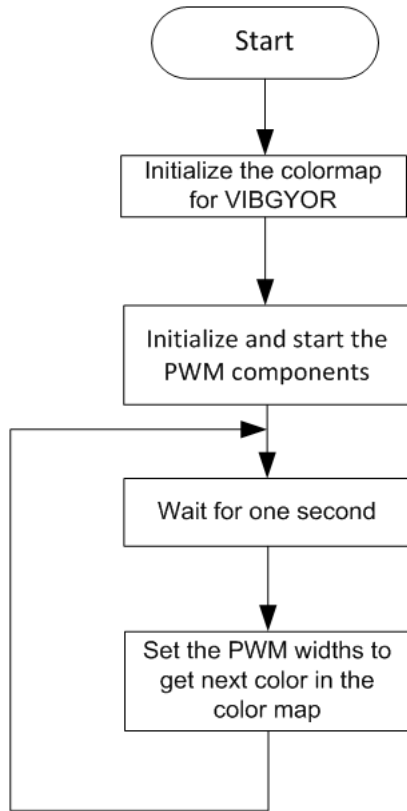

### 5.2.4 Verify Output

Build and program the code example, and reset the device. Observe the RGB LED cycles through the color pattern.

## 5.3 Project: Deep Sleep

### 5.3.1 Project Description

This project demonstrates the low-power functionality of the PSoC 4. The LED is turned on for one second to indicate Active mode; then, the device enters Deep-Sleep mode. When switch SW2 is pressed, the device wakes up and the LED is turned on for one second and then goes back into Deep-Sleep mode.

Figure 5-14. PSoC Creator Schematic Design of Deep-Sleep Project

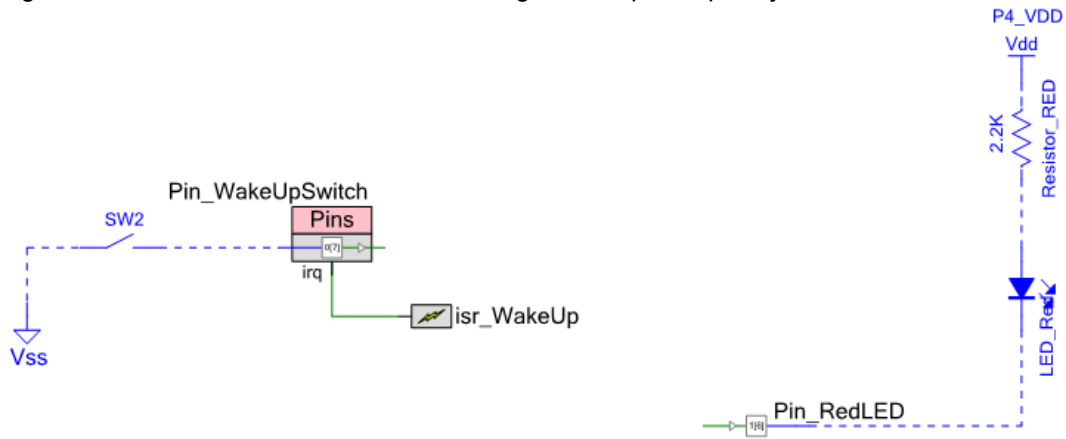

### 5.3.2 Hardware Connections

No extra connections are required for the project functionality because the connections are hard-wired onto the board. To make low-power measurements using this project, refer to the use case detailed in section 4.3.3.2 [Procedure to Measure PSoC 4 Current Consumption on page 38](#).

Open *Deep Sleep.cydwr* in the Workspace Explorer and select the suitable pin.

Table 5-3. Pin Connection

Pin Name	Port Name
Pin_RedLED	P1_6 (Red)
Pin_WakeUpSwitch	P0_7

Figure 5-15. Pin Selection for Deep-Sleep Project

Alias	Name	Port	Pin	Lock
Pin_RedLED	P1[6] OA0:vplus_alt		43	<input checked="" type="checkbox"/>
Pin_WakeUpSwitch	P0[7] SRSS:wakeup, SCB1:spi_ssel[0]		31	<input checked="" type="checkbox"/>

### 5.3.3 Flow Chart

Figure 5-16 shows the flow chart of code implemented in *main.c*.

Figure 5-16. Deep-Sleep Project Flow Chart

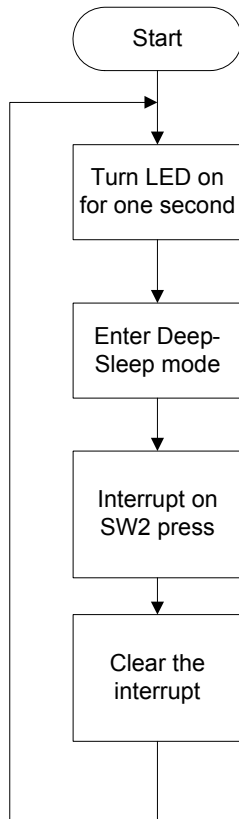

### 5.3.4 Verify Output

Build and program the code example, and reset the device. LED is on for one second and turns off, which indicates that the device has entered Deep-Sleep mode. Press SW2 switch to wake up the device from Deep-Sleep mode and enter Active mode. The device goes back to sleep after one second.

**Note:** When the device is in Deep-Sleep mode, the programmer must reacquire the device before programming can start.

## 5.4 Project: CapSense

This code example can be executed in two ways – with and without CapSense tuning. The same project can be used to demonstrate the CapSense functionality as well as CapSense tuning using the Tuner Helper GUI in PSoC Creator. This is done by commenting and uncommenting the line `#define ENABLE_TUNER` in the `main.c` file of the code example. PSoC Creator does not compile the code under the `#ifdef` (if defined) statement when the `#define` statement is commented (`/*..... */` or `//`). Similarly, when the `#define` statement is uncommented, the code required for working with Tuner GUI is compiled. By default, the project is set to work without CapSense tuning by commenting the `#define`.

### 5.4.1 CapSense (Without Tuning)

#### 5.4.1.1 Project Description

This code example demonstrates CapSense on PSoC 4. The example uses the five-segment CapSense slider on the board. Each capacitive sensor on the slider is scanned using Cypress’s CapSense Sigma Delta (CSD) algorithm implemented in the CapSense component. This project is pre-tuned to take care of the board parasitics. For more information on the CapSense component and CapSense tuning, see the CapSense component datasheet in PSoC Creator.

In this code example, the brightness of the green and red LEDs are varied, based on the position of the user’s finger on the CapSense slider.

Figure 5-17. PSoC Creator Schematic Design of CapSense Project

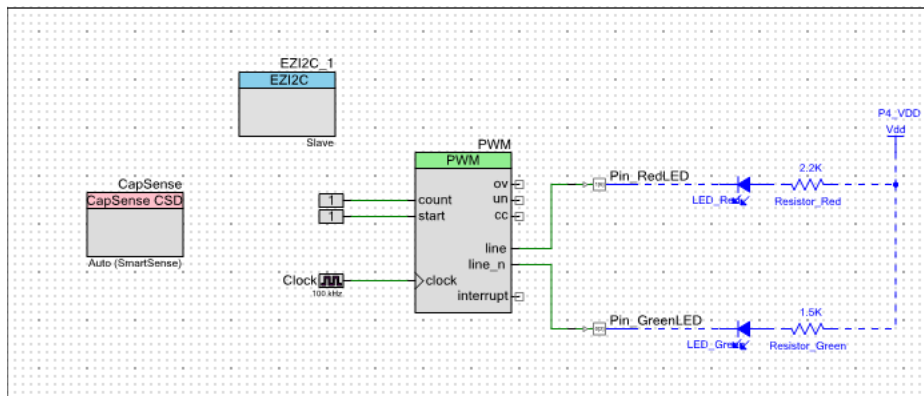

**Note:** The EzI2C component is not used when tuning is disabled.



### 5.4.1.2 Hardware Connections

No specific hardware connections are required for this project because all connections are hard-wired on the board. Open *CapSense.cydwr* in the Workspace Explorer and select the suitable pins.

Table 5-4. Pin Connection

Pin Name	Port Name
CapSense:Cmod	P4_2
CapSense:Sns[0]	P1_1
CapSense:Sns[1]	P1_2
CapSense:Sns[2]	P1_3
CapSense:Sns[3]	P1_4
CapSense:Sns[4]	P1_5
Pin_GreenLED	P0_2 (Green)
Pin_RedLED	P1_6 (Red)
EZI2C_1:scl	P3_0 (SCL)
EZI2C_1:sda	P3_1 (SDA)

**Note:** The I2C communication lines are not used when tuning is disabled.

Figure 5-18. Pin Selection for CapSense Project

Alias	Name	Port	Pin	Lock
Cmod	\CapSense:Cmod\	P4[2] CSD:c_mod, SCB0:spi_clk	22	<input checked="" type="checkbox"/>
LinearSlider0_e0_LS	\CapSense:Sns[0]\	P1[1] OA0:vminus, TCPWM2:line_out_compl	38	<input checked="" type="checkbox"/>
LinearSlider0_e1_LS	\CapSense:Sns[1]\	P1[2] OA0:vout_10x, TCPWM3:line_out	39	<input checked="" type="checkbox"/>
LinearSlider0_e2_LS	\CapSense:Sns[2]\	P1[3] OA1:vout_10x, TCPWM3:line_out_compl	40	<input checked="" type="checkbox"/>
LinearSlider0_e3_LS	\CapSense:Sns[3]\	P1[4] OA1:vminus	41	<input checked="" type="checkbox"/>
LinearSlider0_e4_LS	\CapSense:Sns[4]\	P1[5] OA1:vplus	42	<input checked="" type="checkbox"/>
	\EZI2C_1:scl\	P3[0] TCPWM0:line_out, SCB1:uart_rx, SCB1:i2c scl, SCB1:spi mosi	11	<input checked="" type="checkbox"/>
	\EZI2C_1:sda\	P3[1] TCPWM0:line_out_compl, SCB1:uart_tx, SCB1:i2c sda, SCB1:spi miso	12	<input checked="" type="checkbox"/>
	Pin_GreenLED	P0[2] COMP2:inp, SCB0:spi_ssel[3]	26	<input checked="" type="checkbox"/>
	Pin_RedLED	P1[6] OA0:vplus alt	43	<input checked="" type="checkbox"/>

### 5.4.1.3 Flow Chart

Figure 5-19 shows the flow chart of code implemented in *main.c*.

Figure 5-19. CapSense Project Flow Chart

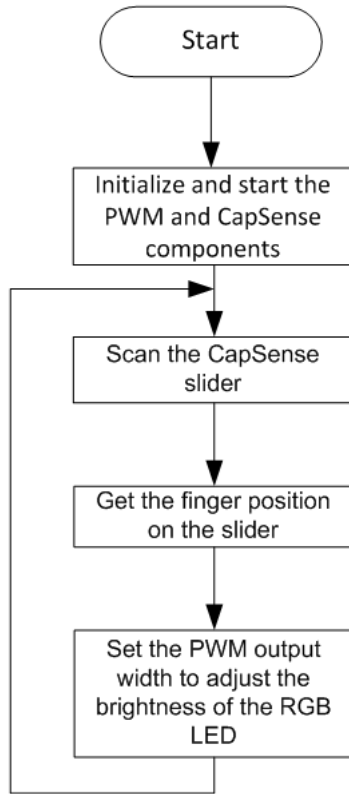

### 5.4.1.4 Verify Output

The brightness of the green and red LEDs are varied based on the position of the user’s finger on the CapSense slider. When the finger is on segment 5 (P1[5]) of the slider, the green LED is brighter than the red LED; when the finger is on segment 1 (P1[1]) of the slider, the red LED is brighter than the green LED.

## 5.4.2 CapSense (With Tuning)

### 5.4.2.1 Project Description

This code example demonstrates CapSense tuning on PSoC 4 using the "Tuner" to monitor CapSense outputs. The CapSense outputs such as rawcounts, baseline, and signal (difference count) can be monitored on the Tuner GUI. The project uses the auto-tuning feature, which sets all CapSense parameters to the optimum values automatically. The parameter settings can be monitored in the GUI but cannot be altered. In the manual tuning method, parameter settings can be changed in the GUI and the resulting output can be seen.

The code example uses the five-segment CapSense slider on the board. Each capacitive sensor on the slider is scanned using Cypress's CapSense Sigma Delta (CSD) algorithm implemented in the CapSense component. The code uses tuner APIs. The tuner API `CapSense_TunerComm()` is used in the main loop to scan sensors, which also sends the CapSense variables RawCounts, Baseline, and Difference Counts (Signal) to the PC GUI through I2C communication.

In this example, the brightness of the green and red LEDs are varied, based on the position of the user's finger on the CapSense slider.

See [Figure 5-17](#) for the project schematic.

### 5.4.2.2 Hardware Connections

No specific hardware connections are required for this project because all connections are hard-wired on the board. Open `CapSense.cydwr` in the Workspace Explorer and select the suitable pins.

See [Table 5-4](#) and [Figure 5-18](#) for the CapSense project pin connections.

### 5.4.2.3 Flow Chart

Figure 5-20. CapSense with Tuning Flow Chart

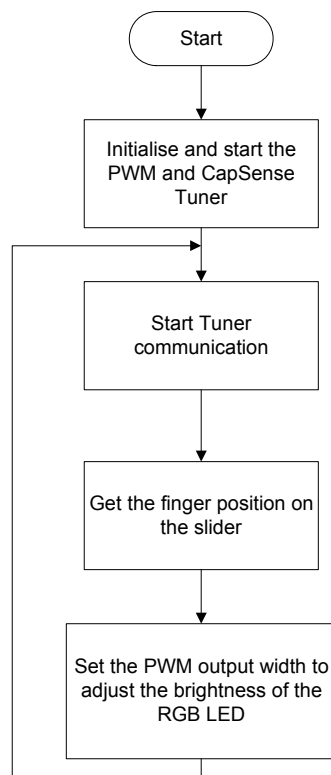

### 5.4.2.4 Launching Tuner GUI

The Tuner GUI from PSoC Creator should be up and running for the code example to work. To launch the GUI follow these steps:

1. Go to the project's *TopDesign.cysch* file.

Figure 5-21. Top Design File

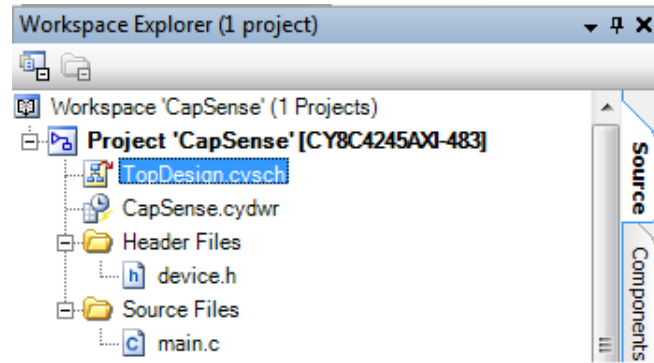

2. To open the tuner, right-click on the CapSense\_CSD component in PSoC Creator and click **Launch Tuner**.

Figure 5-22. Launch Tuner

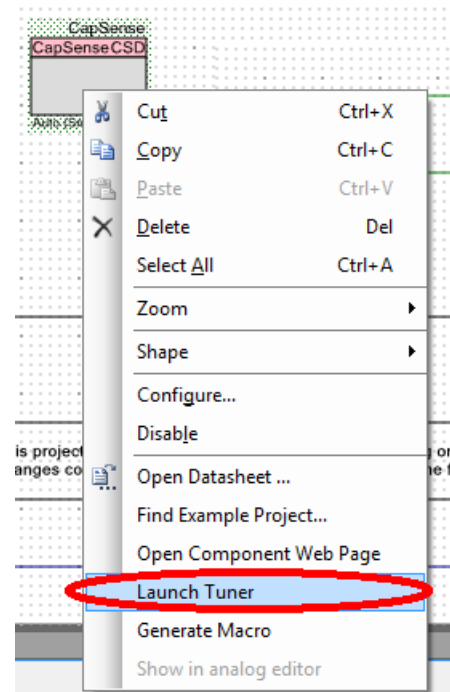

3. The Tuner GUI opens. Click **Configuration** to open the configuration window.

Figure 5-23. Tuner GUI

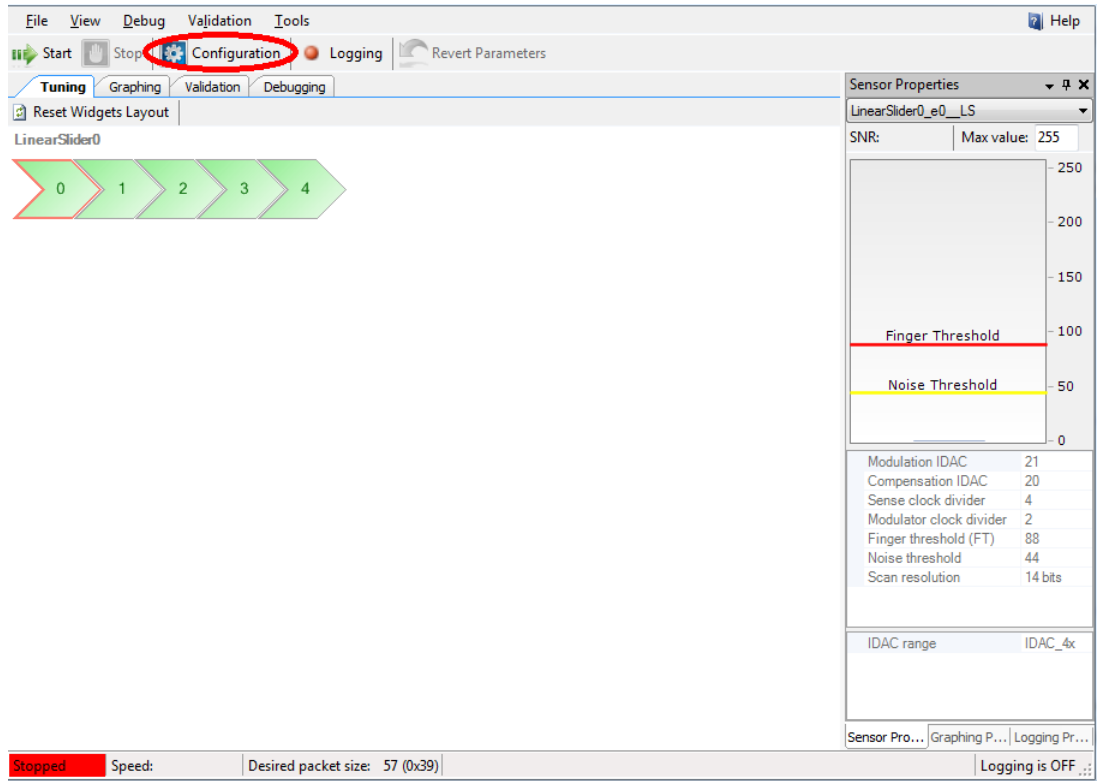

4. Set the I2C communication parameters, as shown in the following figure.

Figure 5-24. I2C Communication

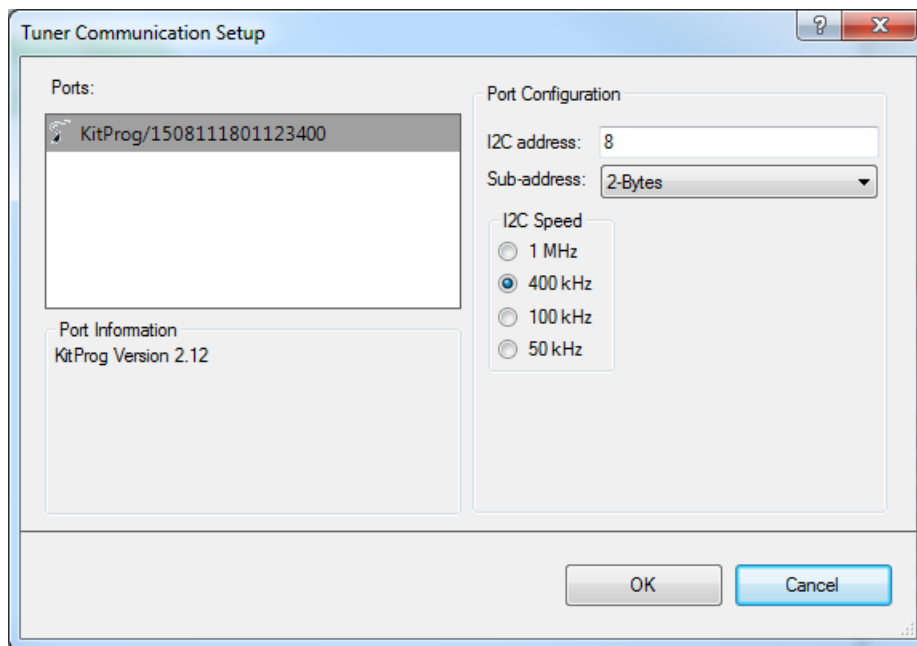

5. Click **OK** to apply the settings.

### 5.4.2.5 Verify Output

1. To start the scanning and communication process, click **Start**.

Figure 5-25. Start Communication

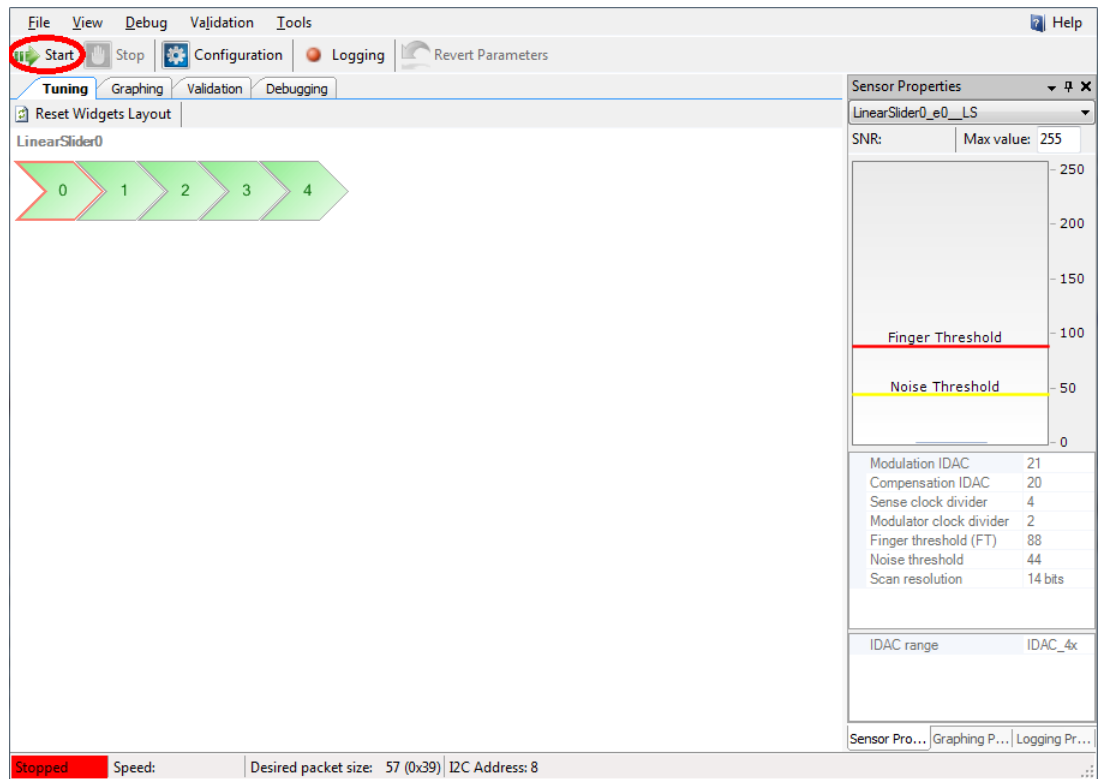

2. Select a sensor in the Tuning tab. A red outline is seen on the selected sensor. Different CapSense parameters are shown in Sensor Properties tab on the bottom-right. You cannot edit the settings because auto-tuning is used in this project; auto-tuning automatically sets all the parameters. Touch the selected sensor and observe the response in the tuner window.

**Note:** The board is designed according to layout guidelines for CapSense (best practices) for 1.5-mm overlay. Therefore, it is recommended that an overlay (not shipped with the kit) be used while using the CapSense code example with tuning.

Figure 5-26. Sensor Tuning

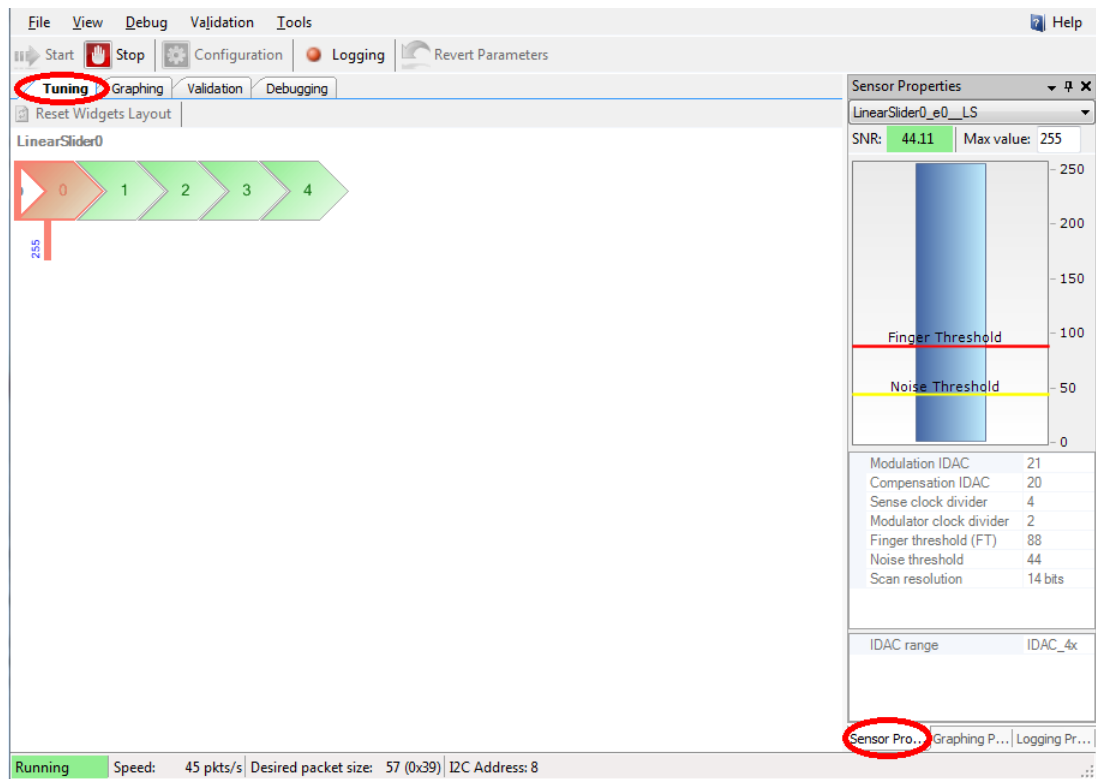

3. In the Graphing tab, the CapSense results: Raw counts, Baseline, Signal (difference count) and On/Off status for each sensor are represented as a graph. Click the **Graphing Properties** tab on the bottom-right to select the slider element for which the CapSense results are to be shown in graphing tab.

- Select the sensor parameters to observe, as shown in the following figure. The graph of the selected parameters is shown.

Figure 5-27. Sensor Parameter Graph

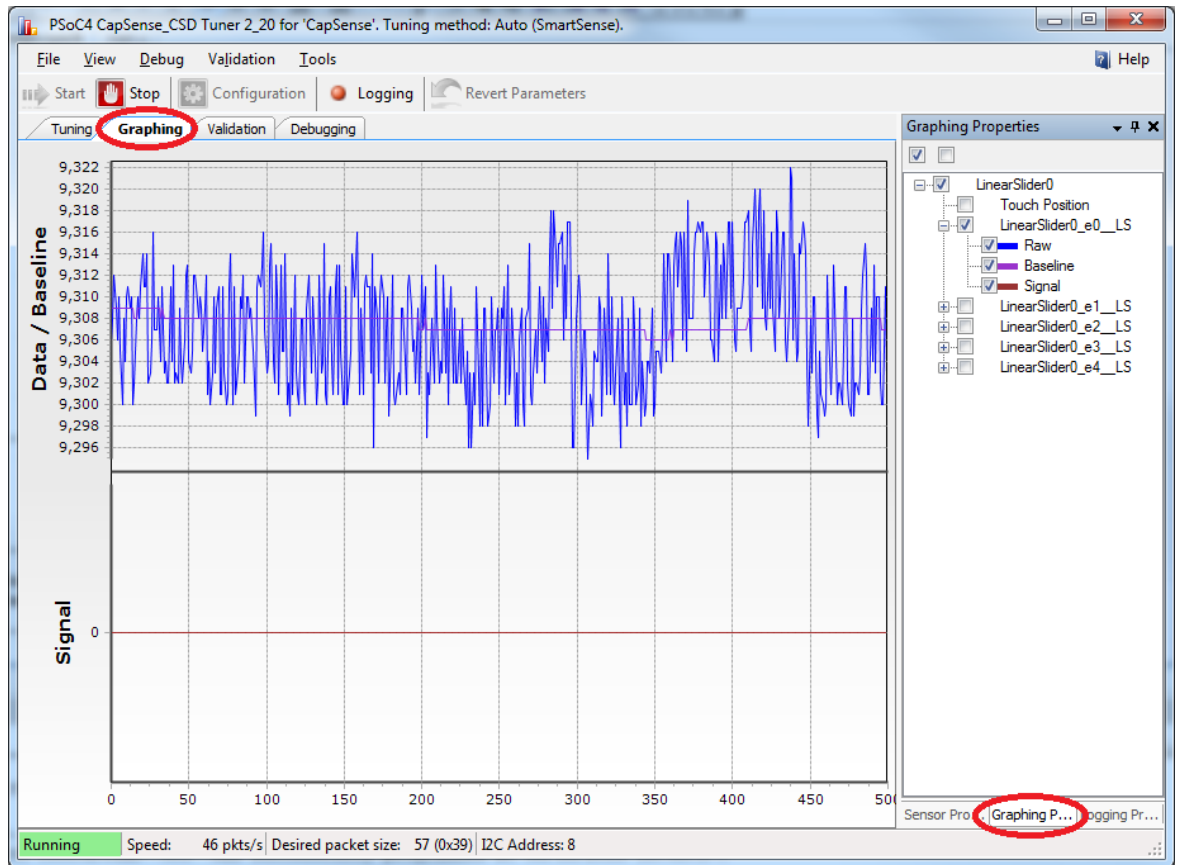



5. Touch a sensor or slider element and see the increase in raw counts.

Figure 5-28. Raw Count Increase

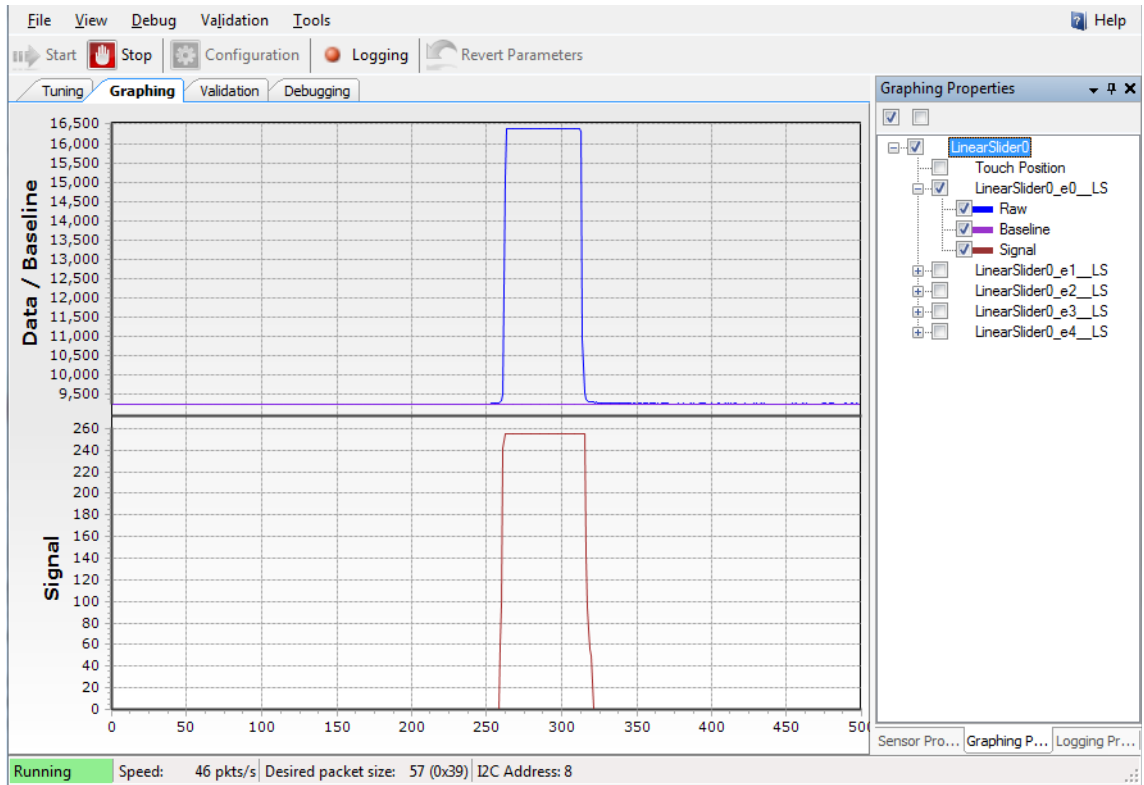

## 6. Advanced Topics



### 6.1 Using PSoC 5LP as USB-UART Bridge

The PSoC 5LP serves as a USB-UART bridge, which can communicate with the COM terminal software. This section explains how to create a PSoC 4 code example to communicate with the COM terminal software. This project is available with other code examples for the PSoC 4 Pioneer Kit at the element14 web page, [100 Projects in 100 days](#).

Users who have a Windows operating system that does not have HyperTerminal can use an alternate terminal software such as PuTTY.

1. Create a new project targeting the PSoC 4 device in PSoC Creator. Select an appropriate location for your project and rename the project as required.

Figure 6-1. Opening New Project from PSoC Creator

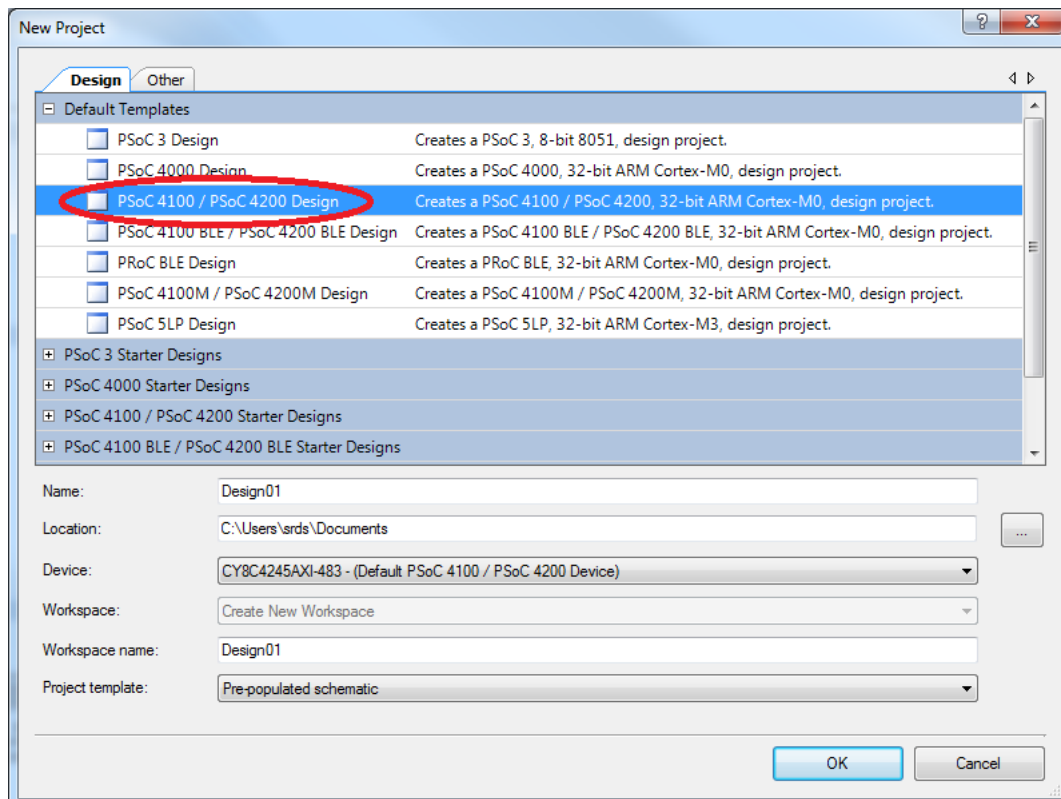

2. Drag and drop a UART (SCB) component to the top design.

Figure 6-2. UART Component Under Component Catalog

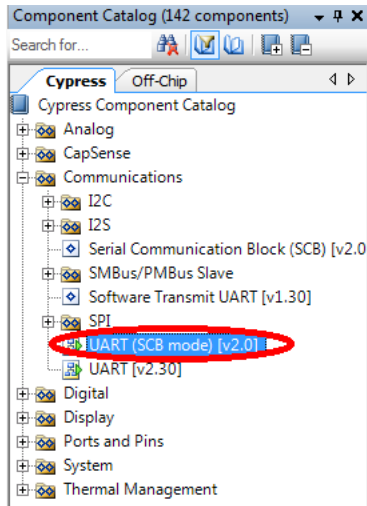

3. To configure the UART, double-click or right-click on the UART component and select **Configure**.

Figure 6-3. Open UART Configuration Window

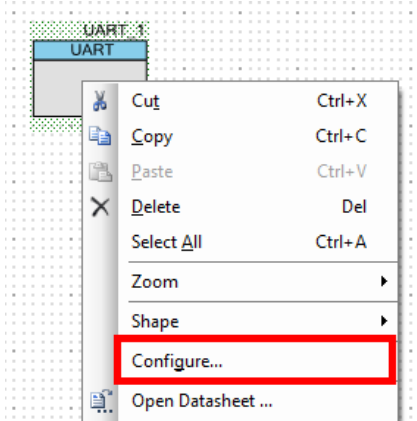

4. Configure the UART as shown in the following figures.

Figure 6-4. UART Configuration Window

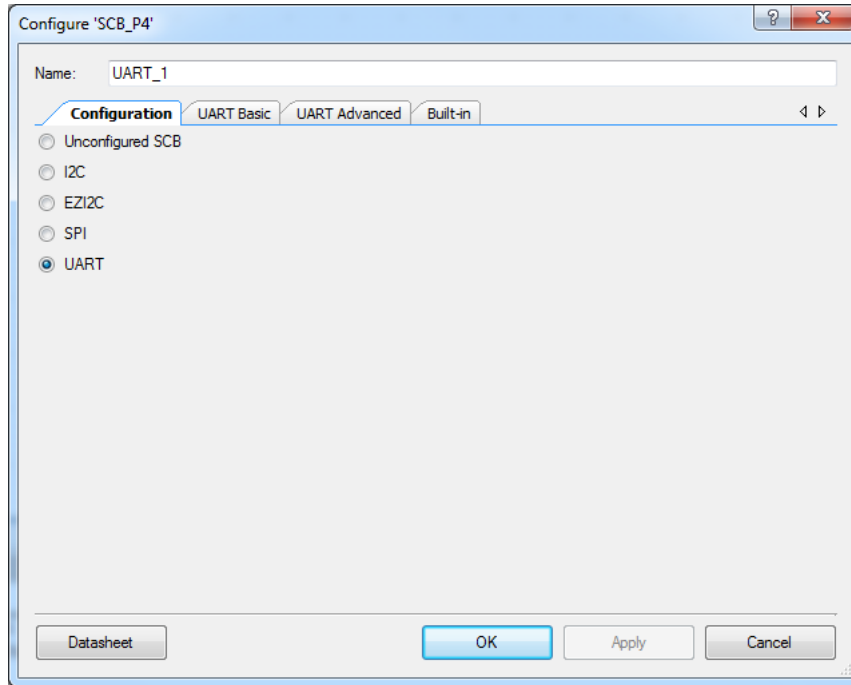

Figure 6-5. UART Basic Configuration Window

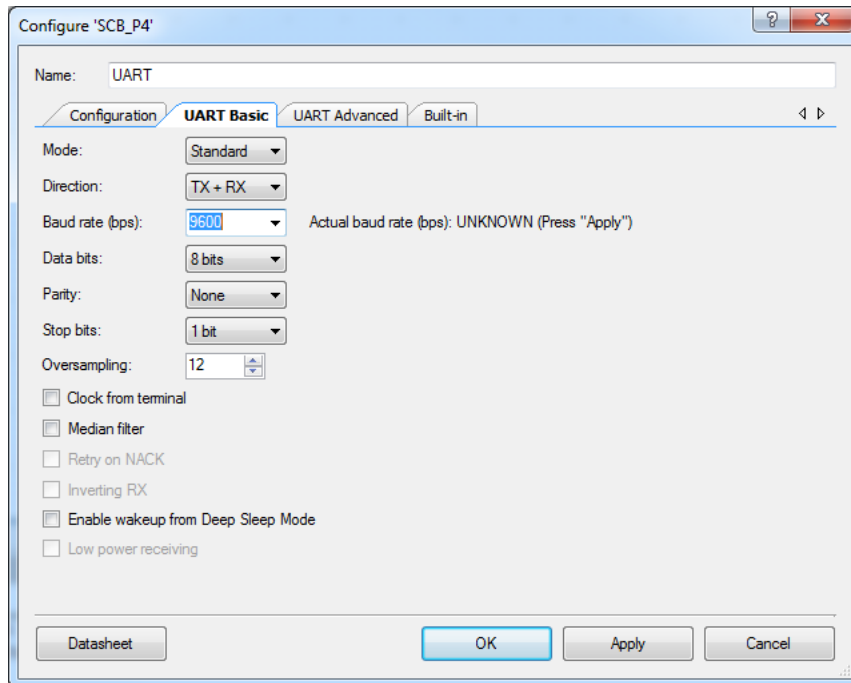
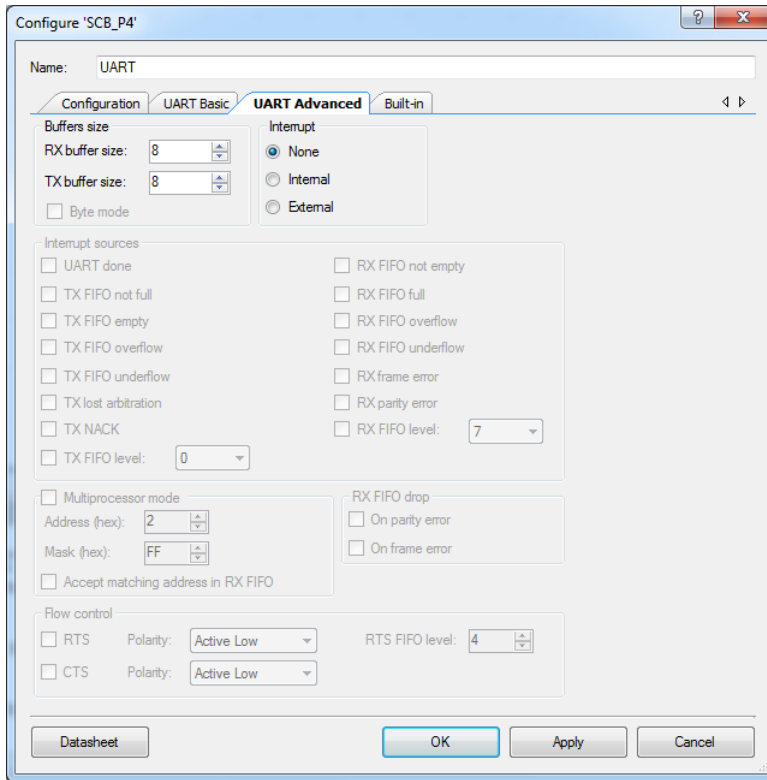

Figure 6-6. UART Advanced Configuration Window



5. Click **Apply** and then **OK** to save the changes made to UART configuration.
6. Select **P0[4]** for UART RX and **P0[5]** for UART TX in the **Pins** tab of <Project.cydwr>.

Figure 6-7. Pin Selection

Alias	Name /	Port	Pin	Lock
\UART:rx\	P0[4] SCB1:uart_rx, SCB1:i2c_scl, SCB1:spi_mosi		28	<input checked="" type="checkbox"/>
\UART:tx\	P0[5] SCB1:uart_tx, SCB1:i2c_sda, SCB1:spi_miso		29	<input checked="" type="checkbox"/>

7. Place the following code in your *main.c* project file. The code will echo any UART data received.

```
int main()
{
    uint8 ch;

    /* Start SCB UART TX+RX operation */
    UART_Start();

    /* Transmit String through UART TX Line */
    UART_UartPutString("CY8CKIT-042 USB-UART");

    for(;;)
    {
        /* Get received character or zero if nothing has been received yet
        */
        ch = UART_UartGetChar();

        if(0u != ch)
        {
            /* Send the data through UART. This functions is blocking and waits until
            there is an entry into the TX FIFO. */
            UART_UartPutChar(ch);
        }
    }
}
```

- Build the project by clicking **Build > Build {Project Name}** or **[Shift] + [F6]**. After the project is built without errors and warnings, program (by clicking **Debug > Program**) the project to PSoC 4 through the PSoC 5LP USB programmer or MiniProg3.

Connect the RX line of the PSoC 4 to J8\_10 and TX line of the PSoC 4 to J8\_9, as shown in the following figures.

Figure 6-8. UART Connection Between PSoC 4 and PSoC 5LP



Figure 6-9. Block Diagram of UART Connection Between PSoC 4 and PSoC 5LP

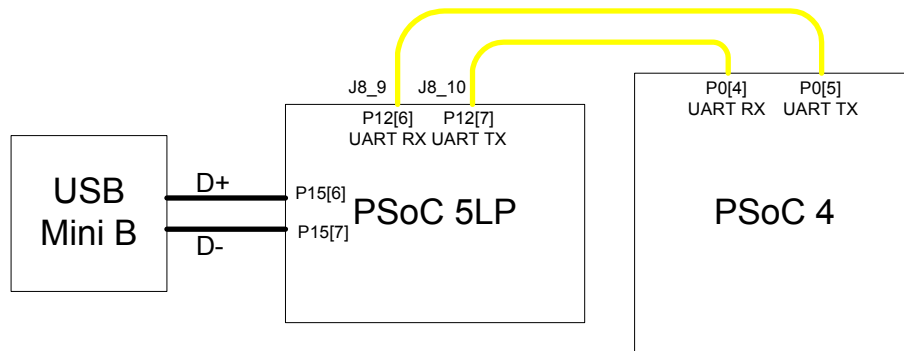

**Note:** UART RX and UART TX can be routed to any digital pin on PSoC 4 based on the configuration of the UART component. An SCB implementation of UART will route the RX and TX pins to either one of the following subsets: (P0[4], P0[5]) or (P3[0],P3[1]) or (P4[0],P4[1]).

To communicate with the PSoC 4 from the terminal software, follow this procedure:

1. Connect USB Mini B to J10. The kit enumerates as a **KitProg USB-UART** and is available under the Device Manager, Ports (COM & LPT). A communication port is assigned to the **KitProg USB-UART**.

Figure 6-10. KitProg USB-UART in Device Manager

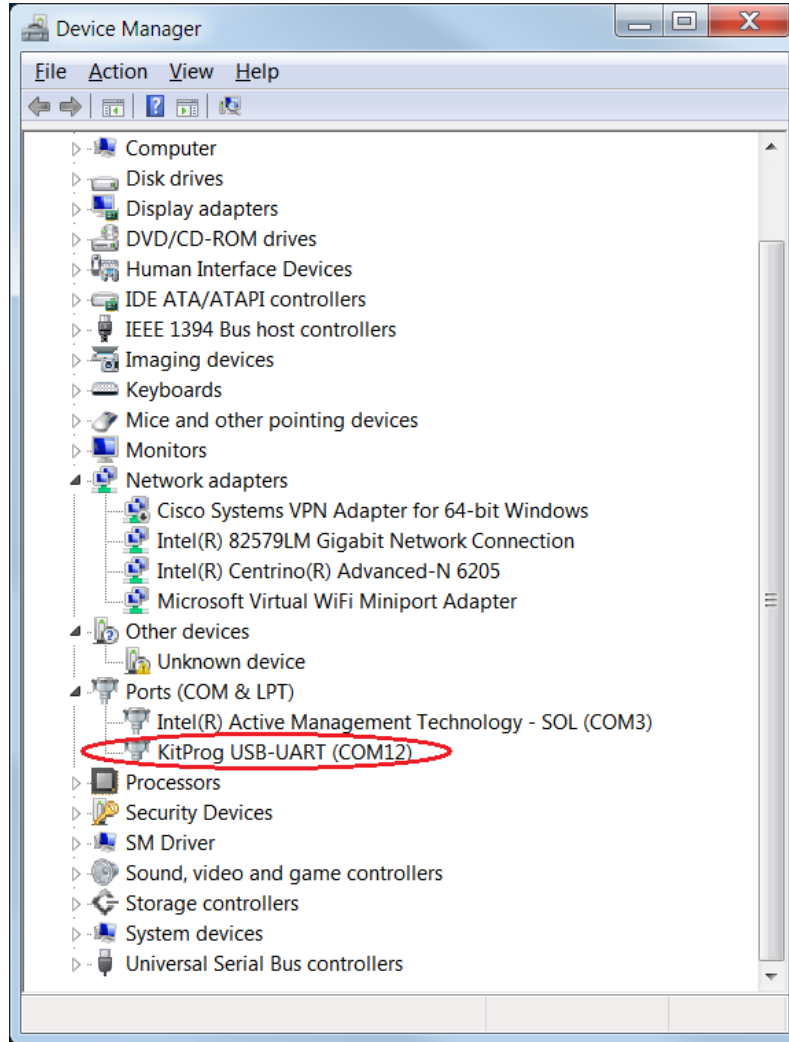



- Open HyperTerminal and select **File > New Connection** and enter a name for the new connection and click **OK**.  
For PuTTY, double-click the putty icon and select **Serial** under **Connection**.

Figure 6-11. Open New Connection

### HyperTerminal

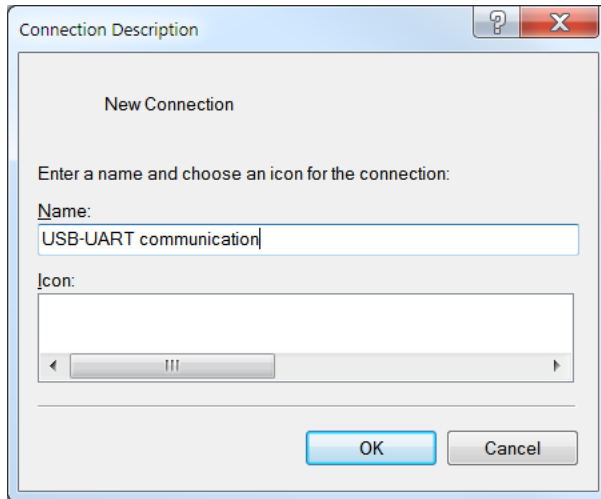

### PuTTY

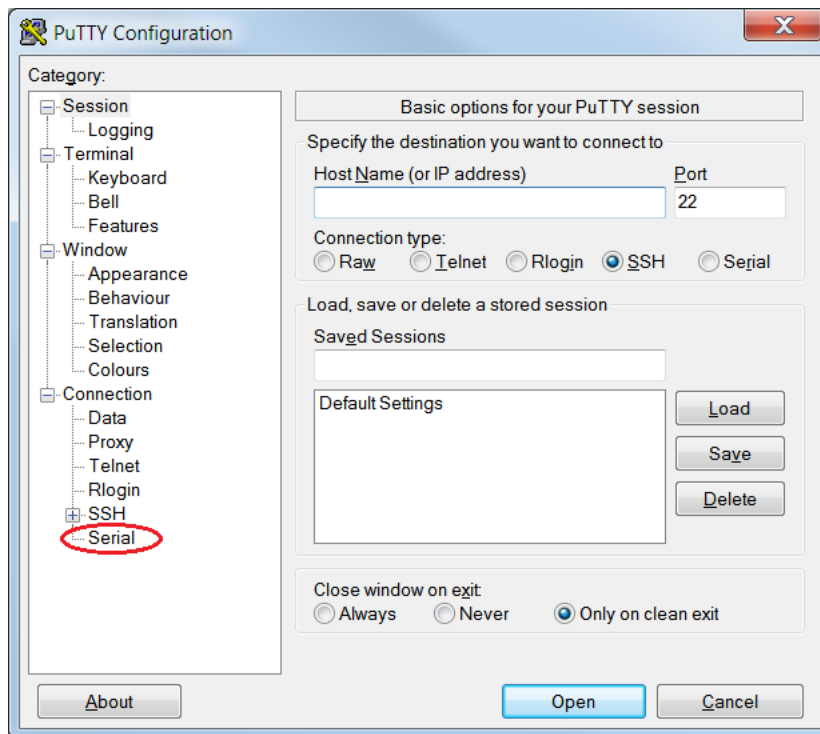

3. A new window opens, where the communication port can be selected.  
 In HyperTerminal, select **COMX** (or the specific communication port that is assigned to KitProg USB-UART) in **Connect using** and click **OK**.  
 In PuTTY enter the COMX in **Serial line to connect to**.  
 This code example uses **COM12**.

Figure 6-12. Select Communication Port

**HyperTerminal**

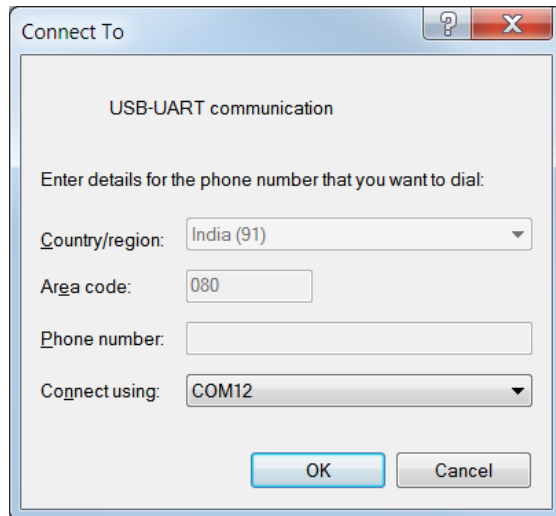

**PuTTY**

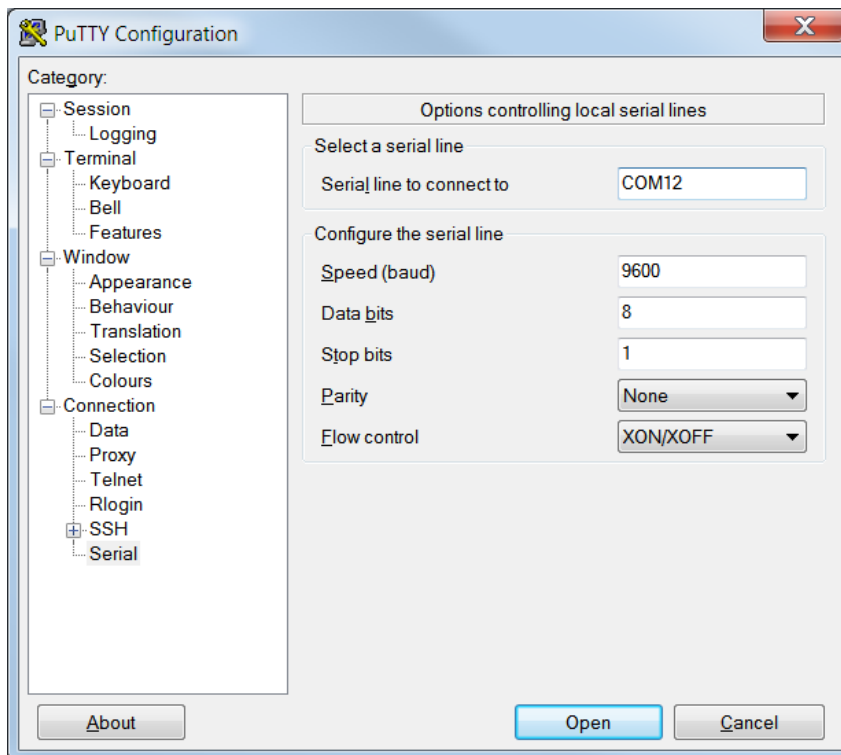

- In HyperTerminal, select 'Bits per second', 'Data bits', 'Parity', 'Stop bits', and 'Flow control' under **Port Settings** and click **OK**.

Make sure that the settings are identical to the UART settings configured for PSoC 4.

In PuTTY select 'Speed (baud)', 'Data bits', 'Stop bits', 'Parity' and 'Flow control' under **Configure the serial line**. Click **Session** and select **Serial** under **Connection type**.

**Serial line** shows the communication port (COM12) and **Speed** shows the baud rate selected. Click **Open** to start the communication.

Figure 6-13. Configure the Communication Port  
**HyperTerminal**

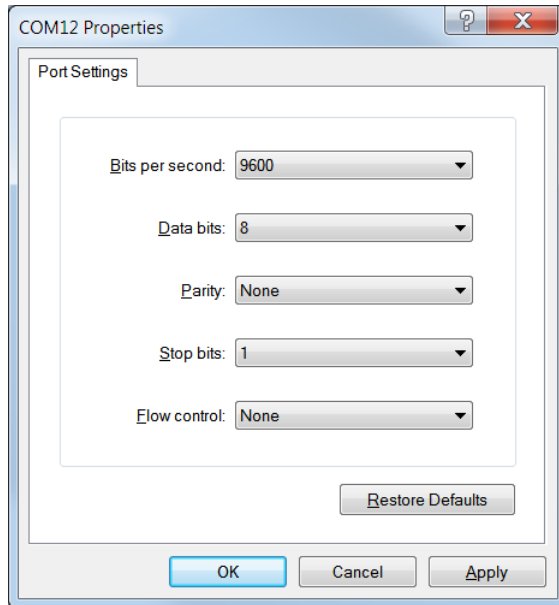

**PuTTY**

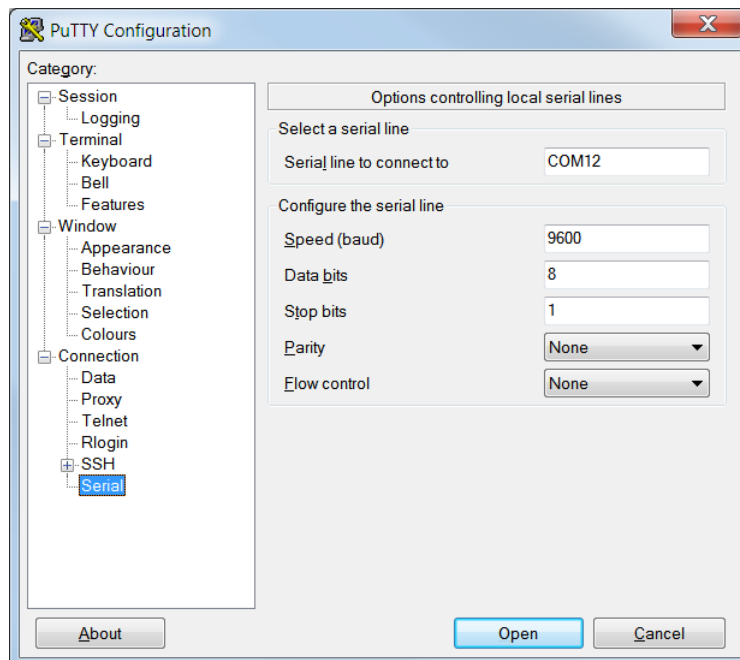
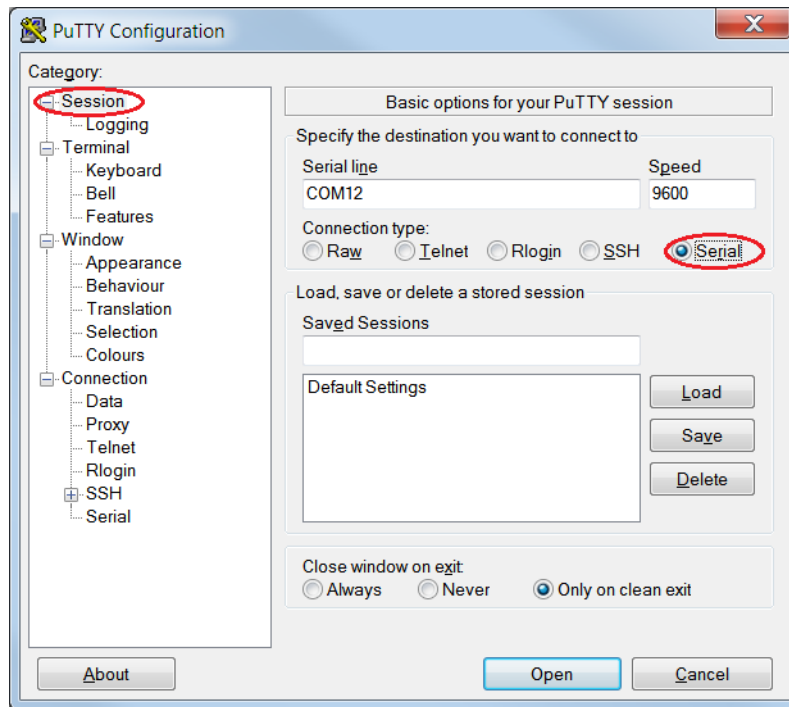

Figure 6-14. Select Communication Type in PuTTY



5. Enable **Echo typed characters locally** under **File > Properties > Settings > ASCII Setup**, to display the typed characters on HyperTerminal. In PuTTY, enable the **Force on** under **Terminal > Line discipline** options to display the typed characters on the PuTTY.

Figure 6-15. Enabling Echo of Typed Characters in HyperTerminal

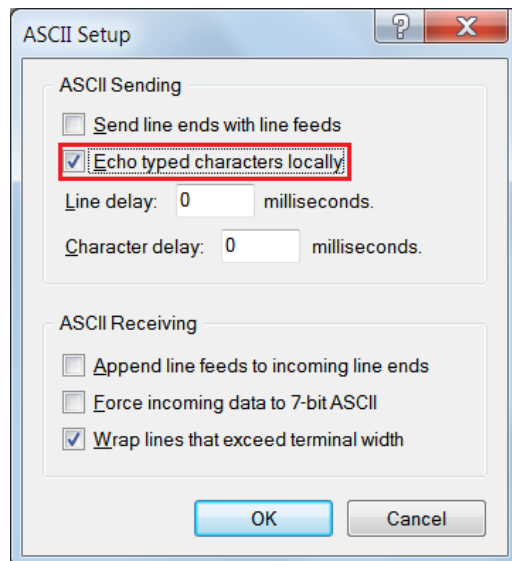
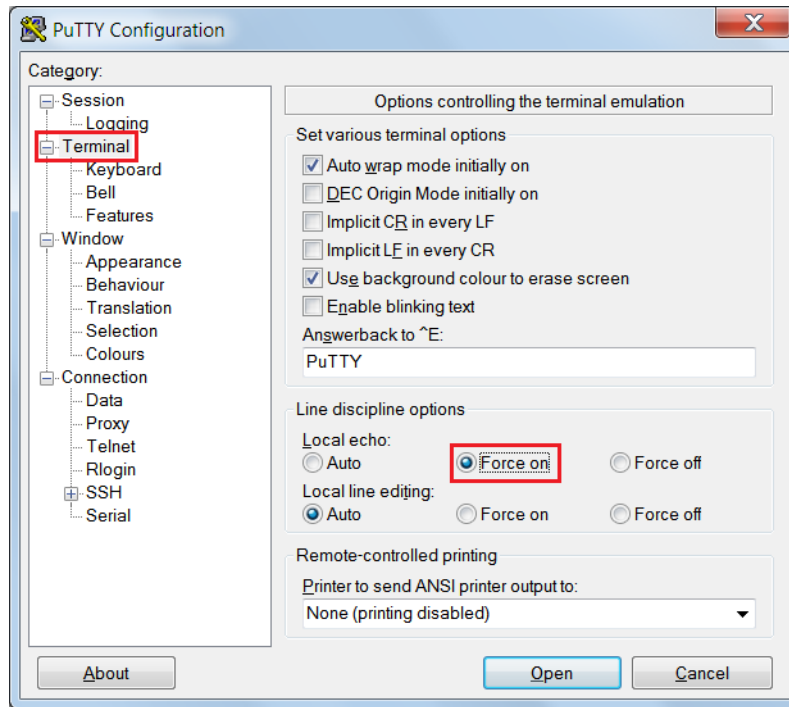

Figure 6-16. Enabling Echo of Typed Characters in PuTTY



6. The COM terminal software displays both the typed data and the looped back data from the PSoC 4 UART.

Figure 6-17. Data Displayed on HyperTerminal

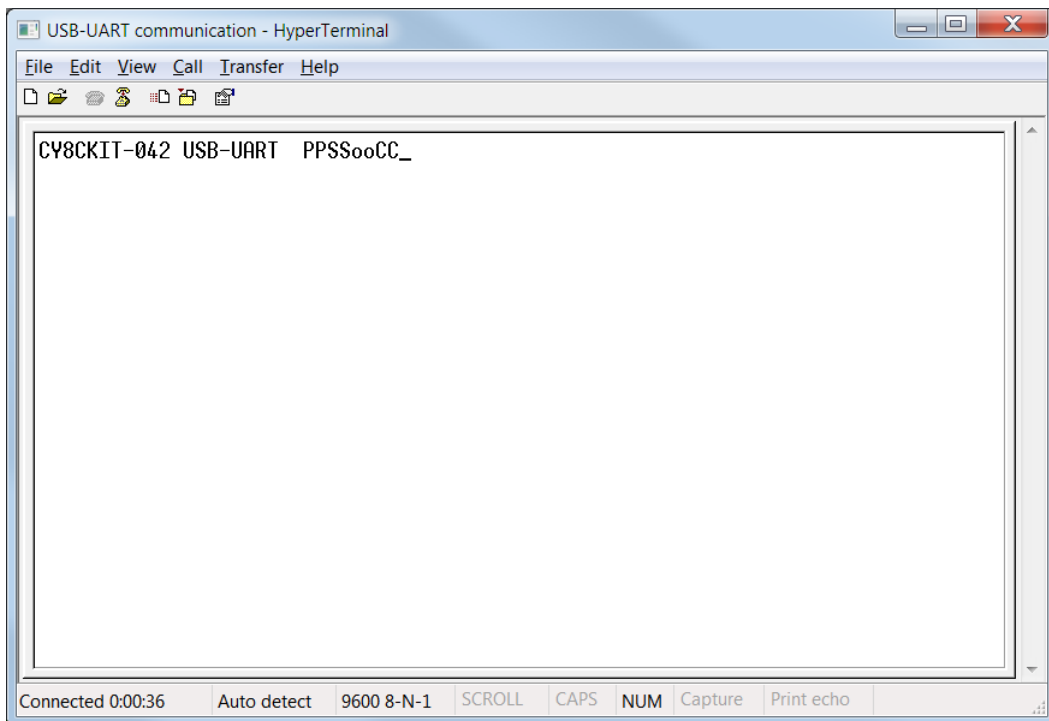
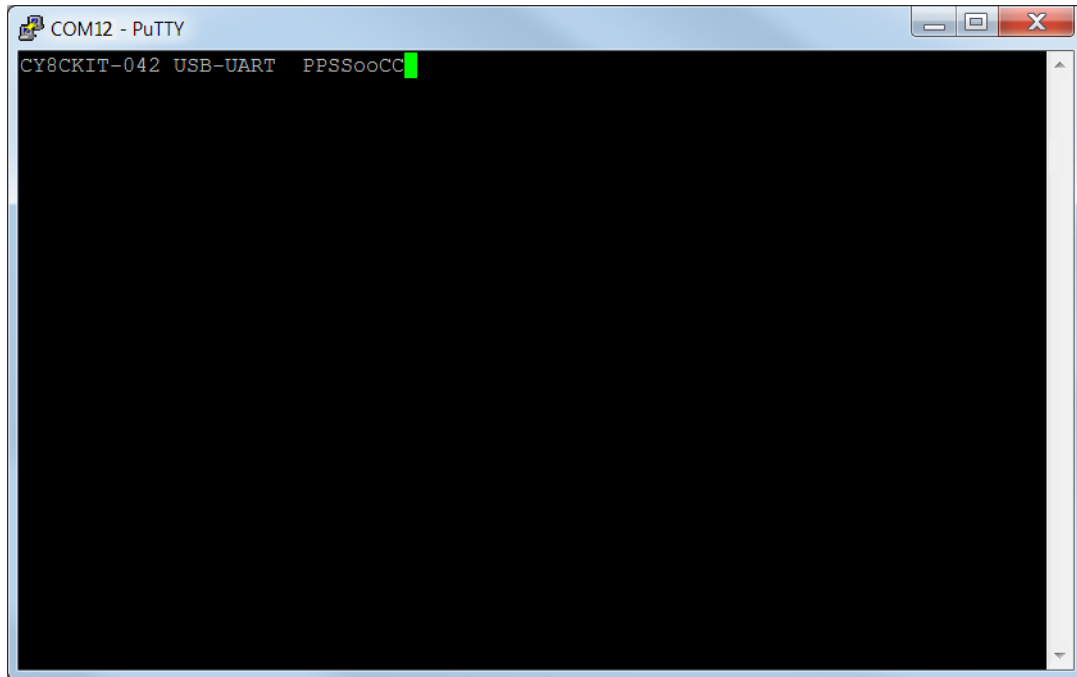

Figure 6-18. Data Displayed on PuTTY



## 6.2 Using PSoC 5LP as USB-I2C Bridge

The PSoC 5LP serves as a USB-I2C bridge, which can be used to communicate with the USB-I2C software running on the PC. This project is available with other code examples for the PSoC 4 Pioneer Kit at the element14 web page, [100 Projects in 100 days](#).

The following steps describe how to use the USB-I2C bridge, which can communicate between the BCP and the PSoC 4.

1. Create a new project targeting the PSoC 4 device in PSoC Creator.

Figure 6-19. Opening a New Project in PSoC Creator

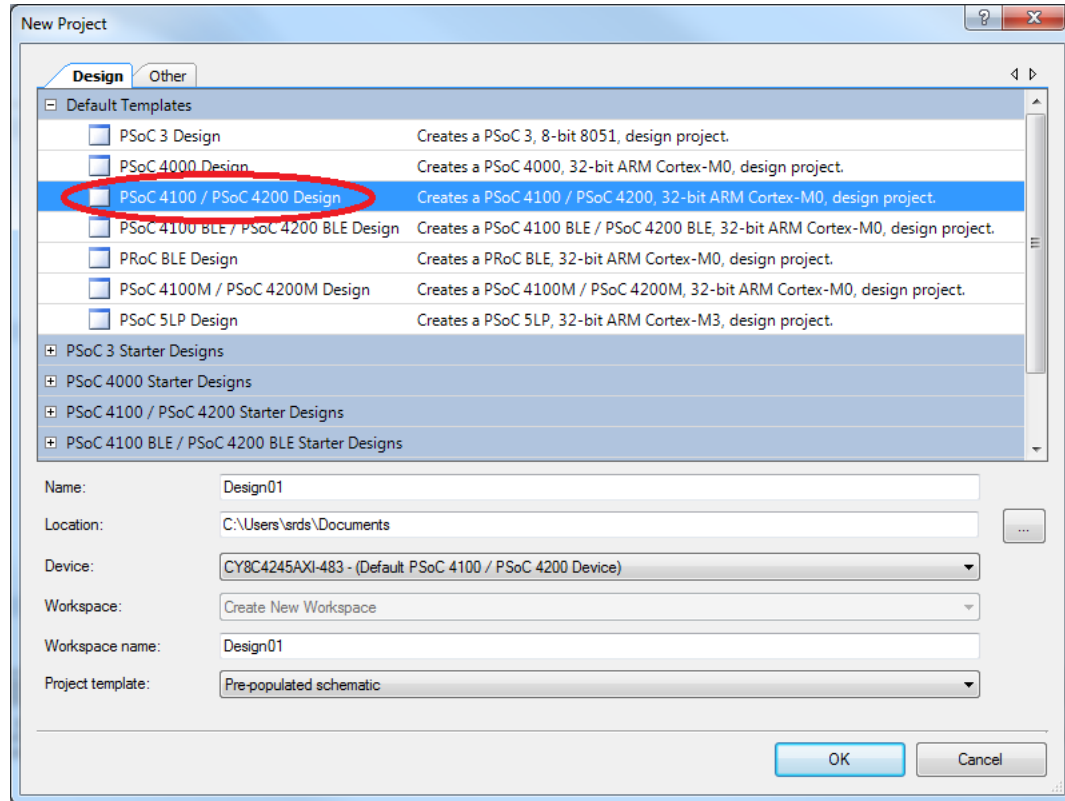

2. Drag and drop an I2C component to the top design.

Figure 6-20. I2C Component in Component Catalog

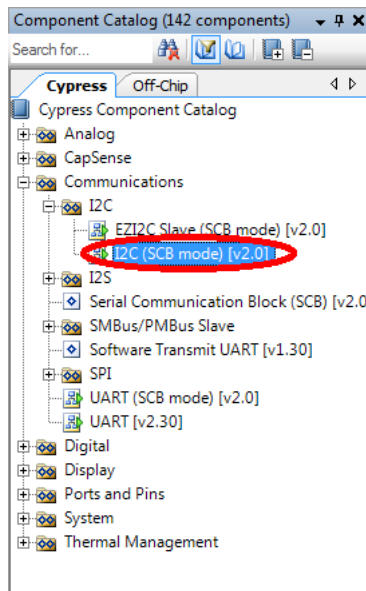

3. To configure the I2C component, double-click or right-click on the I2C component and select **Configure**.

Figure 6-21. Open I2C Configuration Window

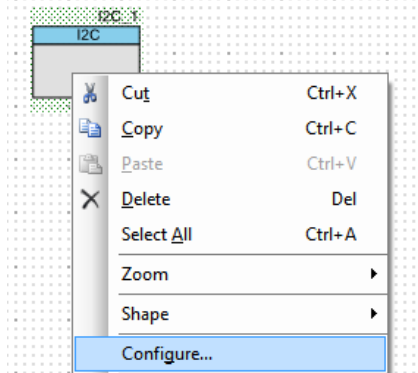



4. Configure the I2C with the following settings.

Figure 6-22. I2C Configuration Tab

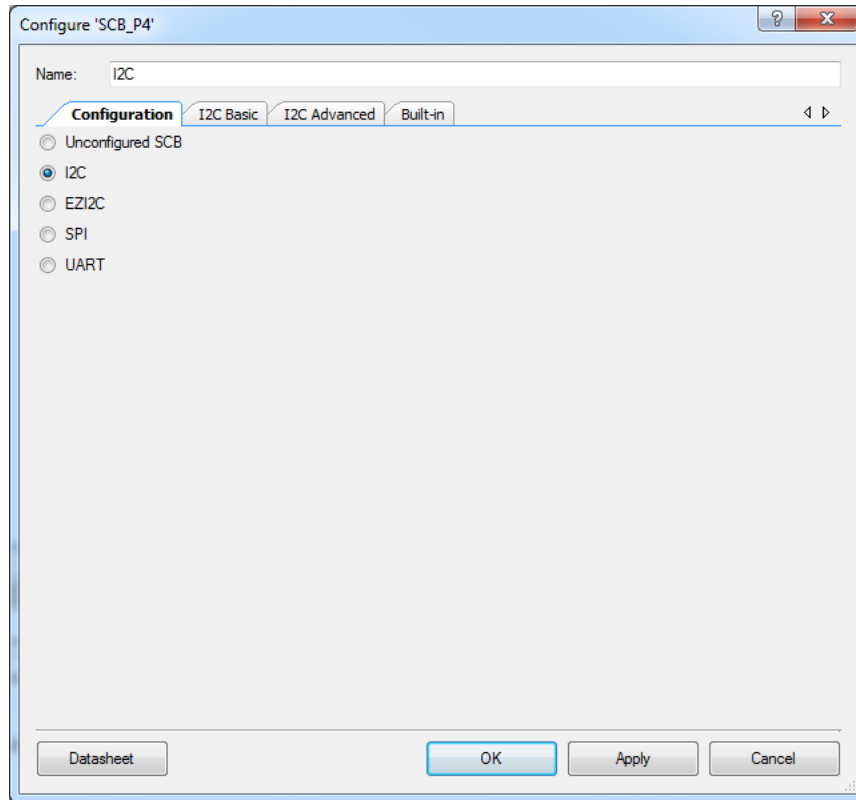

Figure 6-23. I2C Basic Tab

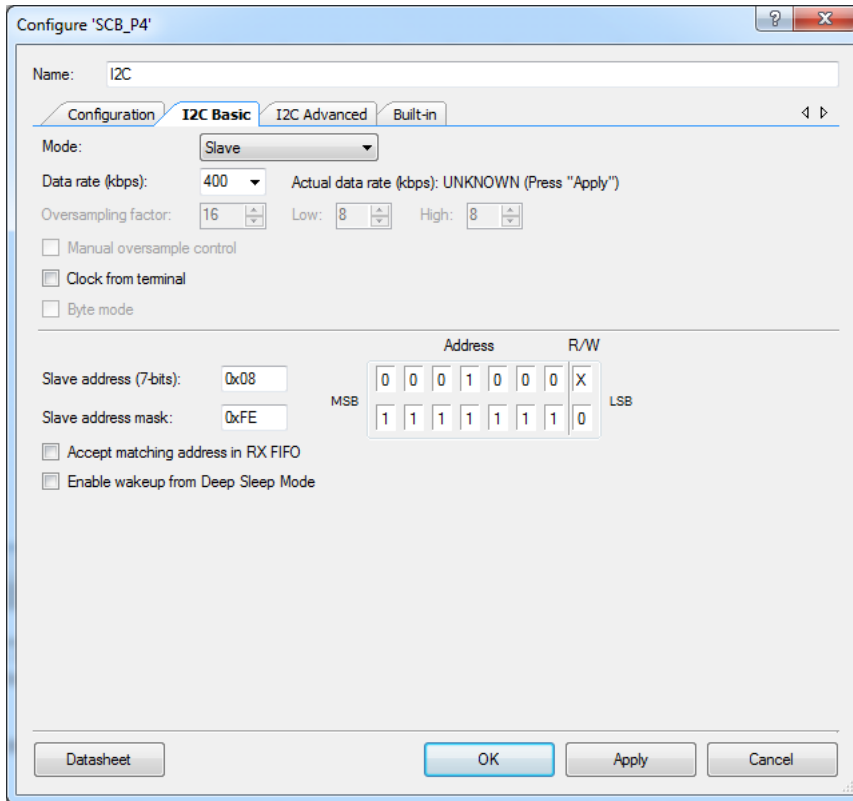
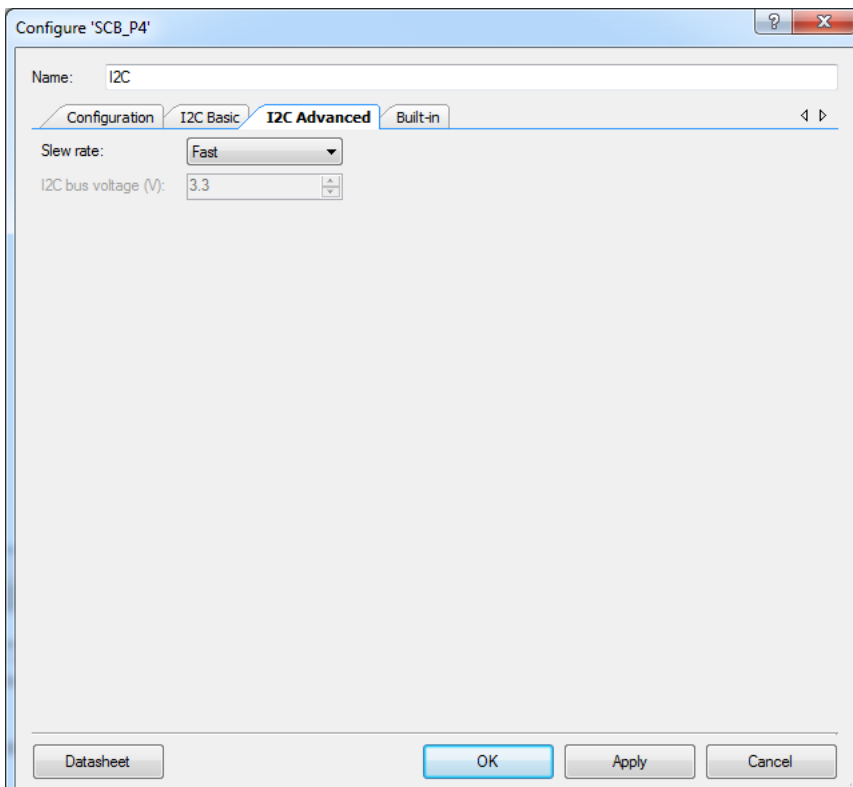

Figure 6-24. I2C Advanced Tab



5. Click **Apply** and then **OK** to save the changes.
6. Select pin **P3[0]** for the I2C SCL and pin **P3[1]** for the I2C SDA in the **Pins** tab of <project.cydwr>.

Figure 6-25. Pin Selection

Alias	Name /	Port	Pin	Lock
\I2C:scl\	P3[0] TCPWM0:line_out, SCB1:uart_rx, SCB1:i2c_scl, SCB1:spi_mosi		11	<input checked="" type="checkbox"/>
\I2C:sda\	P3[1] TCPWM0:line_out_compl, SCB1:uart_tx, SCB1:i2c_sda, SCB1:spi_miso		12	<input checked="" type="checkbox"/>

7. Place the following code in your *main.c* project file. The code will enable the PSoC 4 device to transmit and receive I2C data to and from the BCP application.

```

int main()
{

uint8 wrBuf[10]; /* I2C write buffer */
uint8 rdBuf[10]; /* I2C read buffer */
uint8 indexCntr;
uint32 byteCnt;

/* Enable the Global Interrupt */
CyGlobalIntEnable;

/* Start I2C Slave operation */
I2C_Start();

/* Initialize write buffer */
I2C_I2CSlaveInitWriteBuf((uint8 *) wrBuf, 10);

/* Initialize read buffer */
I2C_I2CSlaveInitReadBuf((uint8 *) rdBuf, 10);

for(;;) /* Loop forever */
{

/* Wait for I2C master to complete a write */
if(0u != (I2C_I2CSlaveStatus() & I2C_I2C_SSTAT_WR_CMPLT))
{

/* Read the number of bytes transferred */
byteCnt = I2C_I2CSlaveGetWriteBufSize();

/* Clear the write status bits*/
I2C_I2CSlaveClearWriteStatus();

/* Move the data written by the master to the read buffer so that the
master can read back the data */
for(indexCntr = 0; indexCntr < byteCnt; indexCntr++)

```

```

    {
rdBuf [indexCntr] = wrBuf[indexCntr]; /* Loop back the data to the read
        buffer */
    }

/* Clear the write buffer pointer so that the next write operation will
start from index 0 */
I2C_I2CSlaveClearWriteBuf();

/* Clear the read buffer pointer so that the next read operations starts
from index 0 */
I2C_I2CSlaveClearReadBuf();
}
/* If the master has read the data , reset the read buffer pointer to 0
and clear the read status */
if(0u != (I2C_I2CSlaveStatus() & I2C_I2C_SSTAT_RD_CMPLT))
{
/* Clear the read buffer pointer so that the next read operations starts
from index 0 */
I2C_I2CSlaveClearReadBuf();

/* Clear the read status bits */
I2C_I2CSlaveClearReadStatus();
}
}
}

```

6. Build the project by clicking **Build > Build Project** or **[Shift]+[F6]**. After the project is built without errors and warnings, program (**[Ctrl]+[F5]**) this code onto the PSoC 4 through the PSoC 5LP programmer or MiniProg3.
7. Open the BCP from **Start > All Programs > Cypress > Bridge Control Panel <version number>**.
8. Connect to **KitProg/** under **Connected I2C/SPI/RX8 Ports**.

Figure 6-26. Connecting to KitProg/ in BCP

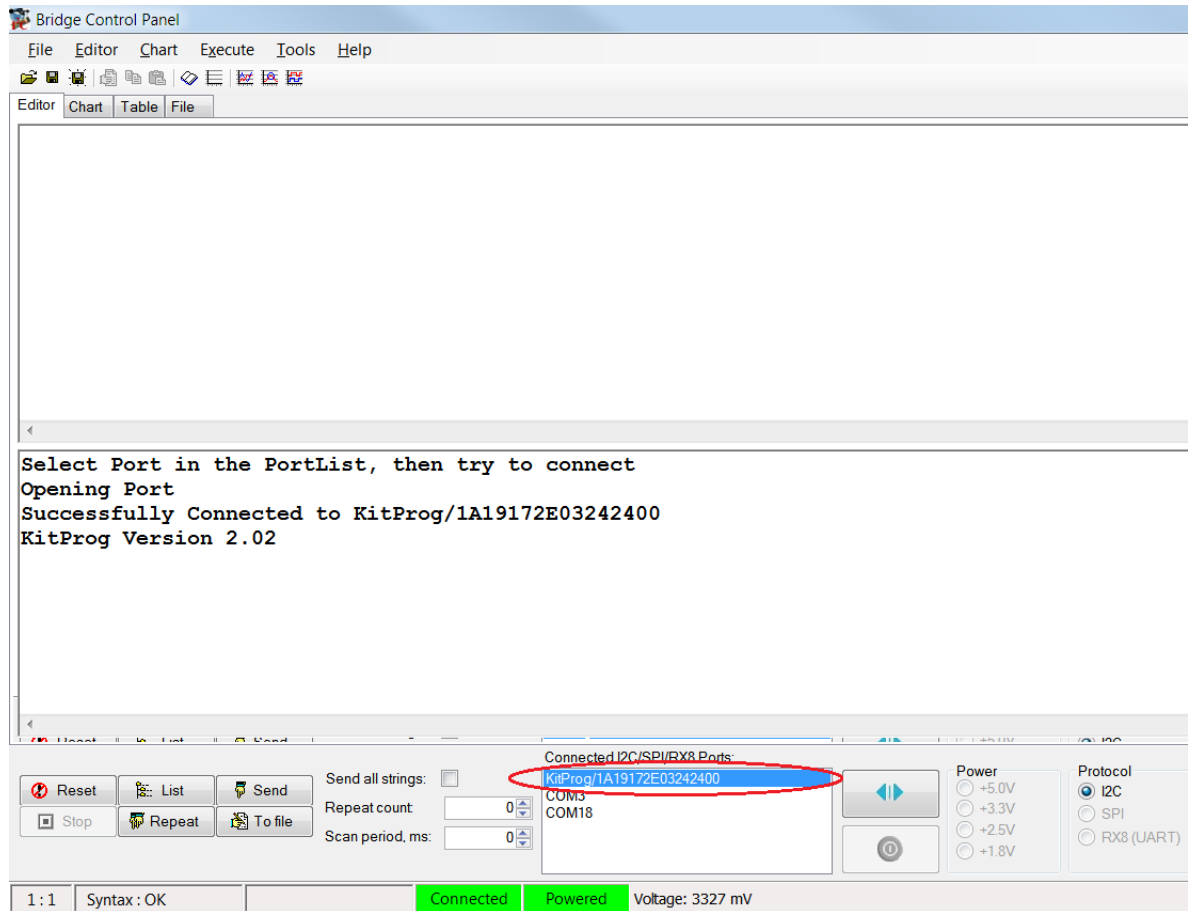

9. Open **Protocol Configuration** from the **Tools** menu and select the appropriate **I2C Speed**. Make sure the I2C speed is the same as the one configured in the I2C component. Click **OK** to close the window.

Figure 6-27. Opening Protocol Configuration Window in BCP

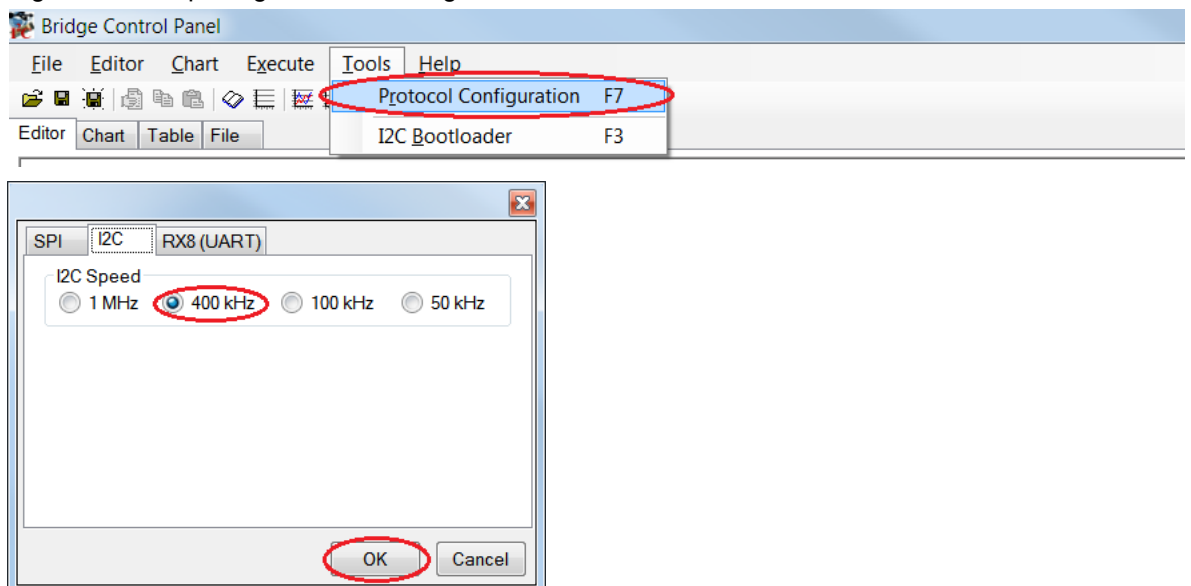

10. From the BCP, transfer five bytes of data to the I2C device with slave address 0x08. The log shows whether the transaction was successful. A '+' indication after each byte indicates that the transaction was successful and a '-' indicates that the transaction was a failure.

Figure 6-28. Entering Commands in BCP

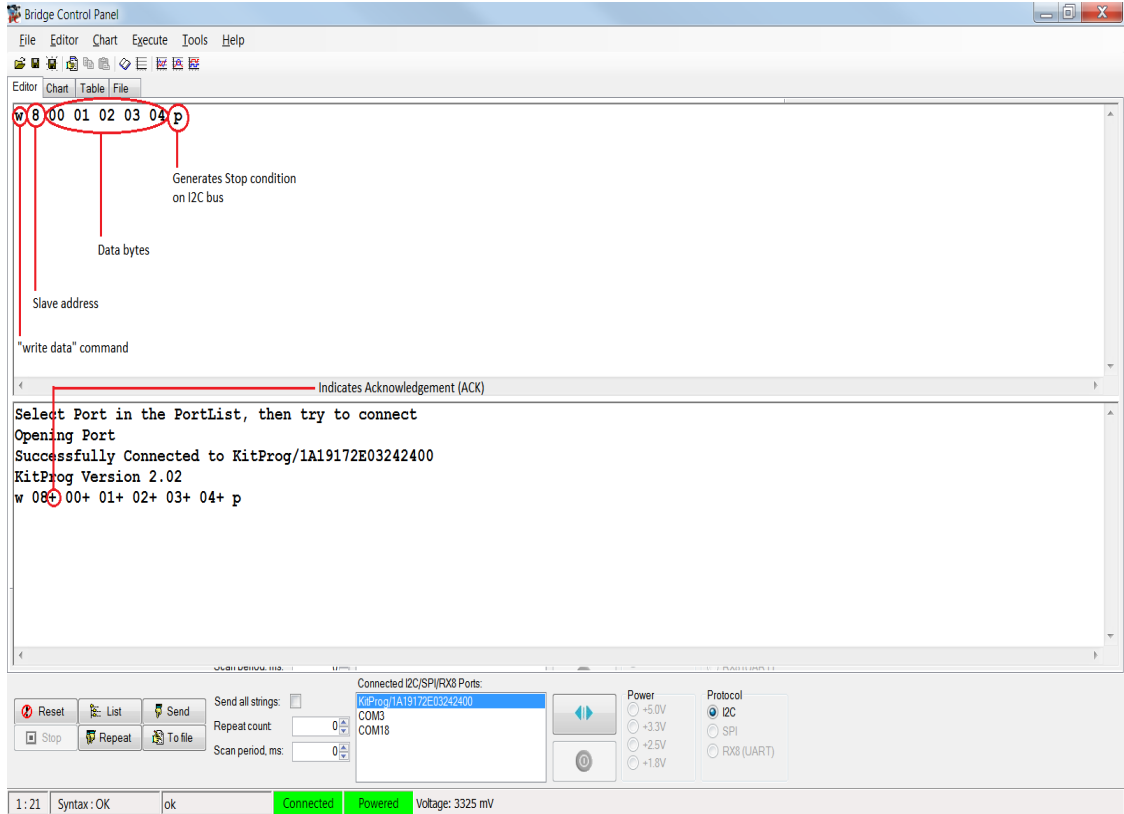
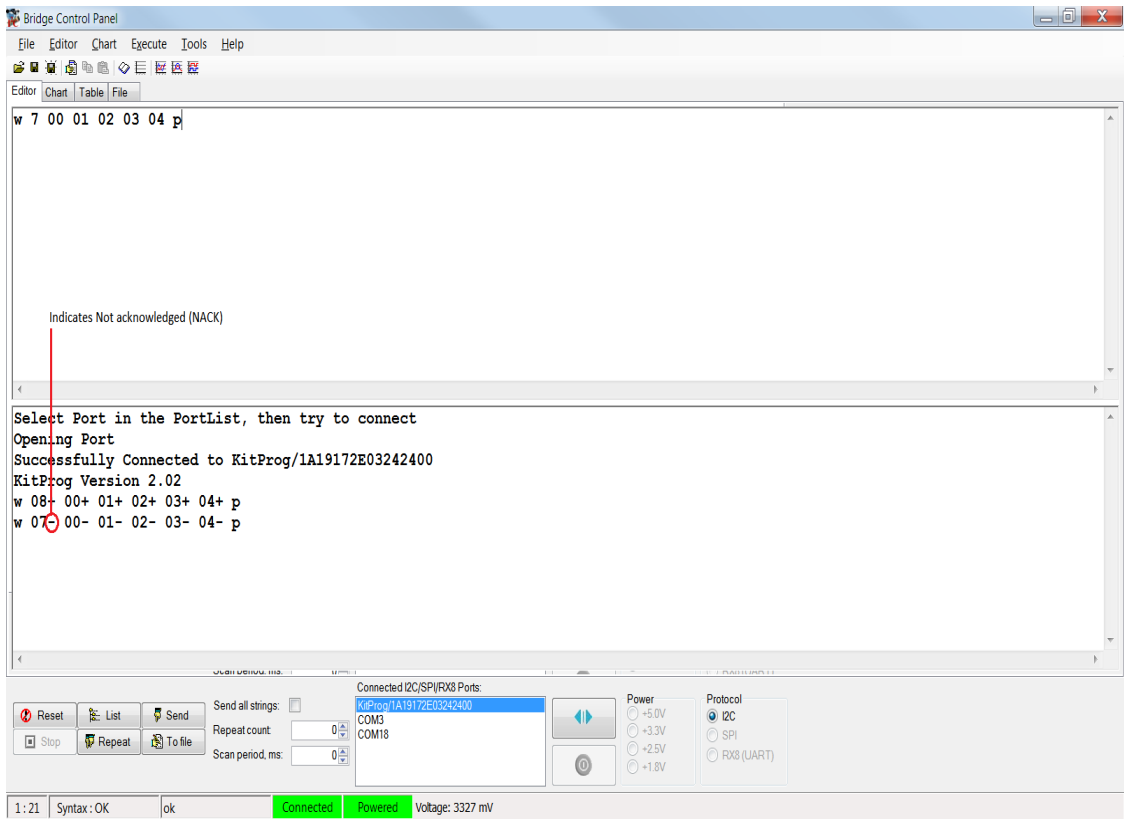
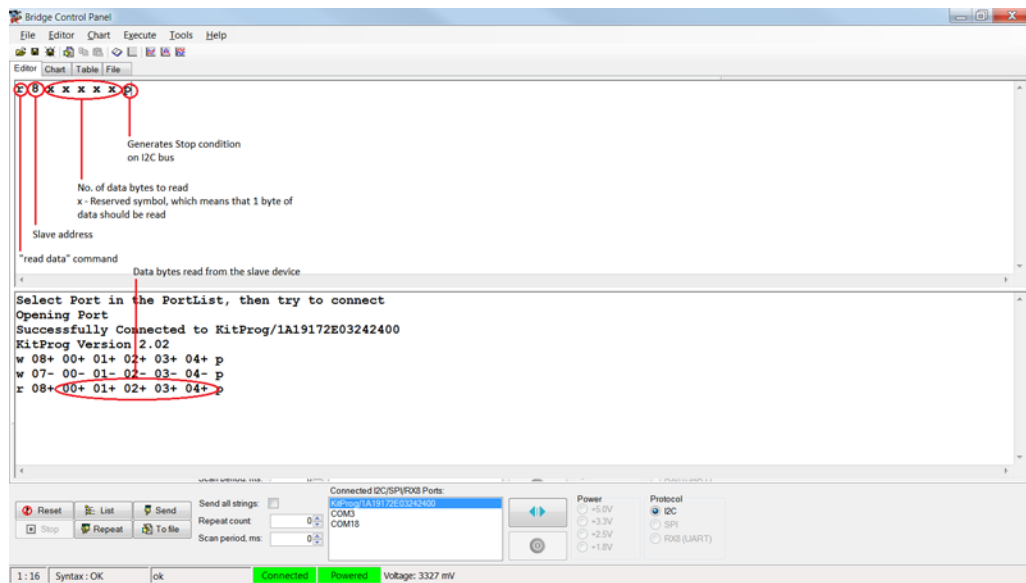

Figure 6-29. NACK Indication in BCP



11. From the BCP, read five bytes of data from the I2C slave device with slave address 0x08. The log shows whether the transaction was successful.

Figure 6-30. Read Data Bytes from the BCP



**Note:** Refer **Help Contents** under **Help** in BCP or press **[F1]** for details of I2C commands.

## 6.3 Developing Applications for PSoC 5LP

The PSoC 4 Pioneer Kit has an onboard PSoC 5LP whose primary function is that of a programmer and a bridge. You can build either a normal project or a bootloadable project using the PSoC 5LP.

The PSoC 5LP connections in the Pioneer board are summarized in [Figure 6-31](#). J8 is the I/O connector (see section [4.3.7 PSoC 5LP GPIO Header \(J8\)](#)). The USB (J10) is connected and used as the PC interface. But you can still use this USB connection to create customized USB designs.

The programming header (J7) is meant for standalone programming. This header needs to be populated. See the 'No Load Components' section in [A.6 Bill of Materials \(BOM\) on page 121](#).

Figure 6-31. PSoC 5LP Block Diagram

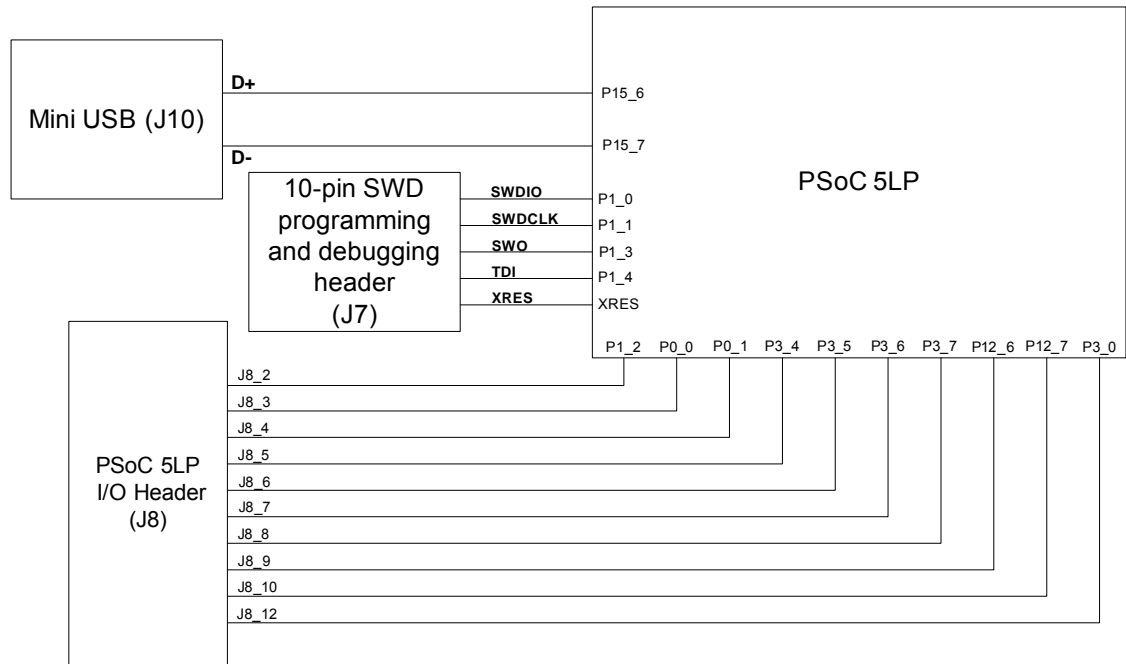

### 6.3.1 Building a Bootloadable Project for PSoC 5LP

All bootloadable applications developed for the PSoC 5LP should be based on the bootloader hex file, which is programmed onto the kit. The bootloader hex file is available in the kit files or can be downloaded from the [kit web page](#).

The hex files are included in the following kit installer directory:

```
<Install_Directory>\CY8CKIT-042 PSoC 4 Pioneer Kit\  
<version>\Firmware\Programmer\KitProg_Bootloader
```

Figure 6-32. KitProg Bootloader Hex File Location

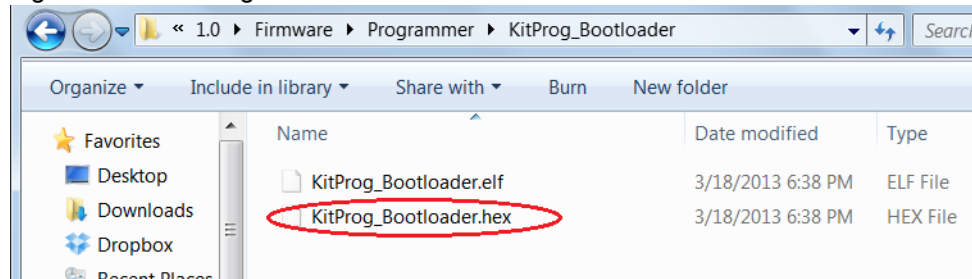



To build a bootloadable application for the PSoC 5LP, follow this procedure:

1. In PSoC Creator, choose **New > Project** and click **PSoC 5LP Design**; select **Launch Device Selector** from the drop-down list for **Device** to bring up the **Select PSoC 5LP Device** window and select **CY8C5868LTI-LP039**, as shown in [Figure 6-33](#). Click **OK**.

Figure 6-33. Opening New Project in PSoC Creator

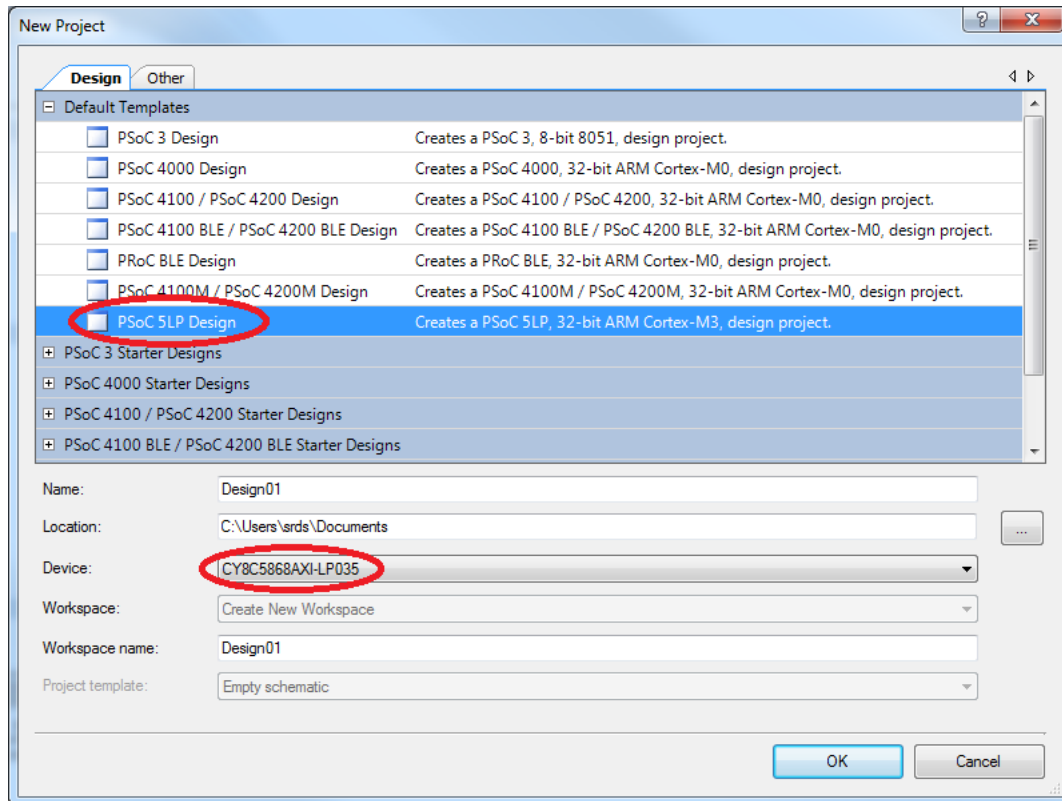
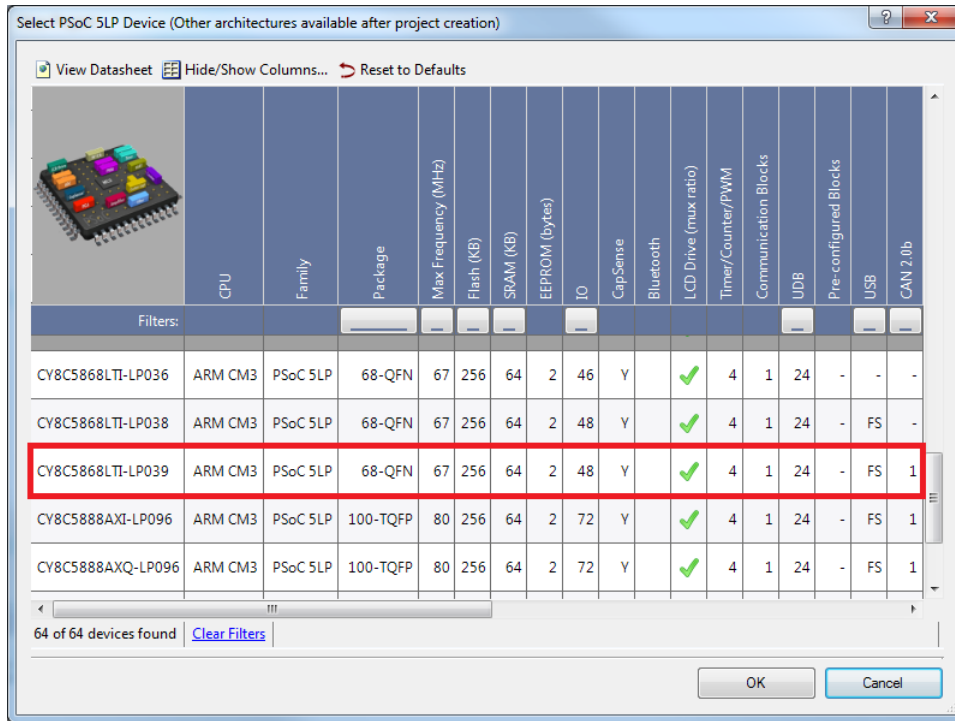
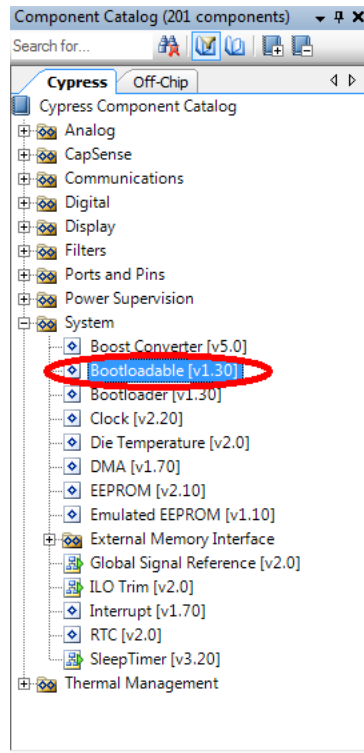

Figure 6-34. Selecting Device in PSoC Creator



2. Navigate to the Schematic view and drag and drop a bootloadable component on the top design.

Figure 6-35. Bootloadable Component in Component Catalog



Set the dependency of the Bootloadable component by selecting the **Dependencies** tab in the configuration window and clicking the **Browse** button. Select the *KitProg\_Bootloader.hex* and *KitProg\_Bootloader.elf* files; click **Open**.

Figure 6-36. Configuration Window of Bootloadable Component

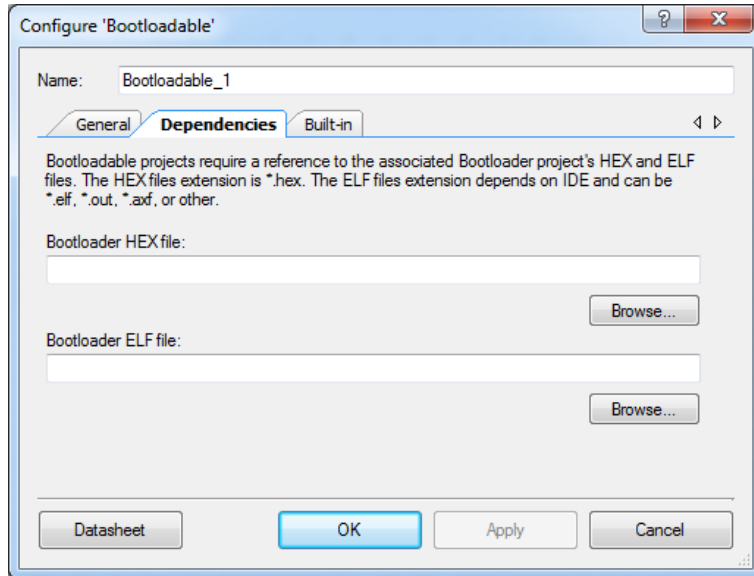

Figure 6-37. Selecting KitProg Bootloader Hex File

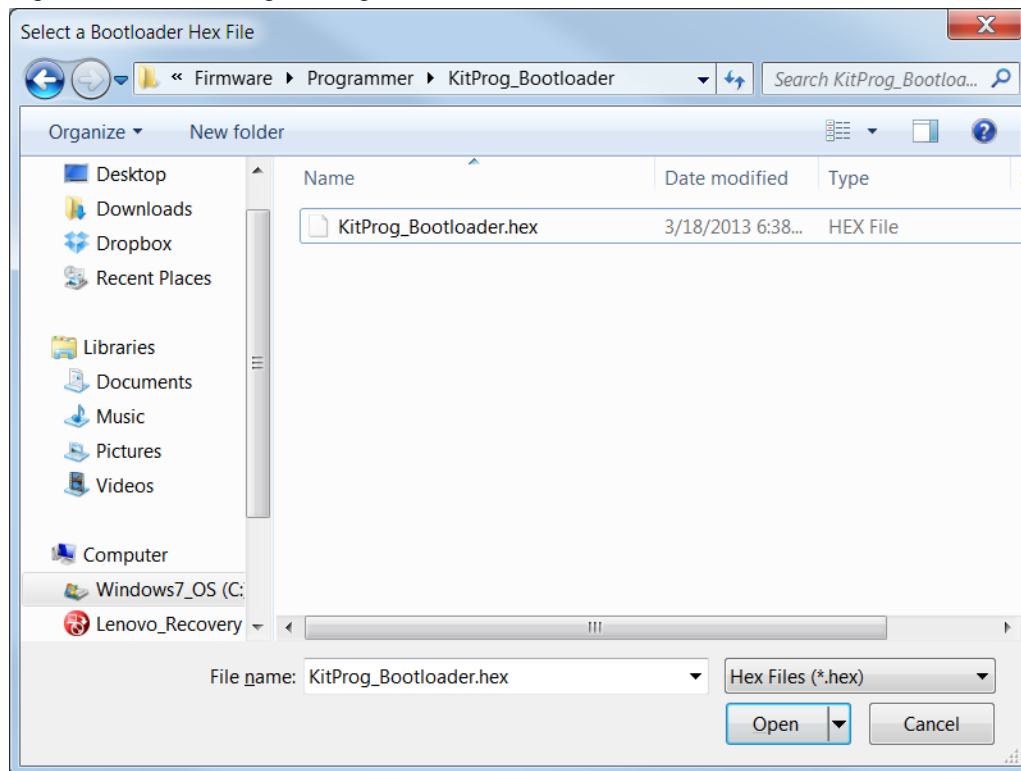
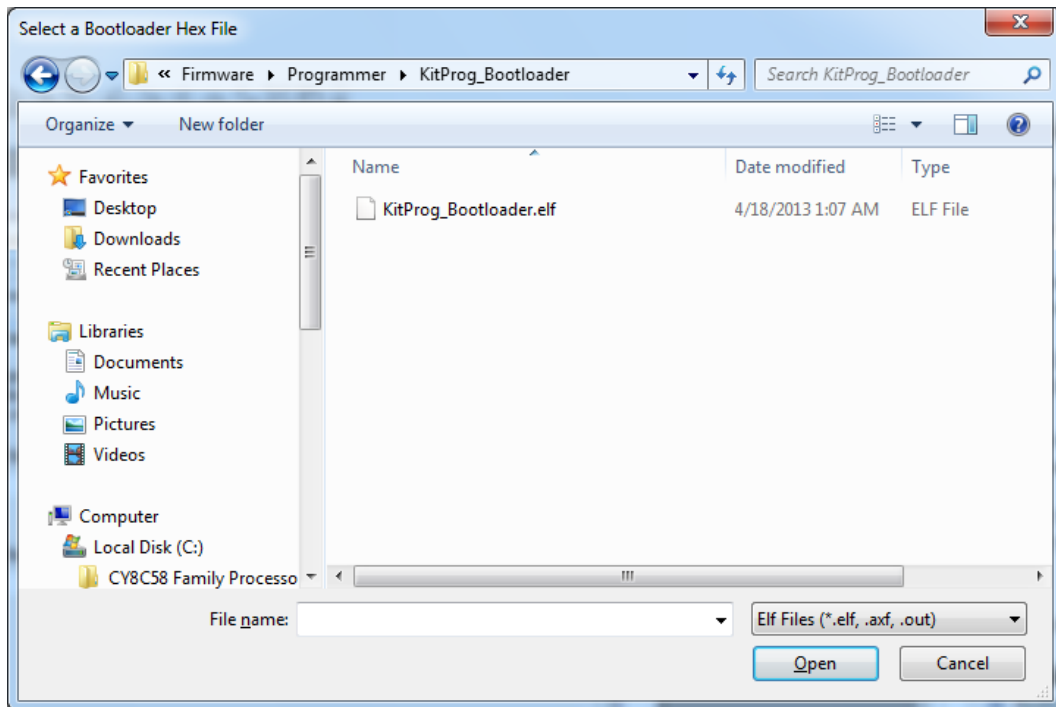
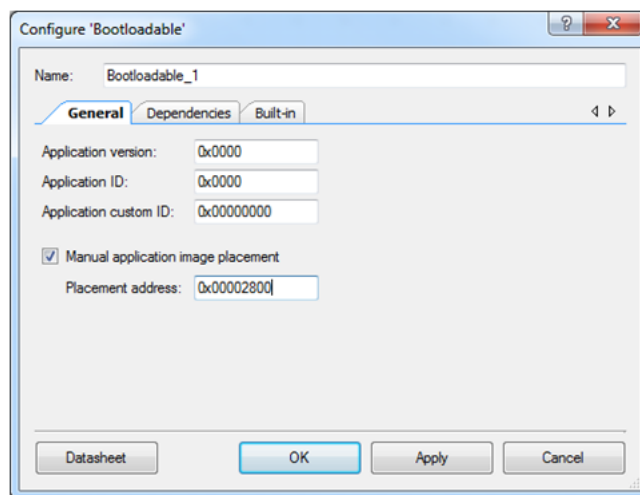

Figure 6-38. Selecting KitProg Bootloader Elf File



3. In the **General** tab, check the **Manual application image placement** checkbox and set the **Placement address** as “0x00002800” as shown in [Figure 6-39](#).

Figure 6-39. Bootloadable Component-General Tab



4. Develop your custom project.

- The NVL setting of the Bootloadable project and the KitProg\_Bootloader project must be the same. The *KitProg\_Bootloader.cydwr* system settings is shown in the following figure.

Figure 6-40. KitProg Bootloader System Settings

Option	Value
Configuration	
Device Configuration Mode	Compressed
Enable Error Correcting Code (ECC)	<input type="checkbox"/>
Store Configuration Data in ECC Memory	<input type="checkbox"/>
Instruction Cache Enabled	<input checked="" type="checkbox"/>
Enable Fast IMO During Startup	<input checked="" type="checkbox"/>
Unused Bonded IO	Allow with info
Heap Size (bytes)	0x1000
Stack Size (bytes)	0x4000
Include CMSIS Core Peripheral Library Files	<input checked="" type="checkbox"/>
Programming/Debugging	
Debug Select	GPIO
Enable Device Protection	<input type="checkbox"/>
Embedded Trace (ETM)	<input type="checkbox"/>
Use Optional XRES	<input type="checkbox"/>
Operating Conditions	
VDDA (V)	5.0
Variable VDDA	<input type="checkbox"/>
VDDD (V)	5.0
VDDIO0 (V)	5.0
VDDIO1 (V)	5.0
VDDIO2 (V)	5.0
VDDIO3 (V)	5.0
Temperature Range	-40C - 85/125C

Set the Port 1 preferred program/debug interface (UTAG or SWD or SWD+SWV) that the chip enables by default for use after power up or reset. Setting to GPIO frees the pins for use as GPIOs but does not completely disable the debug interface for flash protection purposes. "Enable Device Protection" must be set for this purpose. For more information about programming and debugging options see the device data sheet or Technical Reference Manual (TRM).

- Build the project in PSoC Creator by selecting **Build > Build Project** or **[Shift]+[F6]**.
- To download the project on to the PSoC 5LP device, open the Bootloader Host Tool, which is available from PSoC Creator. Select **Tools > Bootloader Host**.

Figure 6-41. Opening Bootloader Host Tool from PSoC Creator

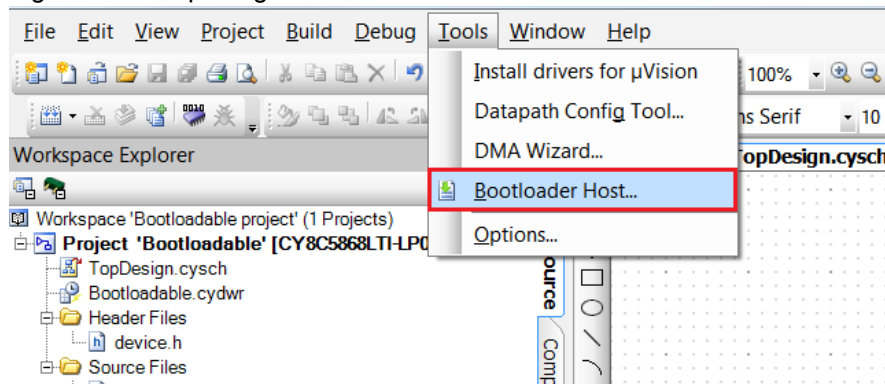

- Keep the reset switch (SW1) pressed and plug in the USB Mini-B connector. If the switch is pressed for more than 100 ms, the PSoC 5LP enters into bootloader. The PSoC 5LP also enters into bootloader when the power supply jumper for the PSoC 4 (J13) is removed and subsequently the USB Mini-B connector is plugged into header J10.

- In the Bootloader Host tool, click **Filters** and add a filter to identify the USB device. Set VID as **0x04B4**, PID as **0xF13B**, and click **OK**.

Figure 6-42. Port Filters Tab in Bootloader Host Tool

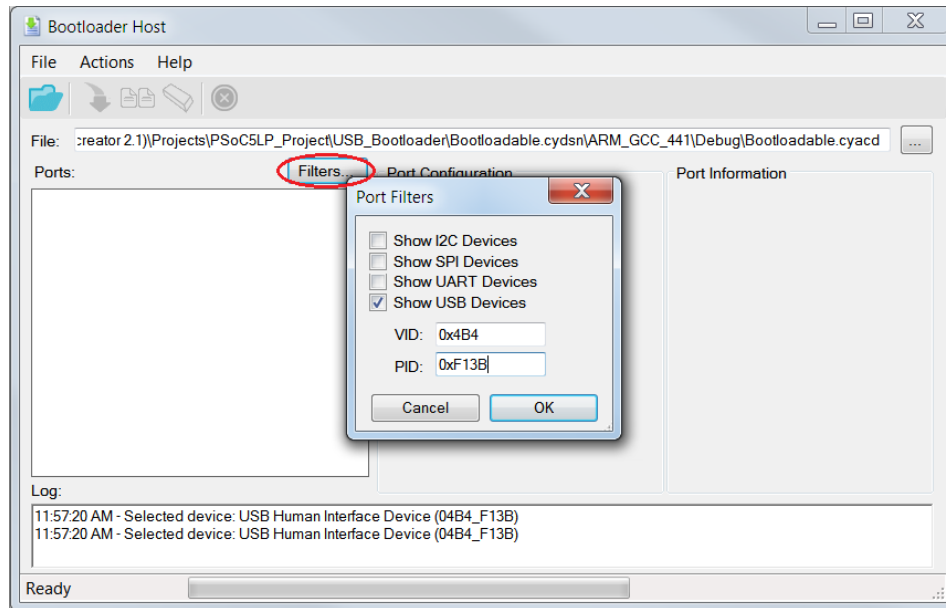

- In the Bootloader Host tool, click the **Open File** button to browse to the location of the bootloadable file (\*.cyacd).

Figure 6-43. Opening Bootloadable File from Bootloader Host Tool

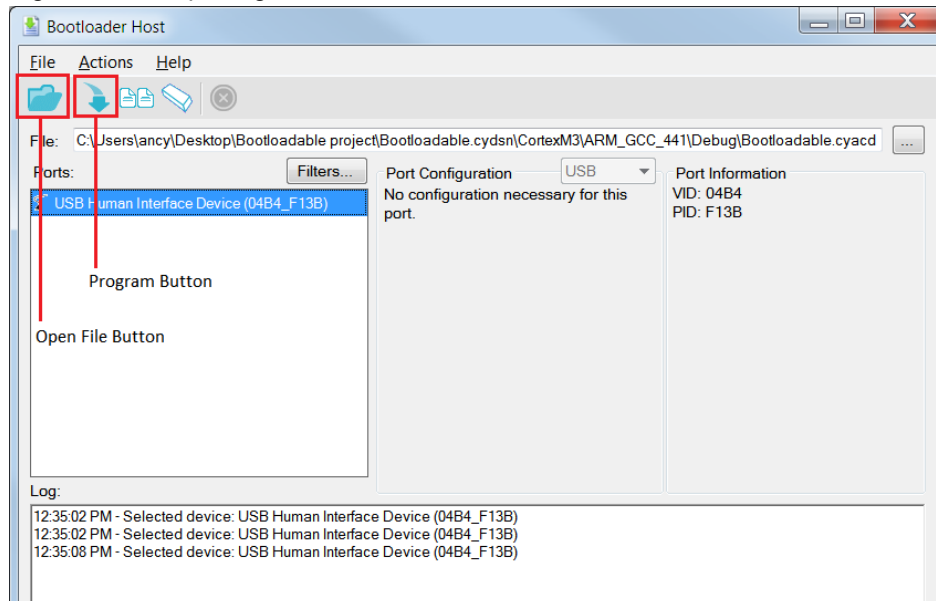

11. Press the **Program** button in the Bootloader Host tool to program the device.

Figure 6-44. Selecting Bootloadable .cyacd File from Bootloader Host

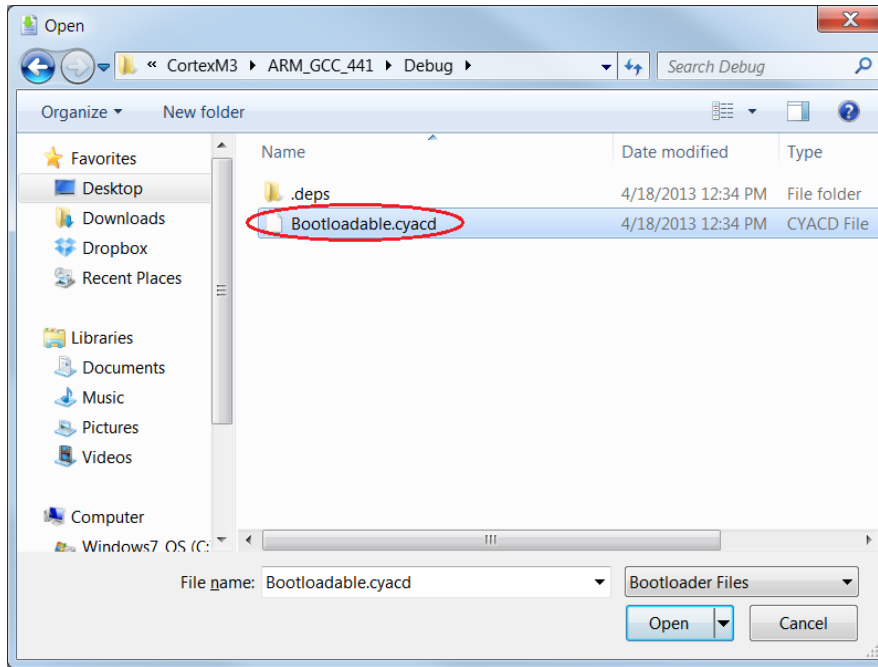

12. If bootload is successful, the log of the tool displays "Successful"; otherwise, it displays "Failed" and a statement for the failure.

**Notes:**

1. The PSoC 5LP pins are brought to the PSoC 5LP GPIO header (J8). These pins are selected to support high-performance analog and digital projects. See [A.2 Pin Assignment Table on page 116](#) for pin information.
2. Take care when allocating the PSoC 5LP pins for custom applications. For example, P2[0]–P2[4] are dedicated for programming the PSoC 4. Refer to [A.1 CY8CKIT-042 Schematics on page 113](#) before allocating the pins.
3. When a normal project is programmed onto the PSoC 5LP, the initial capability of the PSoC 5LP to act as a programmer, USB-UART bridge, or USB-I2C bridge is not available.
4. The status LED does not function unless used by the custom project.

For additional information on bootloaders, refer to Cypress application note, [AN73503 - USB HID Bootloader for PSoC 3 and PSoC 5LP](#).

### 6.3.2 Building a Normal Project for PSoC 5LP

A normal project is a completely new project created for the PSoC 5LP device on the CY8CKIT-042. Here the entire flash of the PSoC 5LP is programmed, overwriting all bootloader and programming code. To recover the programmer, reprogram the PSoC 5LP device with the factory-set *KitProg.hex* file, which is shipped with the kit installer.

The *KitProg.hex* file is available at the following location:

```
<Install_Directory>\CY8CKIT-042 PSoC 4 Pioneer Kit\<version>\Firm-  
ware\Programmer\KitProg
```

This advanced functionality requires a MiniProg3 programmer, which is not included with this kit. The MiniProg3 can be purchased from [www.cypress.com/go/CY8CKit-002](http://www.cypress.com/go/CY8CKit-002).

To build a normal project for the PSoC 5LP, follow these steps:

1. In PSoC Creator, choose **New > Project** and click **PSoC 5LP Design**; select **Device as CY8C5868LTI-LP039** (see [Figure 6-45](#)), and then click **OK**.

Figure 6-45. Opening New Project in PSoC Creator

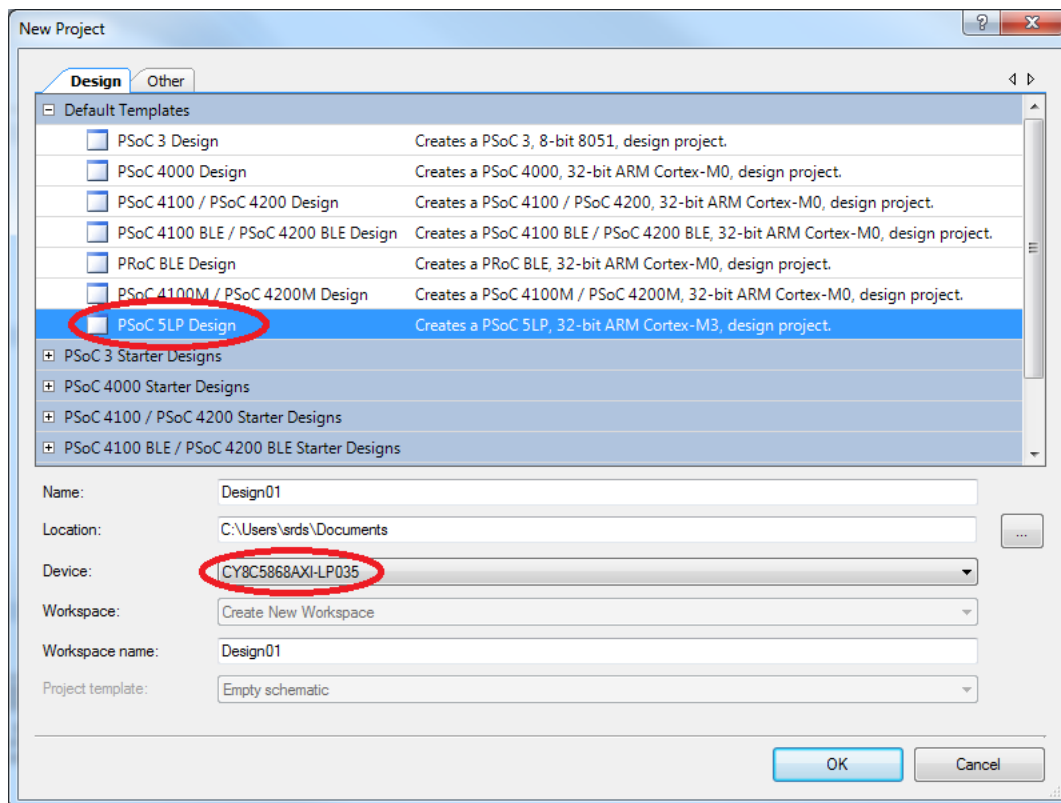

2. Develop your custom project.
3. Build the project in PSoC Creator by selecting **Build > Build Project** or **[Shift]+[F6]**.
4. Connect the 10-pin connector of MiniProg3 to the onboard 10-pin SWD debug and programming header J7 (which needs to be populated).
5. To program the PSoC 5LP with PSoC Creator, click **Debug > Program** or **[Ctrl]+[F5]**. The Programming window shows MiniProg3 and the selected device in the project under it (CY8C5868LTI-LP039).
6. Click on the device and click **Connect** to program.



**Notes:**

1. The 10-pin SWD debug and programming header (J7) is not populated. See the 'No Load Components' section of [A.6 Bill of Materials \(BOM\)](#) for details.
2. The PSoC 5LP pins are brought to the PSoC 5LP GPIO header (J8). These pins are selected to support high-performance analog and digital projects. See [A.2 Pin Assignment Table](#) for pin information.
3. Take care when allocating the PSoC 5LP pins for custom applications. For example, P2[0]–P2[4] are dedicated for programming the PSoC 4. Refer to [A.1 CY8CKIT-042 Schematics](#) before allocating the pins.
4. When a normal project is programmed onto the PSoC 5LP, the initial capability of the PSoC 5LP to act as a programmer, USB-UART bridge, or USB-I2C bridge is not available.
5. The status LED does not function unless used by the custom project.

## 6.4 PSoC 5LP Factory Program Restore Instructions

The CY8CKIT-042 PSoC 4 Pioneer Kit features a PSoC 5LP device that comes factory-programmed as the onboard programmer and debugger for the PSoC 4 device.

In addition to creating applications for the PSoC 4 device, you can also create custom applications for the PSoC 5LP device on this kit. For details, see section [6.3 Developing Applications for PSoC 5LP on page 88](#). Reprogramming or bootloading the PSoC 5LP device with a new flash image will overwrite the factory program and forfeit the ability to use the PSoC 5LP device as a programmer/debugger for the PSoC 4 device. Follow the instructions to restore the factory program on the PSoC 5LP and enable the programmer/debugger functionality.

### 6.4.1 PSoC 5LP is Programmed with a Bootloadable Application

If the PSoC 5LP is programmed with a bootloadable application, restore the factory program by using one of the following two methods.

#### 6.4.1.1 *Restore PSoC 5LP Factory Program Using PSoC Programmer*

1. Launch **PSoC Programmer 3.23.1** or later from **Start > Cypress > PSoC Programmer**.
2. Configure the Pioneer Kit in Service Mode. To do this, while holding down the reset button (SW1 Reset), plug in the PSoC 4 Pioneer Kit to the computer using the included USB cable (USB A to mini-B). This puts the PSoC 5LP into service mode, which is indicated by the blinking green status LED.

- The following message appears in the PSoC Programmer results window “KitProg Bootloader device is detected”.

Figure 6-46. PSoC Programmer Results Window

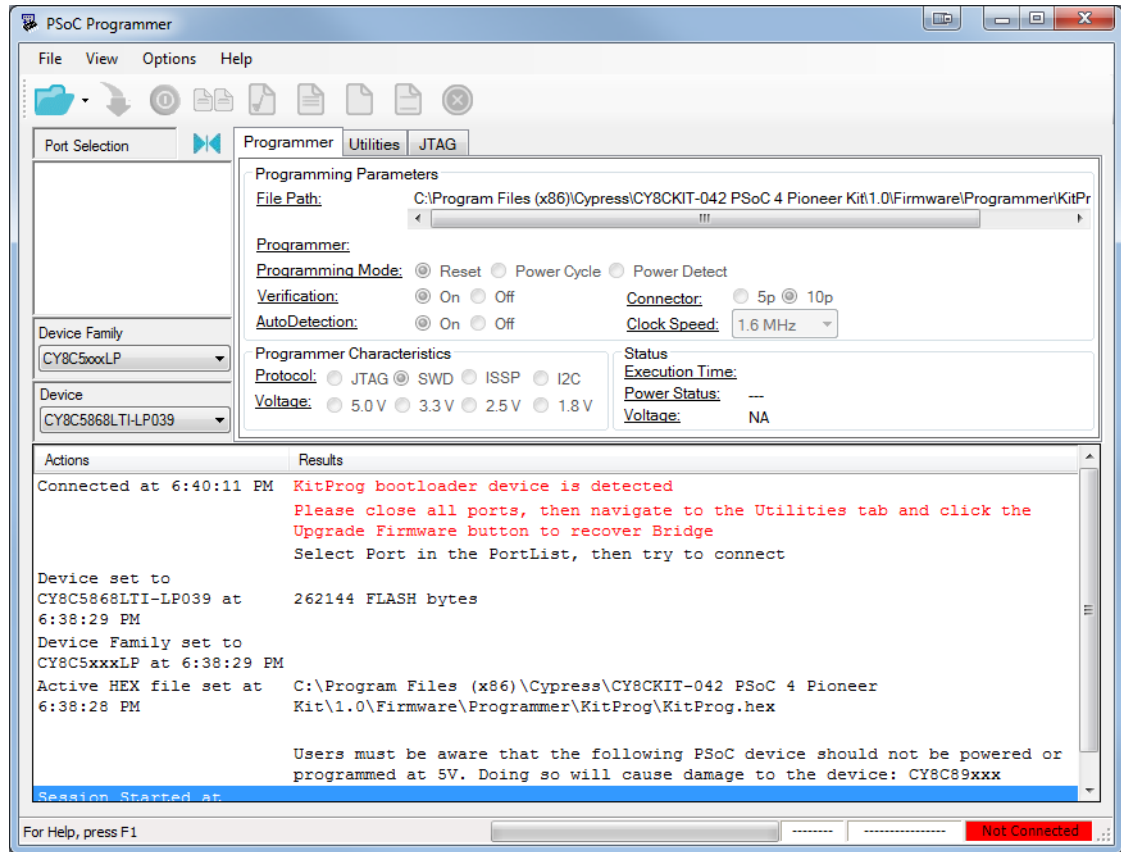

- Switch to the **Utilities** tab in PSoC Programmer and press the **Upgrade Firmware** button. Unplug all other PSoC programmers (such as MiniProg3 and DVKProg) from the PC before pressing the **Upgrade Firmware** button.

Figure 6-47. Upgrade Firmware

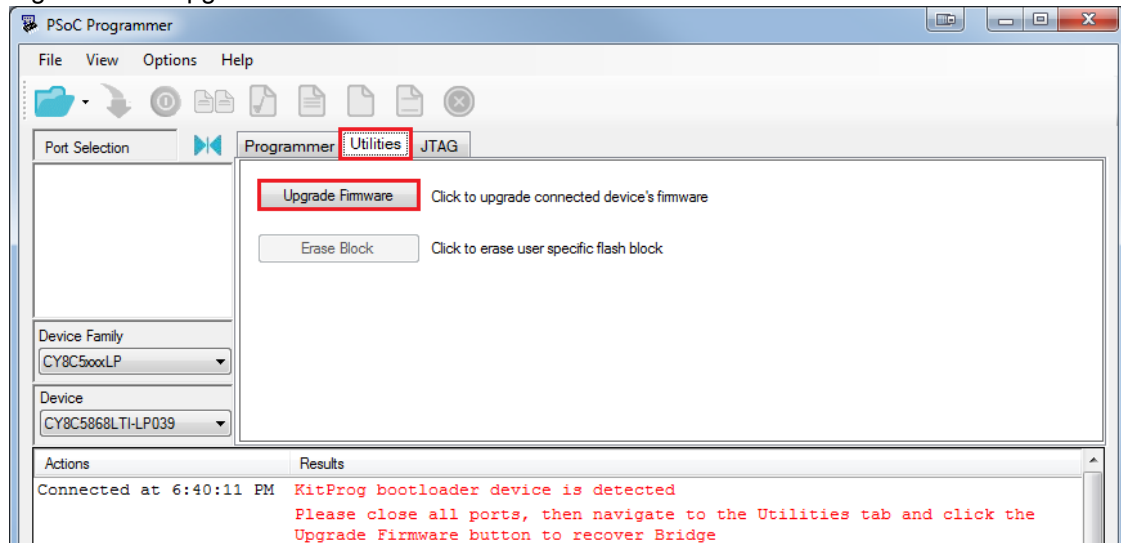

- After programming has completed, the following message appears: “Firmware Update Finished at <time>”.

Figure 6-48. Firmware Update Complete

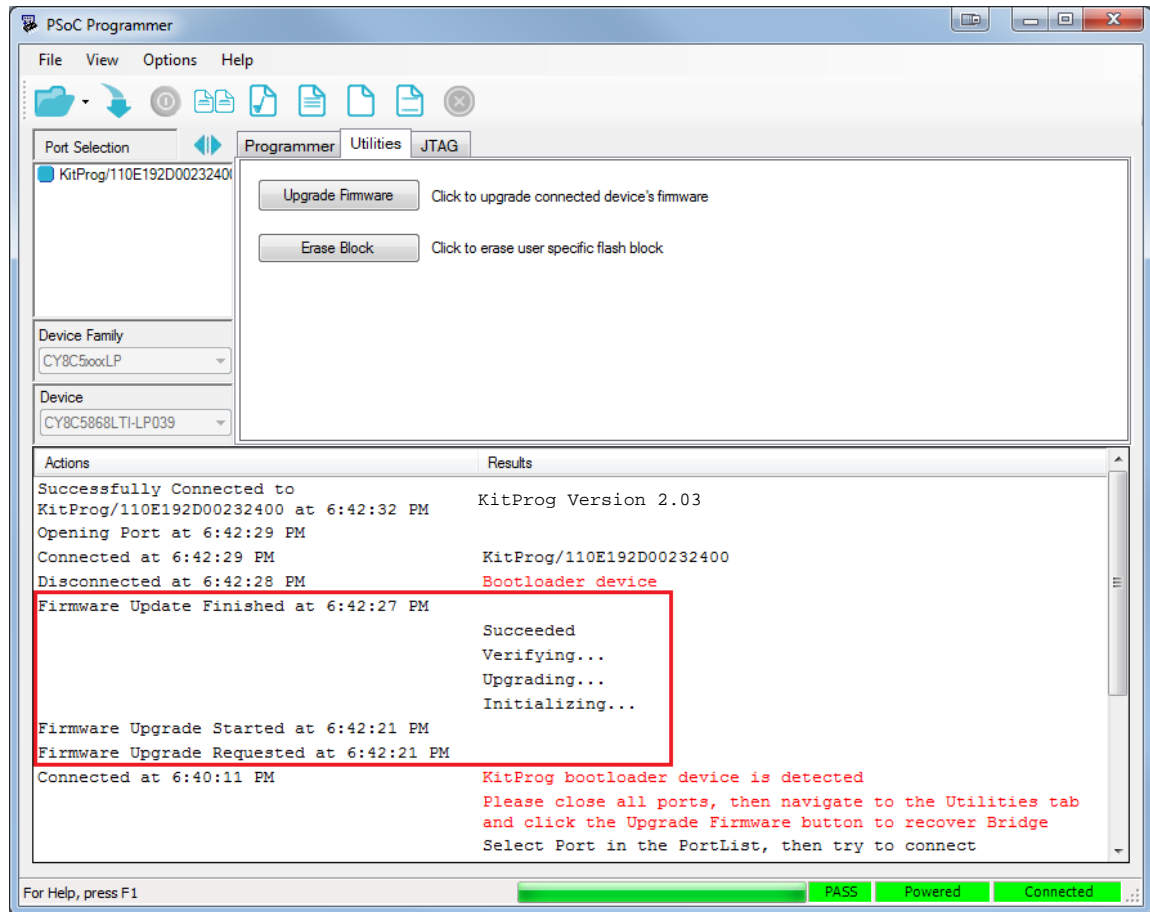

- The factory program is now successfully restored on the PSoC 5LP. It can be used as the programmer/debugger for the PSoC 4 device.

### 6.4.1.2 Restore PSoC 5LP Factory Program Using USB Host Tool

1. Launch the Bootloader Host tool from **Start > Cypress > PSoC Creator**.
2. Using the **File > Open** menu, load the *Kit Prog.cyacd* file, which is installed with the kit software. The default location for this file is: <Install\_Directory>\CY8CKIT-042 PSoC 4 Pioneer Kit\<version>\Firmware\Programmer\KitProg\KitProg.cyacd

Figure 6-49. Load KitProg.cyacd File

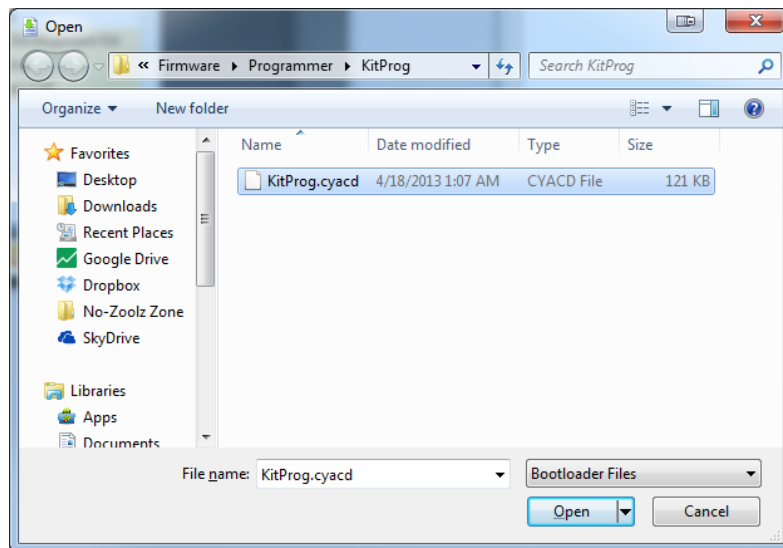
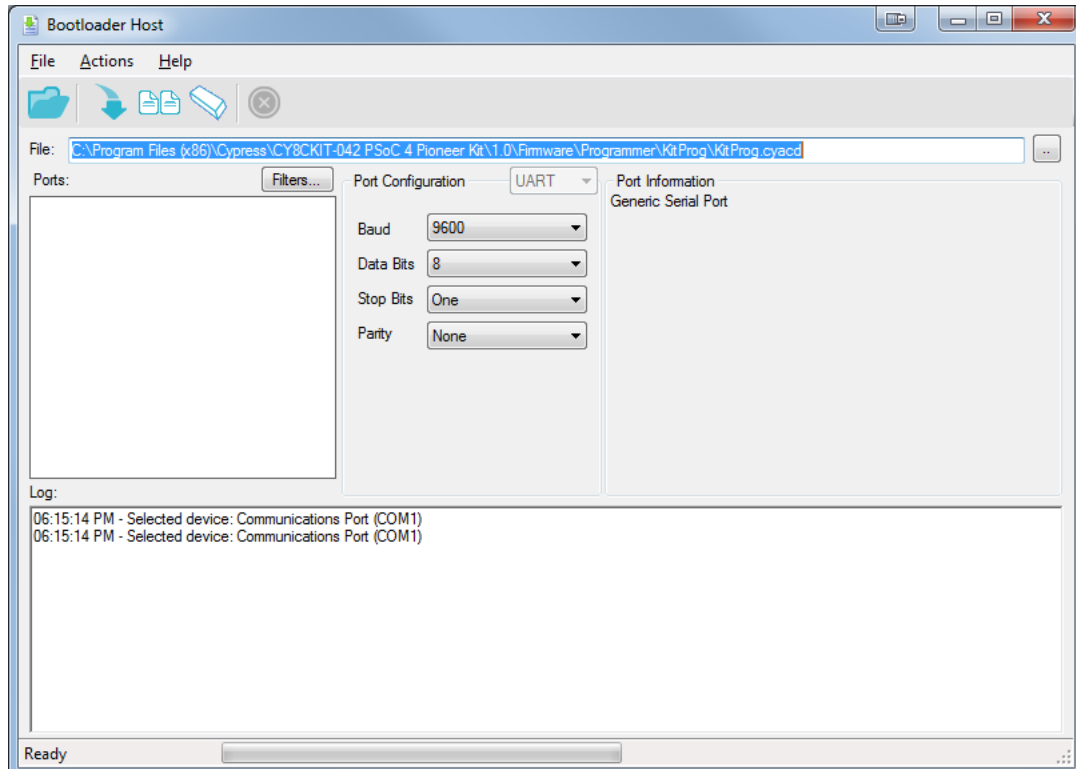

3. Configure the Pioneer Kit in Service Mode. To do this, while holding down the reset button (SW1 Reset), plug in the PSoC 4 Pioneer Kit to the computer using the included USB cable (USB A to mini-B). This puts the PSoC 5LP into service mode, which is indicated by the blinking green status LED.
4. In the Bootloader Host tool, set the filters for the USB devices with VID: 04B4 and PID: F13B. **USB Human Interface Device** port appears in the Ports list. Click that port to select it.

Figure 6-50. Select USB Human Interface Device

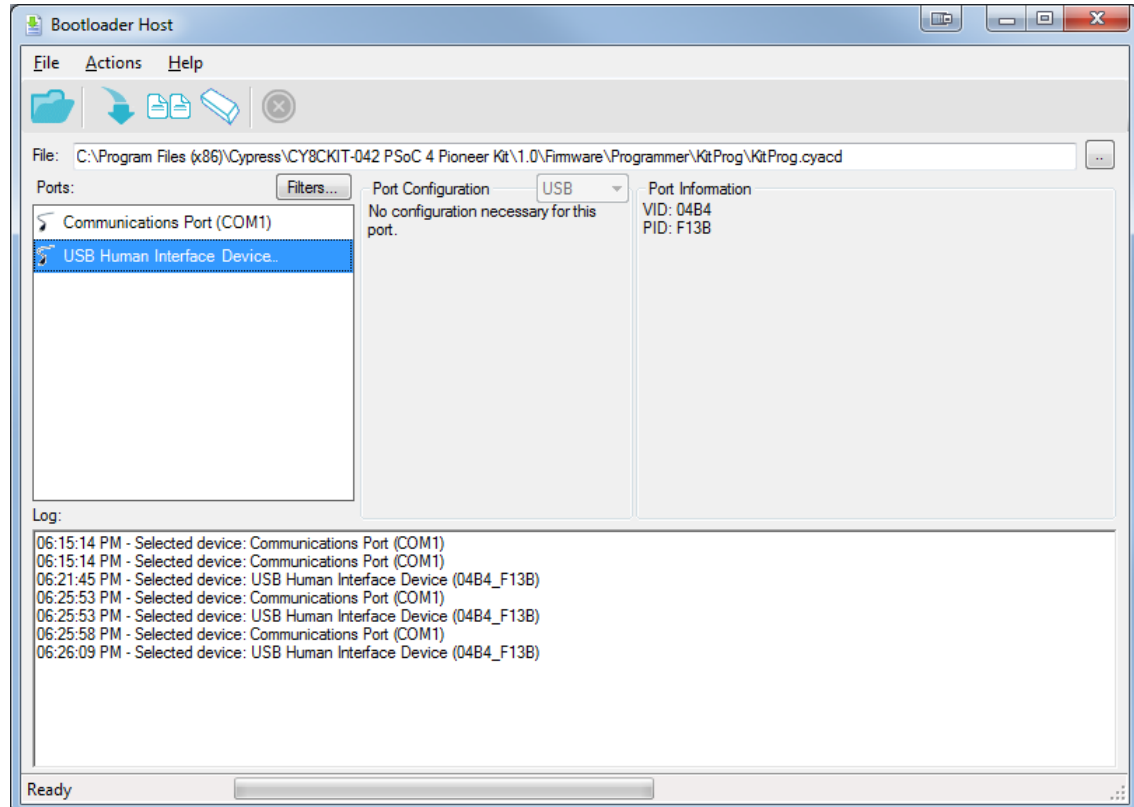

5. Click the **Program** button (or menu item **Actions > Program**) to restore the factory-program by bootloading it onto the PSoC 5LP.
6. After programming has completed, the following message appears: “Programming Finished Successfully”.

Figure 6-51. Programming Finished Successfully

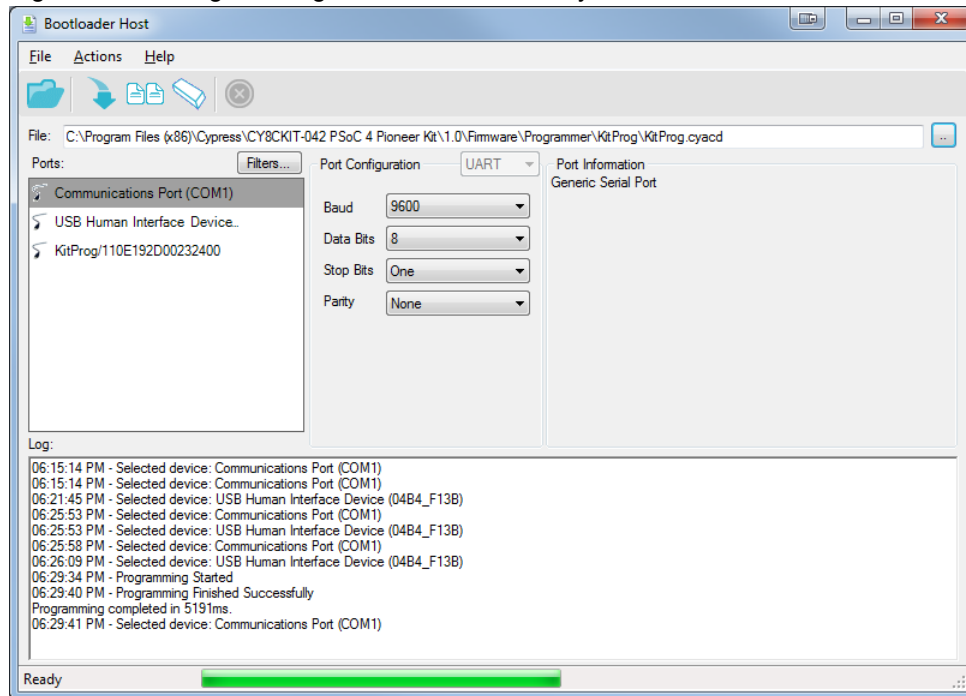

7. The factory program is now successfully restored on the PSoC 5LP. It can be used as the programmer/debugger for the PSoC 4 device.

#### 6.4.2 PSoC 5LP is Programmed with a Standard Application

If PSoC 5LP is programmed with a standard application, restore the factory program by using the following method.

1. Launch **PSoC Programmer 3.23.1** or later from **Start > Cypress > PSoC Programmer**.
2. Use the **File > Open** menu to load the *KitProg.hex* factory program hex file, which is shipped with the kit. The default location for this file is: <Install\_Directory>\CY8CKIT-042 PSoC 4 Pioneer Kit\<version>\Firmware\Programmer\KitProg
3. Connect a **CY8CKIT-002 MiniProg3** (sold separately) to the computer. The 10-pin connector cable on the MiniProg3 plugs into the header [J7]. Note that the J7 header is unpopulated. For more details, see [A.6 Bill of Materials \(BOM\) on page 121](#).

4. Ensure that **MiniProg3** is the selected port in PSoC Programmer and the 10-pin connector (**10p** option) is selected, as shown in the following figure. If the board is not powered over USB, select the **Power Cycle** programming mode.

Figure 6-52. Select MiniProg3

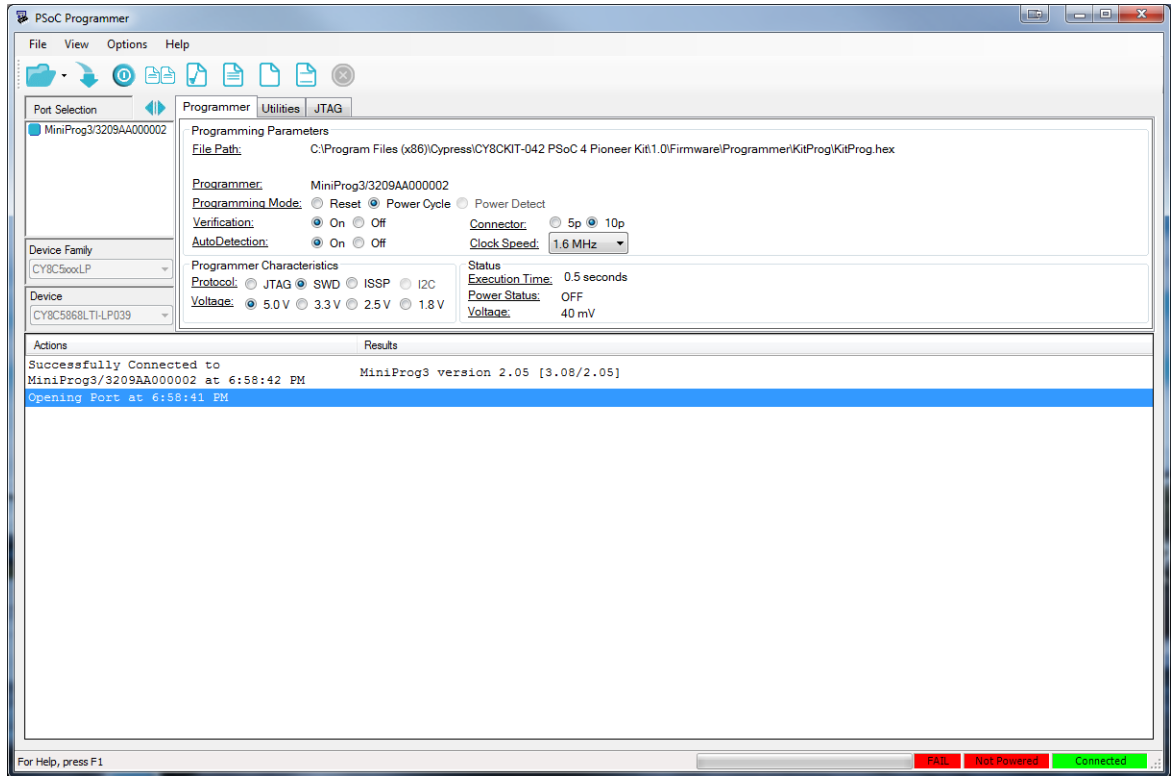

5. When ready, press the **Program** button (or **File > Program**) to program the PSoC 5LP device.

- After programming has completed, the following message appears: “Program Finished at <time>”.

Figure 6-53. Program Finished

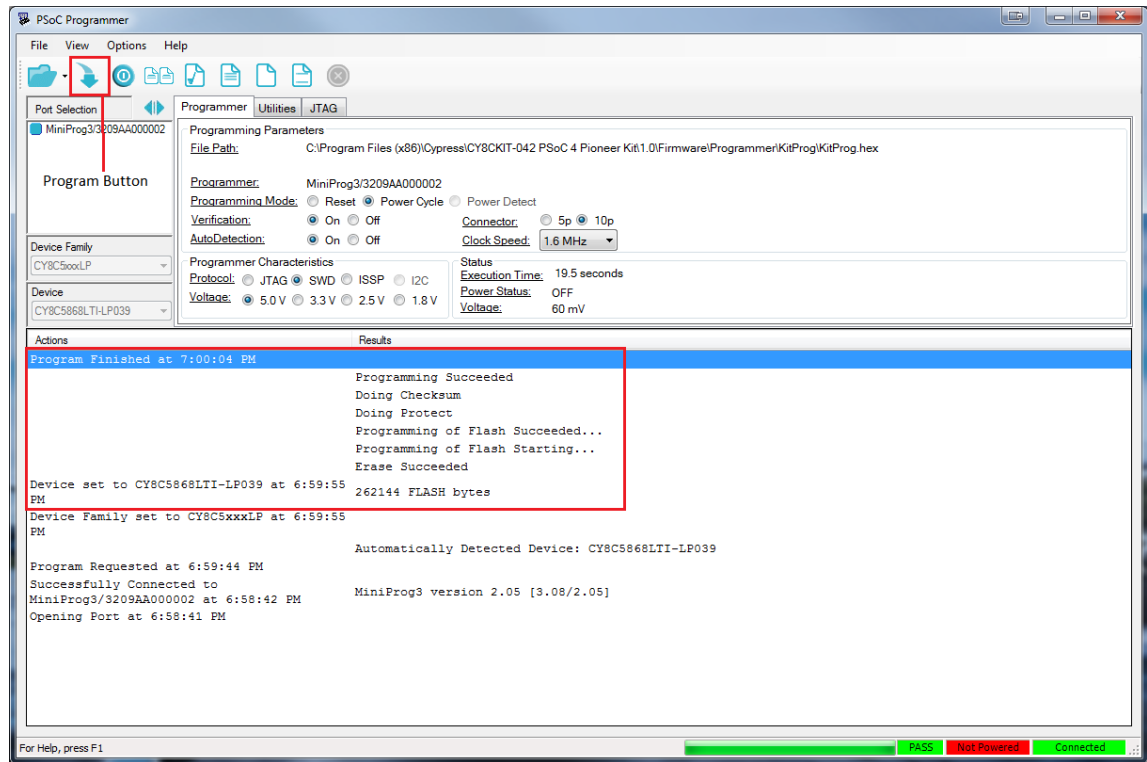

- The factory program is now successfully restored on the PSoC 5LP. It can be used as the programmer/debugger for the PSoC 4 device.

## 6.5 Using $\mu$ C/Probe Tool

Micrium’s  $\mu$ C/probe is a windows application that allows you to read and write the memory of any embedded target processor during run-time, and map those values to a set of virtual controls and indicators placed on a graphical dashboard.

This tool helps in designing a simple GUI for the example projects of the development kits with least effort.

Please note that Micrium  $\mu$ C/Probe tool is not pre-requisite software required to run this kit and does not get installed along with kit contents.

The license required to use all the features of the tool need to be purchased separately by the user. However, the educational edition of the tool is available as a free download from <http://micrium.com/download/ucprobe-3-0-trial-version/>.

The Educational Edition of  $\mu$ C/Probe is available for free to enable you to “try before you buy”. For more details on licensing and the  $\mu$ C/Probe tool, please refer to the  $\mu$ C/Probe Users’ Manual at <http://micrium.com/download/%c2%b5cprobe-3-0-users-manual/>.

In Micrium  $\mu$ C/Probe version 3.3, the Cypress KitProg is being supported as a means of communication to the target device connected to PC.



When an example project is built in PSoC Creator, it produces the output files in HEX, LST, MAP, RPT and ELF formats.

The ELF file lists all the symbols (variables), symbol types and its addresses. The Micrium  $\mu$ C/Probe tool reads the ELF file and detects these symbols (global variables) used in the code.

The  $\mu$ C/Probe tool provides a host of graphical controls such as sliders, RGB palette, graphs, donuts etc. The controls required can be dragged and dropped onto  $\mu$ C/Probe workbench and symbols from ELF file can be assigned to the controls.

When the workbench is run, the changes in symbol value associated with the controls (slider, graph etc) can be visualized on the PC.

Appropriate global variables have been assigned in CapSense and PWM example projects of the kit to visualize the CapSense output and PWM output on a GUI.

**Note:** The ELF file is generated by the PSoC Creator and gets removed during the project Clean process. So, to use any of the WSPX files, please ensure to build the project so that ELF file gets generated. Else, the  $\mu$ C/Probe tool pops-up a message the ELF file is missing.

### 6.5.1 CapSense Example Project

To visualize the output of CapSense project using  $\mu$ C/Probe tool, follow the steps given below:

1. Program the CapSense example project on CY8CKIT-042 by following steps 1–8 in chapter 5.
2. Download and install  $\mu$ C/Probe tool from <http://micrium.com/download/mucprobe-3-0-trial-version/>.
3. Launch  $\mu$ C/Probe from **Start > All Programs > Micrium > uC-Probe > Micrium uC-Probe**.

Figure 6-54. Micrium  $\mu$ C/Probe

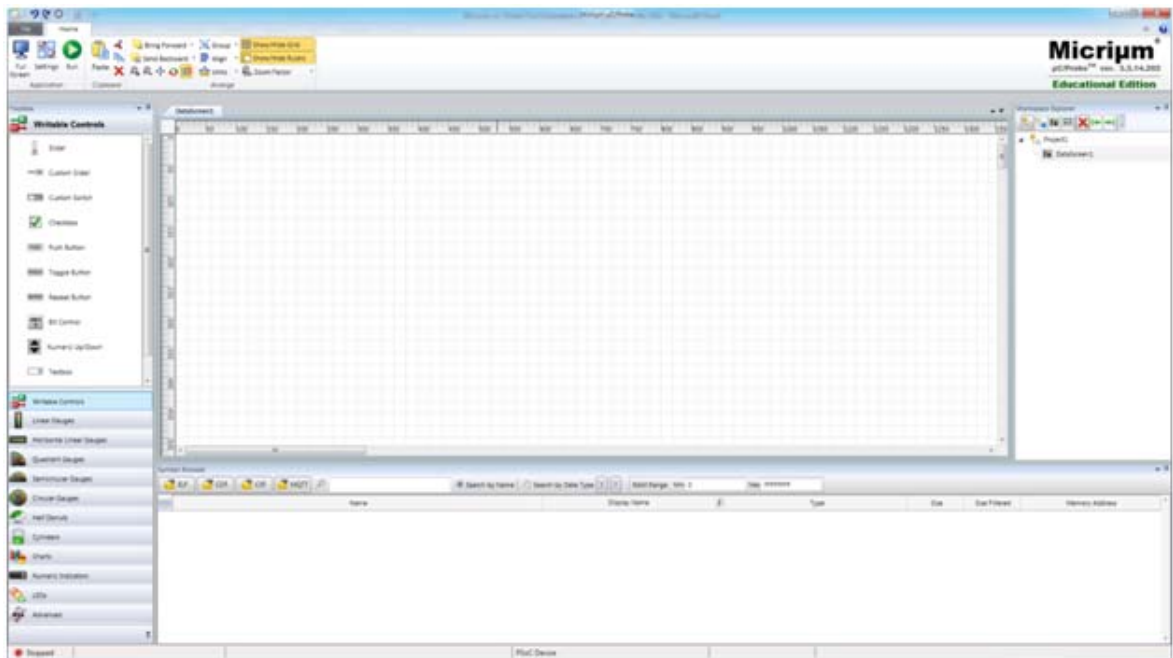

4. Drag and drop a Custom Slider control from Writable Controls in Toolbox on to the Datascreen1.  
Figure 6-55. Adding Slider Control

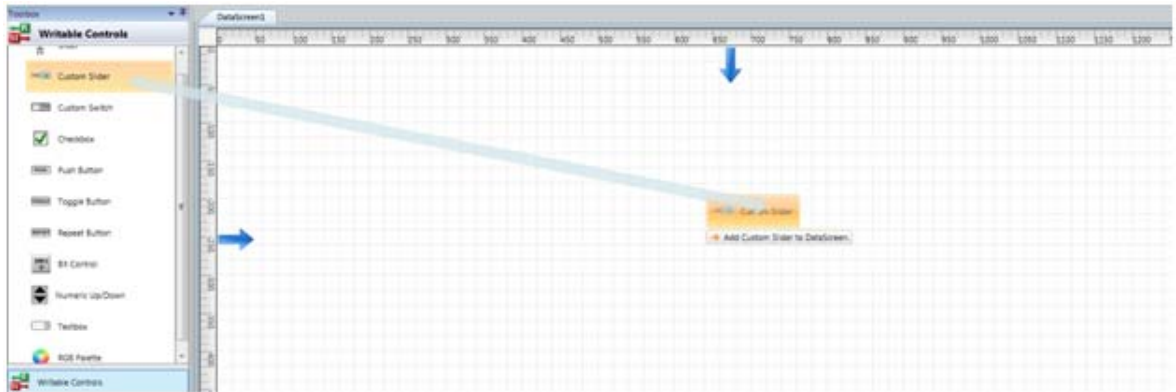

5. Next, add a RGB Palette from Writable Controls in Toolbox on to the Datascreen1.  
Figure 6-56. Adding RGB Palette Control

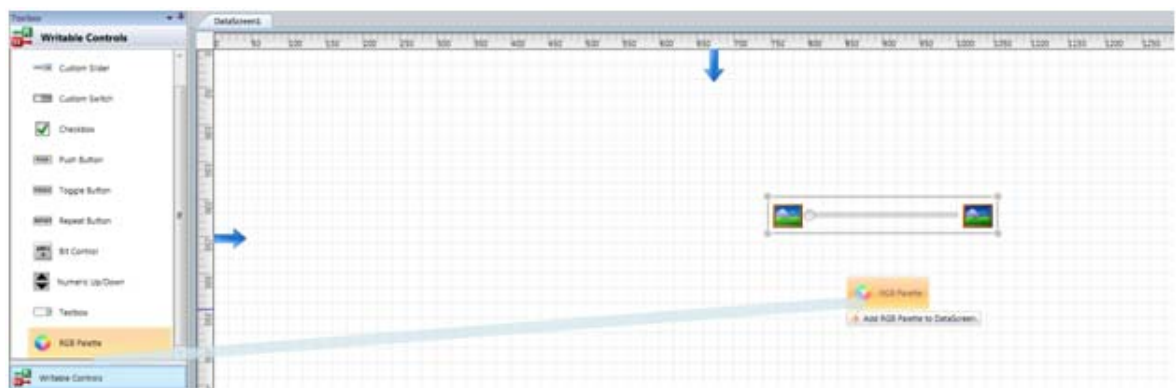

6. The DataScreen1 looks as below after adding both the controls.  
Figure 6-57. DataScreen with Slider and RGB controls

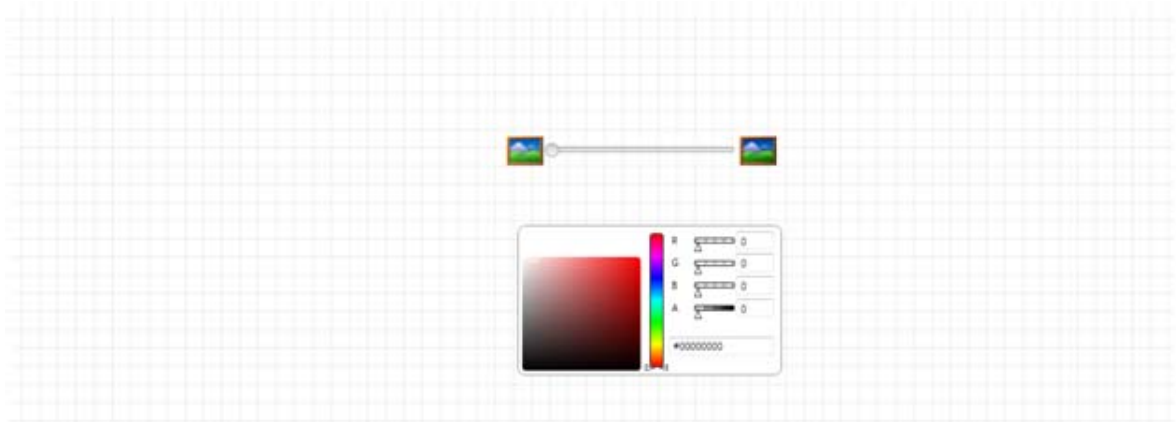

7. Now, click on the ELF button in the Symbol Browser window.

Figure 6-58. ELF button in Symbol Browser

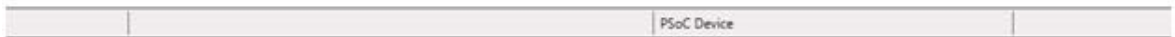

8. Browse and point to the CapSense.ELF file to load the symbols (global variables) from the CapSense example project. Wait until the ELF file gets loaded. The elf file is in the collapsed state by default. It can be expanded by clicking on the '+' button next to the file name.
9. On expanding the elf file, it can be seen that the Symbol Browser displays all the .C files in the example project. By expanding each file, the global variables defined in that C file are displayed with its name, type, size, memory address etc.
10. Now, expand the main.c file to view the global variables defined in main.c file.

Figure 6-59. Global variables in Symbol Browser

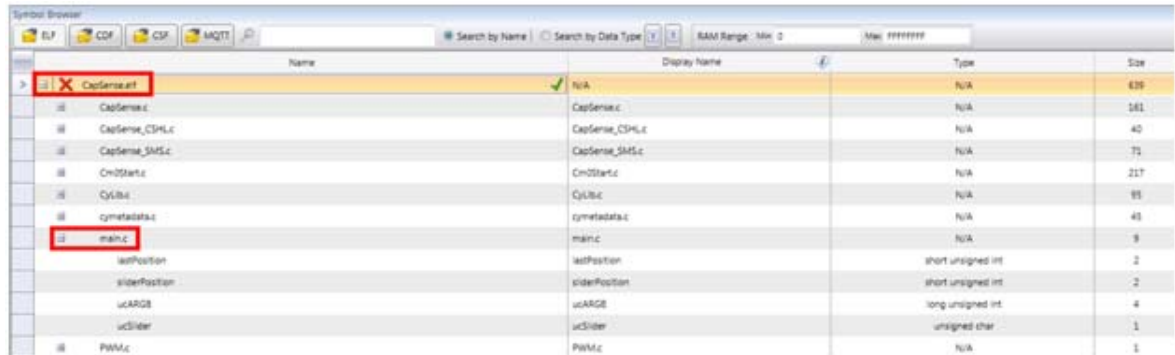

11. Drag and drop the global variable `ucSlider` on to the custom slider control to see the slider output. Similarly, drag and drop the global variable `ucARGB` on to the RGB Palette to see the RGB output.

Figure 6-60. Assigning slider output to Custom Slider control

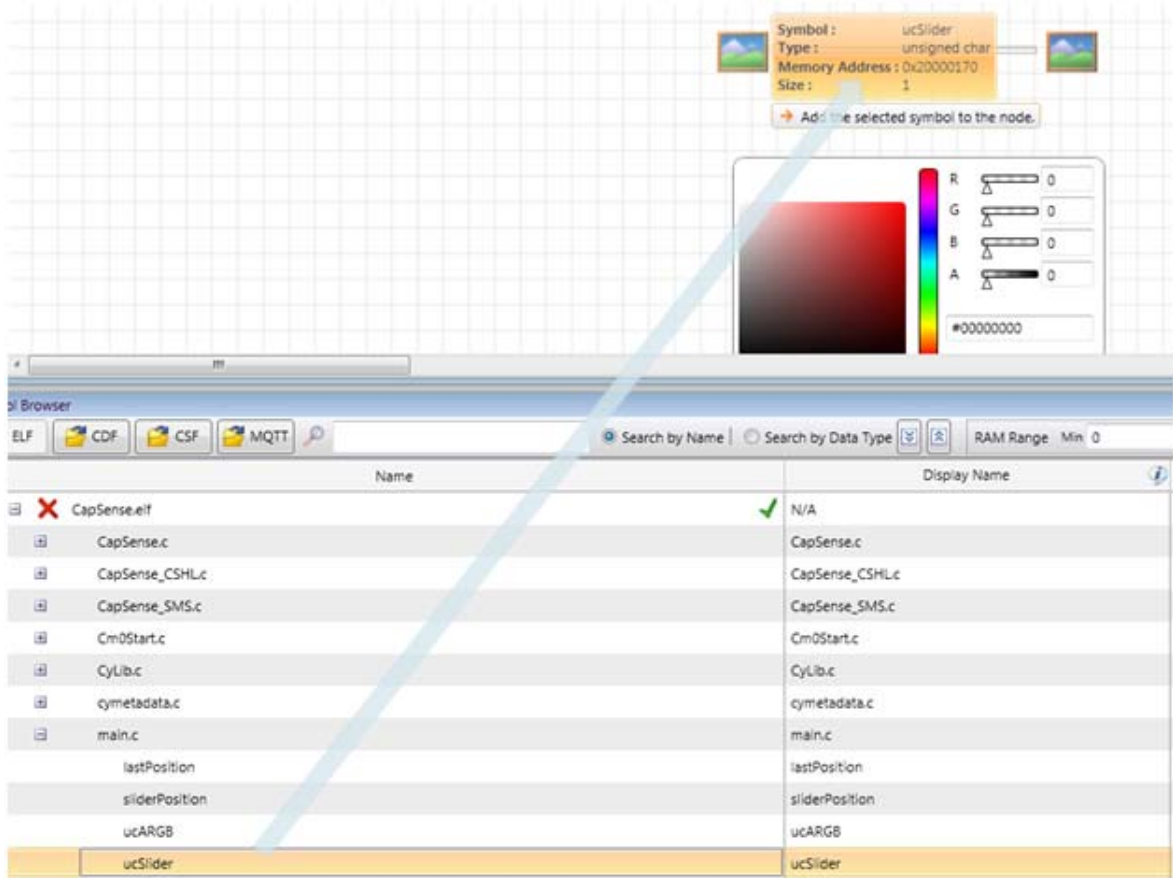
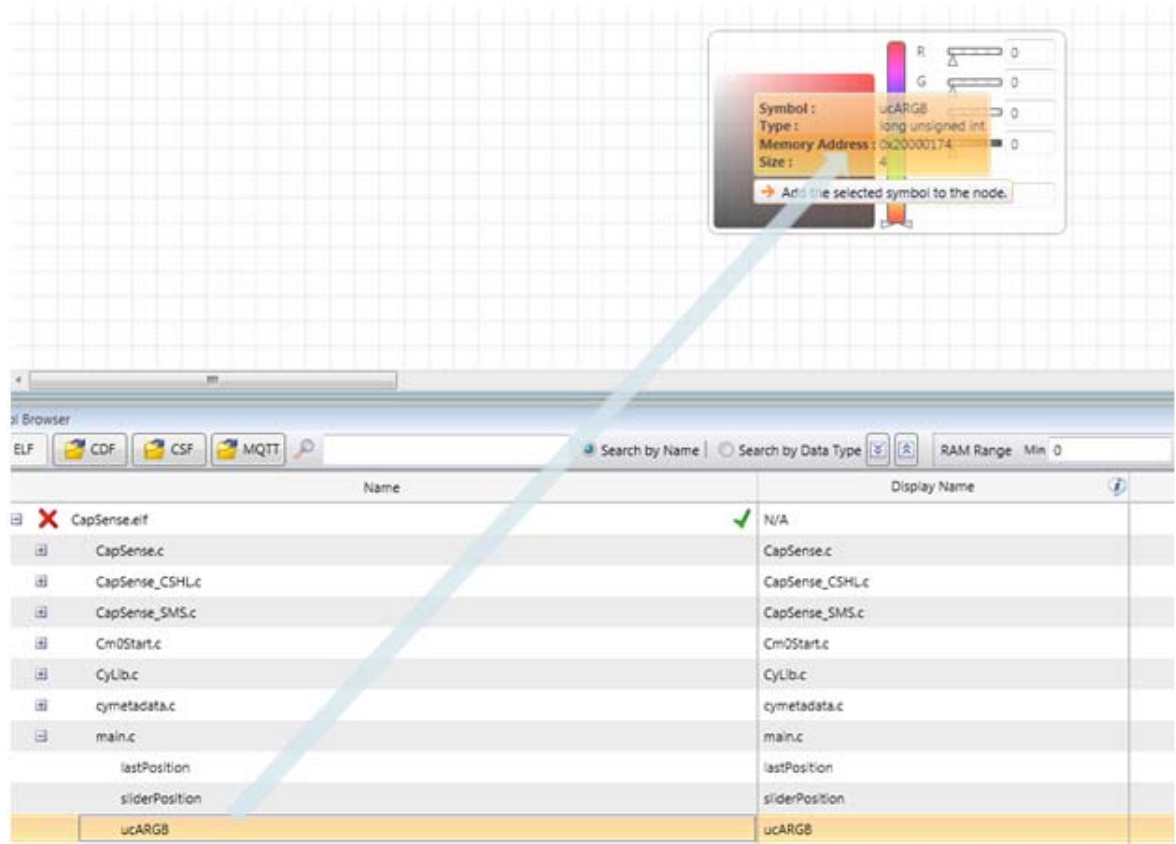
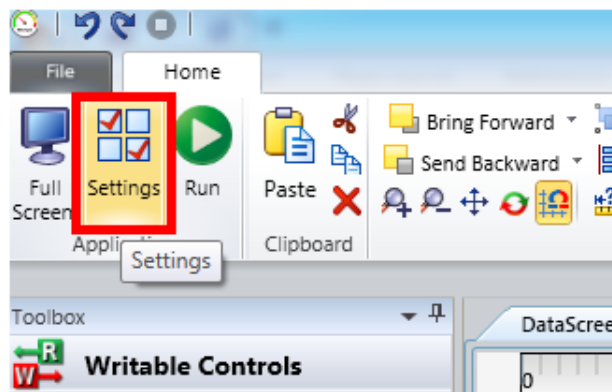

Figure 6-61. Assigning RGB output to RGB Palette control



12. Now, connect the CY8CKIT-042 to PC. Click on the Settings button in the  $\mu$ C/Probe tool.

Figure 6-62. Settings button in  $\mu$ C/Probe



13. In the  $\mu$ C/Probe setting window, select the Cypress PSoC Prog and select 'KitProg/<Kit Prog number>' from the drop down box for Port and click **OK** to start communication between the CY8CKIT-042 and the  $\mu$ C/Probe tool.

Figure 6-63.  $\mu$ C/Probe Settings

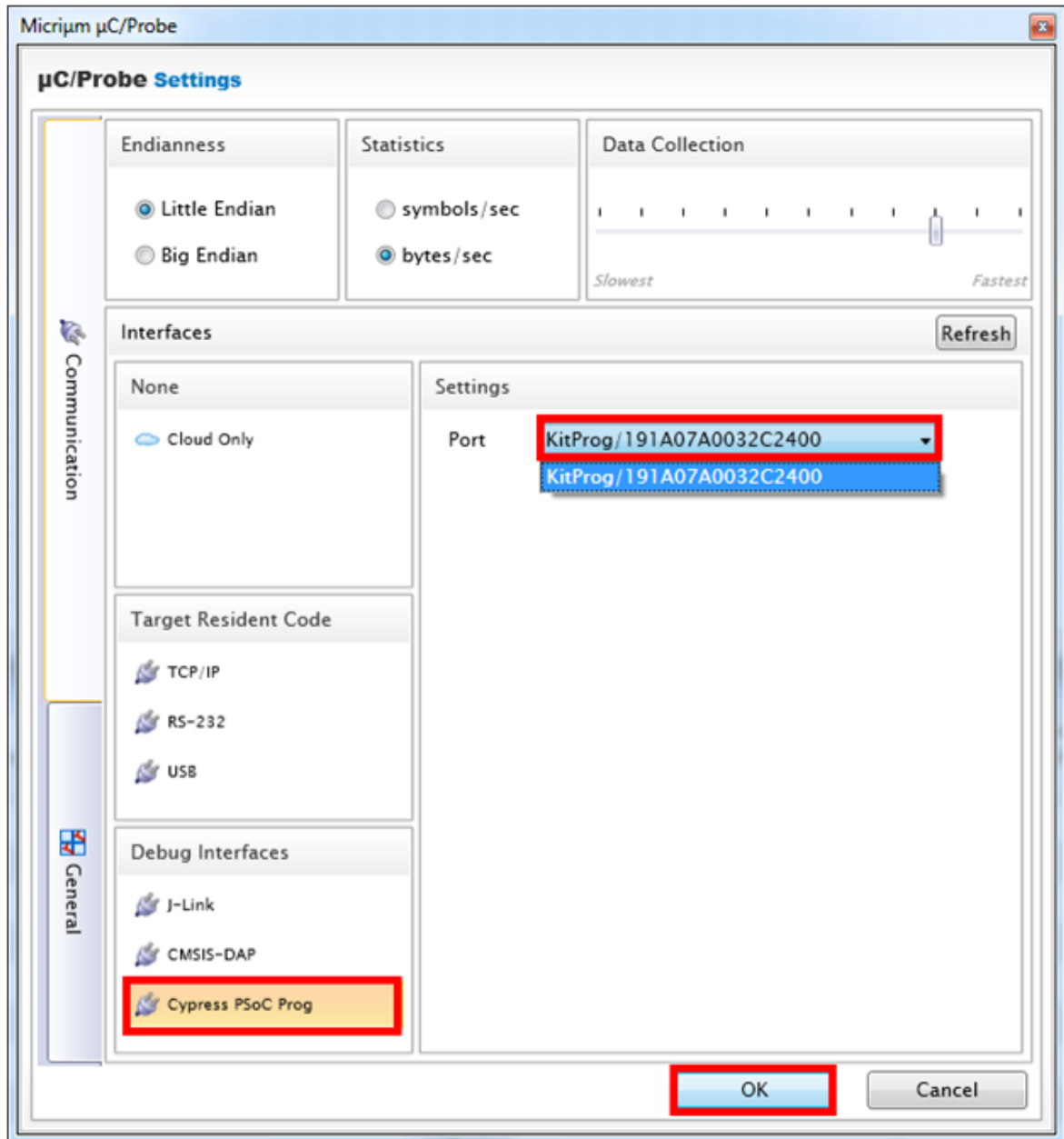

14. Click on Run button to start.

Figure 6-64. Run button



15. Now, move your finger on the CapSense slider on the kit and observe the Custom Slider and RGB Palette control output on the datascreen.

Figure 6-65. Custom Slider and RGB Palette output

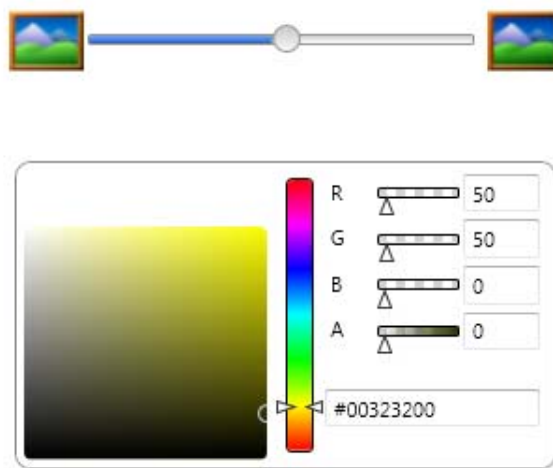

**Note:** If you are using Education edition of  $\mu$ C/Probe tool, pop-up windows will be displayed before starting datascreen. Click OK to continue. Also, the Datascreen (output) will time-out after 1 minute in case of Education edition.

16. Click on File tab and select Save to save the  $\mu$ C/Probe project. Provide an appropriate name and select a location to save your project. The  $\mu$ C/Probe projects are saved with extension .WSPX. Double clicking a .WSPX file opens the  $\mu$ C/Probe tool.

### 6.5.2 PWM Example project

The  $\mu$ C/Probe project for PWM project is already created and packaged along with kit content. The  $\mu$ C/Probe projects can be found in the installation folder at `<Install_Directory>\CY8CKIT-042 PSoC 4 Pioneer Kit\<version>\ $\mu$ CProbe`.

1. Program the PWM example project on CY8CKIT-042 by following steps 1–8 in Chapter 5.
2. Double click on CY8CKIT-042\_PWM.wsp file.

3. Browse and point to the PWM.elf file to load the symbols (global variables) from the PWM code example.
4. Connect the CY8CKIT-042 to PC and follow steps 12 to 14 described above to start running the datascreen.
5. The PWM compare values are displayed graphically and the RGB palette displays the RGB LED output on the datascreen.

Figure 6-66. PWM Compare values and RGB output

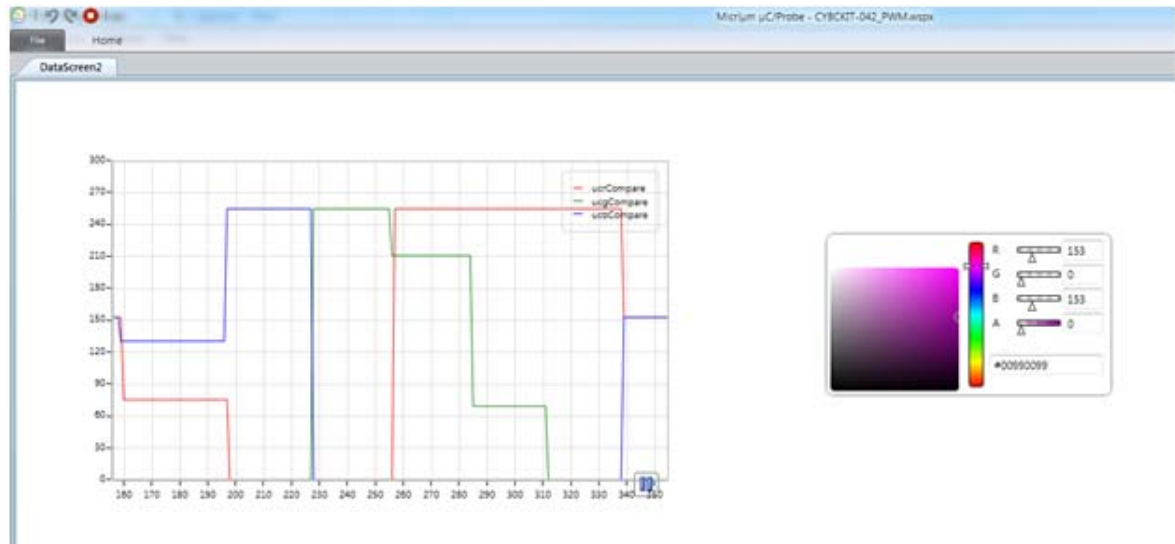



# A. Appendix



## A.1 CY8CKIT-042 Schematics

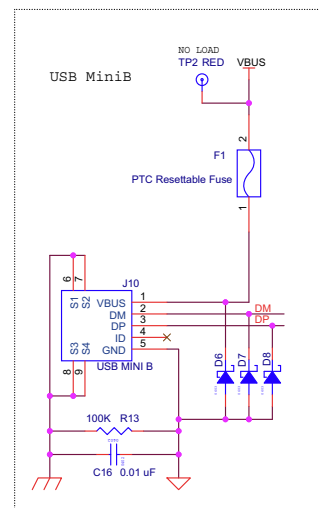
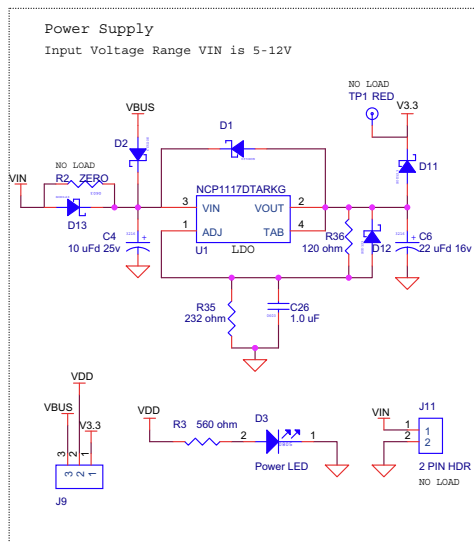
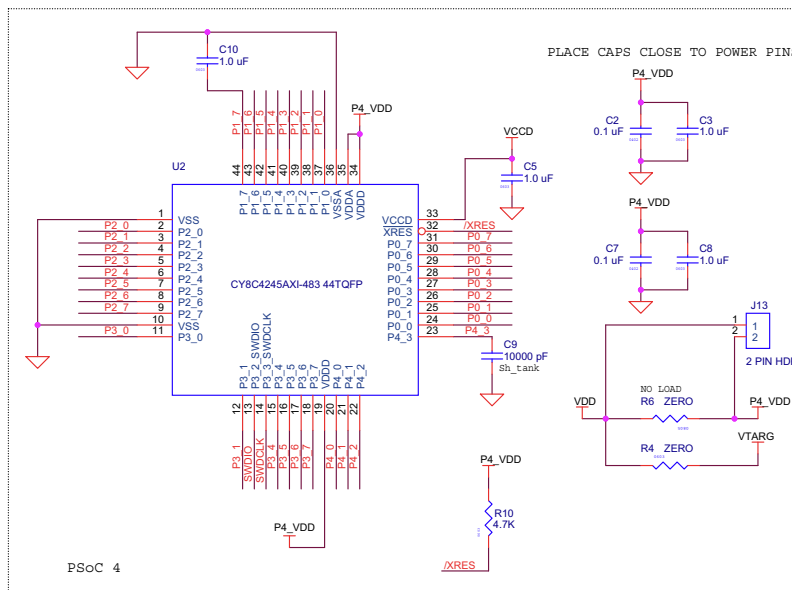

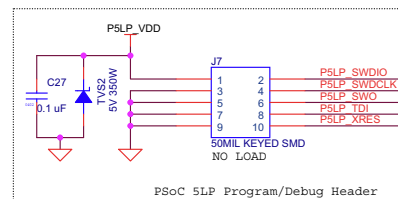
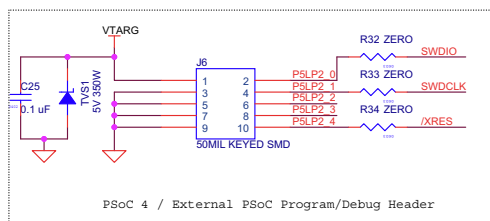
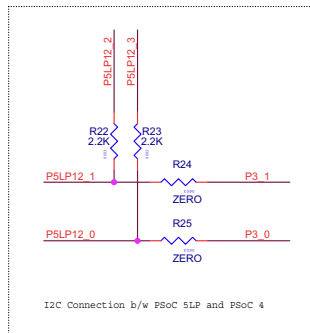
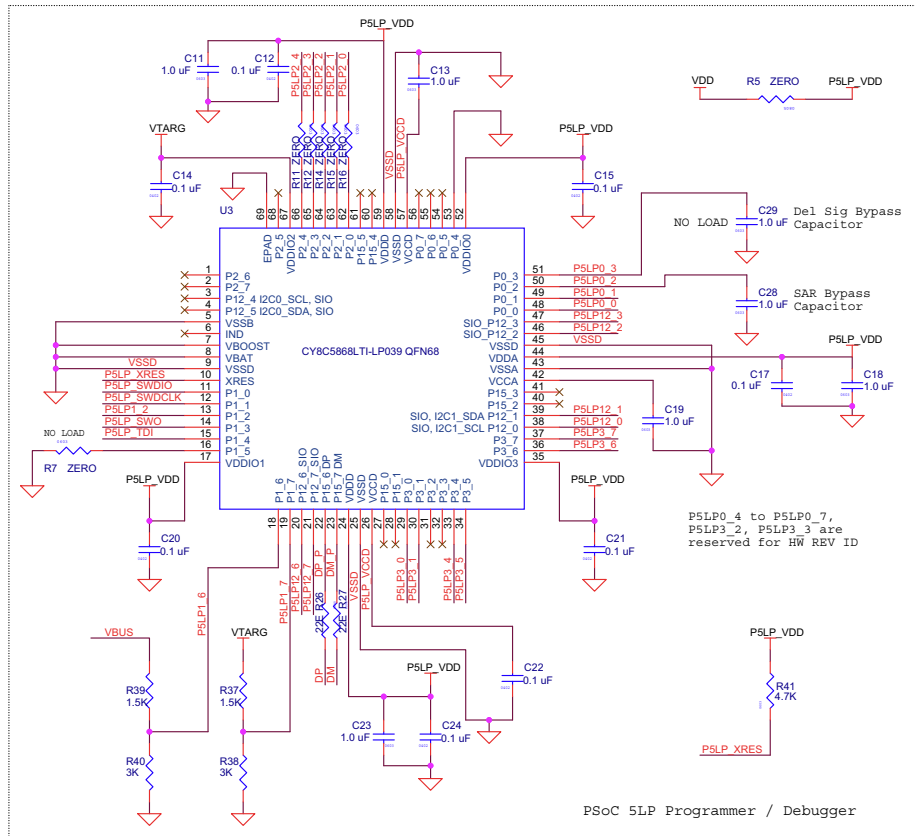

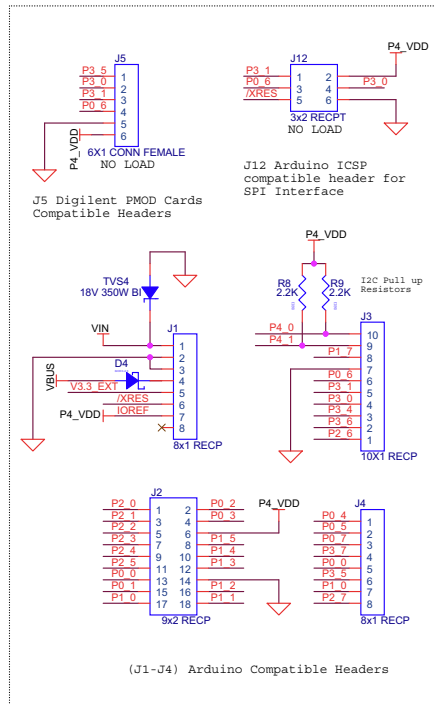
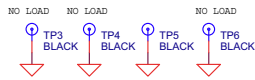
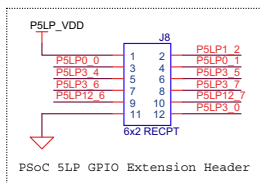
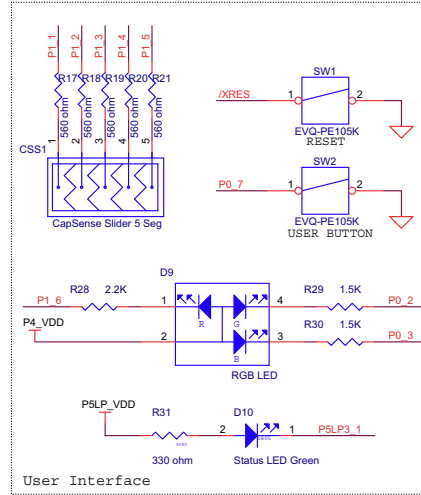
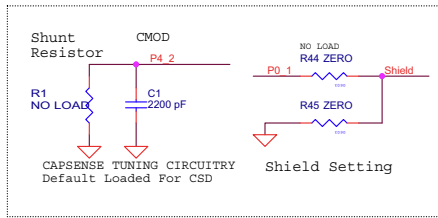

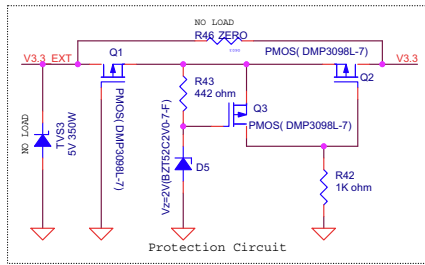

## A.2 Pin Assignment Table

This section provides the pin map of the headers and their usage.

### A.2.1 Arduino Compatible Headers (J1, J2, J3, J4, and J12)

J1		
Pin	Kit Signal	Description
J1_01	VIN	Input voltage to the board
J1_02	GND	GND
J1_03	GND	GND
J1_04	5V	5 V voltage
J1_05	3.3V	3.3 V voltage
J1_06	RESET	/XRES
J1_07	IOREF	I/O voltage reference
J1_08	NC	Not connected

J2					
Pin	PSoC 4 Signal	PSoC 4 Description	Pin	PSoC 4 Signal	PSoC 4 Description
J2_01	P2[0]	A0 (SARADC input)	J2_02	P0[2]	Comparator 2+
J2_03	P2[1]	A1 (SARADC input)	J2_04	P0[3]	Comparator 2-
J2_05	P2[2]	A2 (SARADC input)	J2_06	VDD	VDD
J2_07	P2[3]	A3 (SARADC input)	J2_08	P1[5]	Opamp 2+
J2_09	P2[4]	A4 (SARADC input)	J2_10	P1[4]	Opamp 2-
J2_11	P2[5]	A5 (SARADC input)	J2_12	P1[3]	Opamp 2out
J2_13	P0[0]	Comparator 1+	J2_14	GND	GND
J2_15	P0[1]	Comparator 1-	J2_16	P1[2]	Opamp 1out
J2_17	P1[0]	Opamp 1+	J2_18	P1[1]	Opamp 1-

<b>J3</b>		
<b>Pin</b>	<b>PSoC 4 Signal</b>	<b>PSoC 4 Description</b>
J3_01	P2[6]	D8
J3_02	P3[6]	D9(PWM)
J3_03	P3[4]	D10(PWM/SS)
J3_04	P3[0]	D11(PWM/MOSI)
J3_05	P3[1]	D12(MISO)
J3_06	P0[6]	D13(SCK)
J3_07	GND	GND
J3_08	P1[7]	AREF
J3_09	P4[1]	SDA
J3_10	P4[0]	SCL

<b>J4</b>		
<b>Pin</b>	<b>PSoC 4 Signal</b>	<b>PSoC 4 Description</b>
J4_01	P0[4]	D0(RX)
J4_02	P0[5]	D1(TX)
J4_03	P0[7]	D2
J4_04	P3[7]	D3(PWM)
J4_05	P0[0]	D4
J4_06	P3[5]	D5(PWM)
J4_07	P1[0]	D6(PWM)
J4_08	P2[7]	D7

<b>J12</b>		
<b>Pin</b>	<b>Kit Signal</b>	<b>PSoC 4 Description</b>
J12_01	P3[1]	MISO
J12_02	PSoC 4_VDD	VDD
J12_03	P0[6]	SCK
J12_04	P3[0]	MOSI
J12_05	/XRES	PSoC 4 RESET
J12_06	GND	GND

## A.2.2 Digilent Pmod Cards Support Header (J5)

J5		
Pin	Kit Signal	PSoC 4 Description (Default Pmod Signals)
J5_01	P3[5]	SPI_SS (multiplex with J4_06)
J5_02	P3[0]	SPI_MOSI
J5_03	P3[1]	SPI_MISO
J5_04	P0[6]	SPI_SCK
J5_05	GND	GND
J5_06	VDD	VCC

### A.2.3 PSoC 5LP GPIO Header (J8)

J8 is a 2×6 header that connects PSoC 5LP pins to support GPIO controls for custom PSoC 5LP projects.

J8					
Pin	PSoC 5LP Signal	PSoC 5LP Description	Pin	PSoC 5LP Signal	PSoC 5LP Description
J8_01	PSoC 5LP_VDD	VDD	J8_02	P1[2]	Digital I/O
J8_03	P0[0]	Delta Sigma ADC + input	J8_04	P0[1]	Delta Sigma ADC – input
J8_05	P3[4]	SAR – input	J8_06	P3[5]	SAR + input
J8_07	P3[6]	Buffered VDAC	J8_08	P3[7]	Buffered VDAC
J8_09	P12[6]	UART RX	J8_10	P12[7]	UART TX
J8_11	GND	GND	J8_12	P3[0]	IDAC output

## A.3 Program and Debug Headers

### A.3.1 PSoC 4 Direct Program/Debug Header (J6)

J6							
Pin	PSoC 5LP Signal	PSoC 4 Signal	Description	Pin	PSoC 5LP Signal	PSoC 4 Signal	Description
J6_01	VDD	VDD	VCC	J6_02	P2[0]	P3[2]	TMS/SWDIO
J6_03	GND	GND	GND	J6_04	P2[1]	P3[3]	TCLK/SWCLK
J6_05	GND	GND	GND	J6_06	P2[2]	NC	TDO/SWO
J6_07	NC	GND	GND	J6_08	P2[3]	NC	TDI
J6_09	GND	GND	GND	J6_10	P2[4]	XRES	RESET

### A.3.2 PSoC 5LP Direct Program/Debug Header (J7)

J7					
Pin	PSoC 5LP Signal	Description	Pin	PSoC 5LP Signal	Description
J7_01	VDD	VCC	J7_02	P1[0]	TMS/SWDIO
J7_03	GND	GND	J7_04	P1[1]	TCLK/SWCLK
J7_05	GND	GND	J7_06	P1[3]	TDO/SWO
J7_07	GND	GND	J7_08	P1[4]	TDI
J7_09	GND	GND	J7_10	XRES	RESET

## A.4 Use of Zero-ohm Resistors and No Load

Unit	Resistor	Usage
Power supply	R2	Solder zero-ohm resistors to access voltage from VBUS (USB).
I2C connection between PSoC 5LP and PSoC 4	R24 and R25	Unsolder the resistors to communicate with an external PSoC using the PSoC 5LP. Removing these will disable the PSoC 4 I2C communication with the PSoC 5LP device.
PSoC 4/external PSoC program/debug header	R32, R33, and R34	Unsolder the resistors to disconnect SWD lines from the PSoC 4. Use J6 to connect and program an external PSoC. Removing these will disable PSoC 4 programming by the PSoC 5LP device.
Protection circuit	R46	Solder zero-ohm resistors to bypass the entire protection circuitry.
CapSense tuning circuitry	R1	Used when Rbleed mode of the CSD is used. To use this feature, you must populate an Rbleed resistor. Refer to the CapSense component datasheet.
CapSense shield setting	R44, R45	Unsolder R45, which connects the shield to ground and solder R44 with zero-ohm resistors to connect Vref via P0_1.
PSoC 4	R4, R6	Unsolder R4 to remove supply to VTARG and solder zero-ohm resistors R6 to supply P4_VDD with VDD instead of J13.
PSoC 5LP programmer/debugger	R11, R12, R14, R15, R16	For future use.
	R5	Unsolder the zero-ohm resistor to cut the VDD supply to PSoC 5LP.
	R7	For future use.

## A.5 Error in Firmware/Status Indication in Status LED

	User Indication	Scenario	Action Required by user
1	LED blinks at a fast rate (ON Time = 0.25s, OFF Time = 0.25s)	Bootloadable file is corrupt	Bootload the *.cyacd file over the USB interface, which is shipped with PSoC Programmer using the Bootloader Host GUI shipped with PSoC Creator. The files are located in the PSoC Programmer root installation directory.
2	LED blinks at a slow rate (ON Time = 1.5s, OFF Time = 1.5s)	Entered Bootloader by pressing the PSoC 4 Reset switch	a) Unplug power and plug it in again if you entered this mode by mistake; the LED gives the indication. b) If the mode entry was intentional, bootload the new *.cyacd file using the Bootloader Host tool shipped with PSoC Creator.
3	LED glows steadily	Programmer application is running successfully	USB is enumerated successfully and the programmer is up and running. The PSoC 4 device can now be programmed any time using the onboard PSoC 5LP programmer.

**Note:** LED status is not applicable when a custom project is running in PSoC 5LP.



## A.6 Bill of Materials (BOM)

No.	Qty	Reference	Value	Description	Manufacturer	Mfr Part Number
1				PCB,3.32"x2.1" CAF resistant High Tg ENIG finish, 4 layer, Color = RED, Silk = WHITE.	Cypress	
2	1	C1	2200 pFd	CAP CER 2200PF 50V 5% NP0 0805	Murata	GRM2165C1H222JA01D
3	12	C2,C7,C12,C14,C15,C17,C20,C21,C22,C24,C25,C27	0.1 uFd	CAP .1UF 16V CERAMIC Y5V 0402	Panasonic - ECG	ECJ-0EF1C104Z
4	11	C3,C5,C8,C10,C11,C13,C18,C19,C23,C26,C28	1.0 uFd	CAP CERAMIC 1.0UF 25V X5R 0603 10%	Taiyo Yuden	TMK107BJ105KA-T
5	1	C4	10 uF 25V	CAP TANT 10UF 25V 10% 1210	AVX Corporation	TPSB106K025R1800
6	1	C6	22 uF 16V	CAP TANT 22UF 16V 10% 1210	AVX Corporation	TPSB226K016R0600
7	1	C9	10000 pFd	CAP CER 10000PF 50V 5% NP0 0805	Murata	GRM2195C1H103JA01D
8	1	C16	0.01 uFd	CAP 10000PF 16V CERAMIC 0402 SMD	Panasonic - ECG	ECJ-0EB1C103K
9	6	D1,D2,D4,D11,D12,D13	MBR05	DIODE SCHOTTKY 0.5A 20V SOD-123	Fairchild Semiconductor	MBR0520L
10	1	D3	Power LED Amber	LED AMBER 591NM DIFF LENS 2012	Sharp Microelectronics	LT1ZV40A
11	1	D5	2V Zener	DIODE ZENER 2V 500MW SOD123	Diodes Inc	BZT52C2V0-7-F
12	3	D6, D7, D8	ESD diode	SUPPRESSOR ESD 5VDC 0603 SMD	Bourns Inc.	CG0603MLC-05LE
13	1	D9	RGB LED	LED RED/GREEN/BLUE PLCC4 SMD	Cree, Inc.	CLV1A-FKB-CJ1M1F1BB7R4S3
14	1	D10	Status LED Green	LED GREEN CLEAR 0805 SMD	Chicago Miniature	CMD17-21VGC/TR8
15	1	F1	FUSE	PTC Resettable Fuses 15Volts 100Amps	Bourns	MF-MSMF050-2
16	2	J1, J4	8x1 RECP	CONN HEADER FEMALE 8POS .1" GOLD	Sullins Connector Solutions	PPPC081LFBN-RC
17	1	J2	9x2 RECP	CONN HEADER FMAL 18PS.1" DL GOLD	Sullins Connector Solutions	PPPC092LFBN-RC
18	1	J3	10x1 RECP	CONN HEADER FMALE 10POS .1" GOLD	Sullins Connector Solutions	PPPC101LFBN-RC
19	1	J6	50MIL KEYED SMD	CONN HEADER 10 PIN 50MIL KEYED SMD	Samtec	FTSH-105-01-L-DV-K
20	1	J8	6x2 RECP	CONN HEADER FMAL 12PS.1" DL GOLD	Sullins Connector Solutions	PPPC062LFBN-RC
21	1	J9	3p_jumper	CONN HEADER VERT SGL 3POS GOLD	3M	961103-6404-AR
22	1	J10	USB Mini B	CONN USB MINI AB SMT RIGHT ANGLE	TE Connectivity	1734035-2

No.	Qty	Reference	Value	Description	Manufacturer	Mfr Part Number
23	1	J13	2p_jumper	CONN HEADER VERT SGL 2POS GOLD	3M	961102-6404-AR
24	3	Q1,Q2,Q3	PMOS	MOSFET P-CH 30V 3.8A SOT23-3	Diodes Inc	DMP3098L-7
25	1	R3	560 Ω	RES 560 Ω 1/8W 5% 0805 SMD	Panasonic - ECG	ERJ-6GEYJ561V
26	12	R4,R11,R12,R14,R15, R16,R24,R25,R32,R33 ,R34,R45	ZERO	RES 0.0 Ω 1/10W 0603 SMD	Panasonic-ECG	ERJ-3GEY0R00V
27	1	R5	ZERO	RES 0.0 Ω 1/8W 0805 SMD	Panasonic-ECG	ERJ-6GEY0R00V
28	4	R8,R9,R22,R23	2.2K	RES 2.2 kΩ 1/10W 5% 0603 SMD	Panasonic - ECG	ERJ-3GEYJ222V
29	2	R10,R41	4.7K	RES 4.7 kΩ 1/10W 5% 0603 SMD	Panasonic-ECG	ERJ-3GEYJ472V
30	1	R13	100K	RES 100 kΩ 1/10W 5% 0402 SMD	Panasonic - ECG	ERJ-2GEJ104X
31	5	R17,R18,R19,R20,R21	560 Ω	RES 560 Ω 1/10W 5% 0603 SMD	Panasonic-ECG	ERJ-3GEYJ561V
32	2	R26, R27	22E	RES 22 Ω 1/10W 1% 0603 SMD	Panasonic - ECG	ERJ-3EKF22R0V
33	1	R28	2.2K	RES 2.2 kΩ 1/8W 5% 0805 SMD	Panasonic - ECG	ERJ-6GEYJ222V
34	2	R29,R30	1.5K	RES 1.5 kΩ 1/8W 5% 0805 SMD	Panasonic - ECG	ERJ-6GEYJ152V
35	1	R31	330 Ω	RES 330 Ω 1/8W 5% 0805 SMD	Panasonic - ECG	ERJ-6GEYJ331V
36	1	R35	232 Ω	RES 232 Ω 1/10W 1% 0603 SMD	Panasonic - ECG	ERJ-3EKF2320V
37	1	R36	120 Ω	RES 120 Ω 1/10W 1% 0603 SMD	Panasonic - ECG	ERJ-3EKF1200V
38	2	R37,R39	1.5K	RES 1.5K Ω 1/10W 5% 0603 SMD	Panasonic - ECG	ERJ-3GEYJ152V
39	2	R38,R40	3K	RES 3.0K Ω 1/10W 5% 0603 SMD	Panasonic - ECG	ERJ-3GEYJ302V
40	1	R42	1K	RES 1K Ω 1/8W 5% 0805 SMD	Panasonic - ECG	ERJ-6GEYJ102V
41	1	R43	442 Ω	RES 442 Ω 1/10W 1% 0603 SMD	Panasonic - ECG	ERJ-3EKF4420V
42	2	SW1,SW2	SW PUSH-BUTTON	SWITCH TACTILE SPST-NO 0.05A 12V	Panasonic - ECG	EVQ-PE105K
43	1	TP5	BLACK	TEST POINT PC MINI .040"D Black	Keystone Electronics	5001
44	2	TVS1,TVS2	5V 350W	TVS UNIDIR 350W 5V SOD-323	Diodes Inc.	SD05-7
45	1	TVS4	18V 350W	TVS DIODE 18V 1CH BI SMD	Bourns Inc.	CDSOD323-T18C
46	1	U1	NCP1117DT ARKG	NCP1117DTARKG	ON Semiconductor	NCP1117DTARKG
47	1	U2	PSoC 4 (CY8C4245A XI-483)	44TQFP PSoC4A target chip	Cypress Semicon-ductor	CY8C4245AXI-483
48	1	U3	PSoC 5LP (CY8C5868L TI-LP039 )	68QFN PSoC 5LP chip for USB debug channel and USB-Serial interface	Cypress Semicon-ductor	CY8C5868LTI-LP039
<b>No Load Components</b>						
49	1	C29	1.0 uFd	CAP CERAMIC 1.0UF 25V X5R 0603 10%	Taiyo Yuden	TMK107BJ105KA-T

No.	Qty	Reference	Value	Description	Manufacturer	Mfr Part Number
50	1	J5	6X1 RECP RA	CONN FEMALE 6POS .100" R/A GOLD	Sullins Connector Solutions	PPPC061LGBN-RC
51	1	J7	50MIL KEYED SMD	CONN HEADER 10 PIN 50MIL KEYED SMD	Samtec	FTSH-105-01-L-DV-K
52	1	J11	2 PIN HDR	CONN HEADER FEMALE 2POS .1" GOLD	Sullins Connector Solutions	PPPC021LFBN-RC
53	1	J12	3x2 RECPT	CONN HEADER FMAL 6PS .1" DL GOLD	Sullins Connector Solutions	PPPC032LFBN-RC
54	5	R1,R2,R7,R44,R46	ZERO	RES 0.0 Ω 1/10W 0603 SMD	Panasonic-ECG	ERJ-3GEY0R00V
55	1	R6	ZERO	RES 0.0 Ω 1/8W 0805 SMD	Panasonic-ECG	ERJ-6GEY0R00V
56	2	TP1,TP2	RED	TEST POINT PC MINI .040"D RED	Keystone Electronics	5000
57	3	TP3,TP4,TP6	BLACK	TEST POINT PC MINI .040"D Black	Keystone Electronics	5001
58	1	TVS3	5V 350W	TVS UNIDIR 350W 5V SOD-323	Dioded Inc.	SD05-7
<b>Install on Bottom of PCB As per the Silk Screen in the Corners</b>						
59	4	N/A	N/A	BUMPON CYLINDRICAL.312X.215 BLACK	3M	SJ61A6
<b>Special Jumper Installation Instructions</b>						
60	1	J9	Install jumper across pins 1 and 2	Rectangular Connectors MINI JUMPER GF 6.0MM CLOSE TYPE BLACK	Kobiconn	151-8010-E
61	1	J13	Install jumper across pins 1 and 2	Rectangular Connectors MINI JUMPER GF 6.0MM CLOSE TYPE BLACK	Kobiconn	151-8010-E
<b>Label</b>						
62	1	N/A	N/A	LBL, Kit Product Identification Label, Vendor Code, Datecode, Serial Number CY8CKIT-042 Rev** (YYWWV- VXXXXX)	Cypress Semicon- ductor	
63	1	N/A	N/A	LBL, PCBA Anti-Static Warning, 10mm X 10mm	Cypress Semicon- ductor	
64	1	N/A	N/A	Assembly Adhesive Label, Manufactur- ing ID	Cypress Semicon- ductor	
65	1	N/A	N/A	Kit QR code	Cypress Semicon- ductor	

## A.7 Regulatory Compliance Information

The CY8CKIT-042 PSoc 4 Pioneer Kit has been tested and verified to comply with the following electromagnetic compatibility (EMC) regulations:

- EN 55022:2010 Class A - Emissions
- EN 55024:2010 Class A - Immunity

## A.8 Migrating projects across different Pioneer series kits

All Cypress Pioneer series kits are Arduino Uno compatible and have some common on-board peripherals such as RGB LED, CapSense and User Switch. However, the pin mapping in each of the boards is different due to differences in pin functions of the PSoC device used. This guide lists the pin maps of the Pioneer series kits to allow for easy migration of projects across different kits.

In some cases, the pins available on the Pioneer kit headers are a superset of the standard Arduino Uno pins. For example J2 contains only 1 row of pins on the Arduino Uno pinout while it contains 2 rows of pins on many of the Pioneer series kits.

Figure A-1. Pioneer series kits pin map

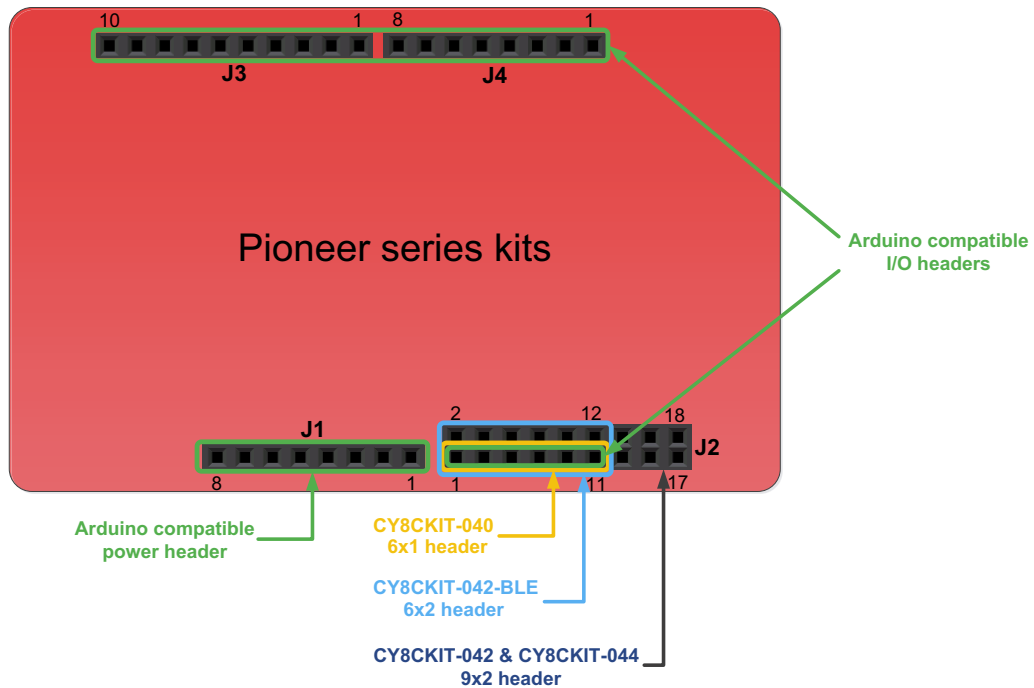

## A.8.1 Arduino Uno Compatible Headers

J1 Arduino Compatible Header Pin Map					
Pin #	Arduino Pin	Pioneer series kits			
		CY8CKIT-042	CY8CKIT-040	CY8CKIT-042-BLE	CY8CKIT-044
1	VIN	VIN	VIN	VIN	VIN
2	GND	GND	GND	GND	GND
3	GND	GND	GND	GND	GND
4	5V	V5.0	V5.0	V5.0	V5.0
5	3.3V	V3.3	V3.3	V3.3	V3.3
6	RESET	RESET	RESET	RESET	RESET
7	IOREF	P4.VDD	P4.VDD	BLE.VDD	P4.VDD
8	NC	NC	NC	NC	NC

J2 Arduino Compatible Header Pin Map					
Pin #	Arduino Pin	Pioneer series kits			
		CY8CKIT-042	CY8CKIT-040	CY8CKIT-042-BLE	CY8CKIT-044
1	A0	P2[0]	P0[0]	P3[0]	P2[0]
2	–	P0[2]*	–	P2[0]	P2[6]*
3	A1	P2[1]	P0[1]	P3[1]	P2[1]
4	–	P0[3]*	–	P2[1]*	P6[5]*
5	A2	P2[2]	P0[2]*	P3[2]	P2[2]
6	–	P4_VDD	–	P2[2]*	P0[6]*
7	A3	P2[3]	P0[4]*	P3[3]	P2[3]
8	–	P1[5]*	–	P2[3]*	P4[4]*
9	A4	P2[4]	P1[3]	P3[4]	P2[4]
10	–	P1[4]*	–	P2[4]*	P4[5]*
11	A5	P2[5]	P1[2]	P3[5]	P2[5]
12	–	P1[3]*	–	P2[5]*	P4[6]*
13	–	P0[0]	–	–	P0[0]
14	–	GND	–	–	GND
15	–	P0[1]	–	–	P0[1]
16	–	P1[2]*	–	–	P3[4]*
17	–	P1[0]	–	–	P0[7]*
18	–	P1[1]*	–	–	P3[5]*

\* These pins are also used for on-board peripherals. See the tables in the On-Board Peripherals section below for details.

J3 Arduino Compatible Header Pin Map					
Pin #	Arduino Pin	Pioneer series kits			
		CY8CKIT-042	CY8CKIT-040	CY8CKIT-042-BLE	CY8CKIT-044
1	D8	P2[6]	P1[4]	P0[5]	P0[2]
2	D9	P3[6]	P1[5]	P0[4]	P0[3]
3	D10	P3[4]	P1[6]	P0[2]	P2[7]
4	D11	P3[0]	P1[1]*	P0[0]	P6[0]
5	D12	P3[1]	P3[1]	P0[1]	P6[1]
6	D13	P0[6]	P1[7]	P0[3]	P6[2]
7	GND	GND	GND	GND	GND
8	AREF	P1[7]	NC	VREF	P1[7]
9	SDA	P4[1]	P1[3]	P3[4]	P4[1]
10	SCL	P4[0]	P1[2]	P3[5]	P4[0]

\* These pins are also used for on-board peripherals. See the tables in the On-Board Peripherals section below for connection details.

J4 Arduino Compatible Header Pin Map					
Pin #	Arduino Pin	Pioneer series kits			
		CY8CKIT-042	CY8CKIT-040	CY8CKIT-042-BLE	CY8CKIT-044
1	D0	P0[4]	P0[5]	P1[4]	P3[0]
2	D1	P0[5]	P0[6]	P1[5]	P3[1]
3	D2	P0[7]*	P0[7]	P1[6]	P1[0]
4	D3	P3[7]	P3[2]*	P1[7]	P1[1]
5	D4	P0[0]	P0[3]	P1[3]	P1[2]
6	D5	P3[5]	P3[0]	P1[2]	P1[3]
7	D6	P1[0]	P1[0]	P1[1]	P5[3]
8	D7	P2[7]	P2[0]*	P1[0]	P5[5]

\* These pins are also used for on-board peripherals. See the tables in the On-Board Peripherals section below for connection details.

## A.8.2 On-Board Peripherals

CapSense Pin Map					
Pin #	Description	Pioneer series kits			
		CY8CKIT-042 (Linear Slider)	CY8CKIT-040	CY8CKIT-042-BLE (Linear Slider)	CY8CKIT-044 (Gesture Pad)
1	CSS1	P1[1]	–	P2[1]	P4[4]
2	CSS2	P1[2]	–	P2[2]	P4[5]
3	CSS3	P1[3]	–	P2[3]	P4[6]
4	CSS4	P1[4]	–	P2[4]	P3[4]
5	CSS5	P1[5]	–	P2[5]	P3[5]
6	CMOD	P4[2]	P0[4]	P4[0]	P4[2]
7	CTANK	P4[3]	P0[2]	P4[1]	P4[3]

Proximity header Pin Map					
Pin #	Description	Pioneer series kits			
		CY8CKIT-042	CY8CKIT-040	CY8CKIT-042-BLE	CY8CKIT-044
1	PROXIMITY	–	P2[0]	P2[0]	P3[7]
2		–	–	–	P3[6]

RGB LED Pin Map					
Pin #	Color	Pioneer series kits			
		CY8CKIT-042	CY8CKIT-040	CY8CKIT-042-BLE	CY8CKIT-044
1	Red	P1[6]	P3[2]	P2[6]	P0[6]
2	Green	P0[2]	P1[1]	P3[6]	P2[6]
3	Blue	P0[3]	P0[2]	P3[7]	P6[5]

User Switch Pin Map					
Pin #	Description	Pioneer series kits			
		CY8CKIT-042	CY8CKIT-040	CY8CKIT-042-BLE	CY8CKIT-044
1	SW2	P0[7]	–	P2[7]	P0[7]

# Revision History



## Document Revision History

### CY8CKIT-042 PSoC® 4 Pioneer Kit Guide Revision History

Document Title: CY8CKIT-042 PSoC® 4 Pioneer Kit Guide				
Document Number: 001-86371				
Revision	ECN#	Issue Date	Origin of Change	Description of Change
**	3978908	04/23/2013	ANCY	Initial version of kit guide.
*A	3981609	04/25/2013	ANCY	Minor changes across the guide.
*B	4008979	05/23/2013	RKAD	Minor changes across the guide. Updated <a href="#">Introduction chapter on page 7</a> : Updated <a href="#">"Kit Contents" on page 7</a> : Updated <a href="#">Figure 1-1</a> . Updated <a href="#">Advanced Topics chapter on page 66</a> : Added <a href="#">"PSoC 5LP Factory Program Restore Instructions" on page 97</a> .
*C	4107338	08/23/2013	SASH	Minor changes across the guide. Updated <a href="#">Code Examples chapter on page 47</a> : Updated <a href="#">Figure 5-2</a> . Updated <a href="#">Figure 5-3</a> .
*D	4202835	11/26/2013	SASH	Updated PSoC Creator images. Added figure captions. Updated <a href="#">Introduction chapter on page 7</a> : Updated <a href="#">"Additional Learning Resources" on page 10</a> : Updated PSoC Creator training web link. Updated <a href="#">Code Examples chapter on page 47</a> : Modified the CapSense code example.
*E	4757883	05/07/2015	SASH / MSUR	Updated <a href="#">Introduction chapter on page 7</a> : Updated <a href="#">"Additional Learning Resources" on page 10</a> : Updated description. Updated <a href="#">"PSoC Creator Code Examples" on page 12</a> : Updated <a href="#">Figure 1-4</a> .



**CY8CKIT-042 PSoC® 4 Pioneer Kit Guide Revision History (continued)**

Document Title: CY8CKIT-042 PSoC® 4 Pioneer Kit Guide				
Document Number: 001-86371				
Revision	ECN#	Issue Date	Origin of Change	Description of Change
*E (cont.)	4757883	05/07/2015	SASH / MSUR	Updated <a href="#">Software Installation</a> chapter on page 15: Updated “Install Kit Software” on page 15: Updated description. Updated “Install Software” on page 16: Updated description. Updated “Develop Code Fast and Easy with Code Examples” on page 17: Updated <a href="#">Figure 2-3</a> . Updated <a href="#">Figure 2-4</a> . Updated “Open an Example Project in PSoC Creator” on page 19: Updated <a href="#">Figure 2-6</a> .
				Updated <a href="#">Kit Operation</a> chapter on page 21: Updated “Pioneer Kit USB Connection” on page 22: Updated <a href="#">Table 3-1</a> : Updated entire table. Removed figure “KitProg Driver Installation”. Updated <a href="#">Figure 3-2</a> . Updated “Programming and Debugging PSoC 4” on page 23: Updated “Using CY8CKIT-002 MiniProg3 Programmer and Debugger” on page 25: Updated <a href="#">Figure 3-8</a> . Updated description.
				Updated <a href="#">Hardware</a> chapter on page 31: Updated “Functional Description” on page 34: Updated “Arduino Compatible Headers (J1, J2, J3, J4, and J12 - unpopulated)” on page 40: Updated description.

**CY8CKIT-042 PSoC® 4 Pioneer Kit Guide Revision History (continued)**

Document Title: CY8CKIT-042 PSoC® 4 Pioneer Kit Guide				
Document Number: 001-86371				
Revision	ECN#	Issue Date	Origin of Change	Description of Change
*E (cont.)	4757883	05/07/2015	SASH / MSUR	<p>Updated <a href="#">Code Examples chapter</a> on page 47: Updated description.</p> <p>Updated <a href="#">“Project: Blinking LED”</a> on page 50: Updated <a href="#">“Hardware Connections”</a> on page 50: Updated <a href="#">Table 5-1</a>: Updated details in “Pin Name” column. Updated <a href="#">Figure 5-8</a>. Updated <a href="#">“Flow Chart”</a> on page 51: Updated description. Updated <a href="#">“Project: PWM”</a> on page 52: Updated <a href="#">“Hardware Connections”</a> on page 52: Updated <a href="#">Table 5-2</a>: Updated details in “Pin Name” column. Updated <a href="#">Figure 5-12</a>. Updated <a href="#">“Project: Deep Sleep”</a> on page 54: Updated <a href="#">“Hardware Connections”</a> on page 54: Updated <a href="#">Table 5-3</a>: Updated details in “Pin Name” column. Updated <a href="#">Figure 5-15</a>. Updated <a href="#">“Project: CapSense”</a> on page 56: Updated <a href="#">“CapSense (Without Tuning)”</a> on page 56: Updated <a href="#">“Hardware Connections”</a> on page 57: Updated <a href="#">Table 5-4</a>: Updated details in “Pin Name” column. Updated <a href="#">Figure 5-18</a>. Updated <a href="#">“CapSense (With Tuning)”</a> on page 59: Updated <a href="#">“Launching Tuner GUI”</a> on page 60: Updated <a href="#">Figure 5-22</a>. Updated <a href="#">Figure 5-23</a>. Updated <a href="#">“Verify Output”</a> on page 62: Updated description. Updated <a href="#">Figure 5-25</a>. Updated <a href="#">Figure 5-26</a>. Updated <a href="#">Figure 5-27</a>. Updated <a href="#">Figure 5-28</a>.</p>

**CY8CKIT-042 PSoC® 4 Pioneer Kit Guide Revision History (continued)**

Document Title: CY8CKIT-042 PSoC® 4 Pioneer Kit Guide				
Document Number: 001-86371				
Revision	ECN#	Issue Date	Origin of Change	Description of Change
*E (cont.)	4757883	05/07/2015	SASH / MSUR	<p>Updated <a href="#">Advanced Topics</a> chapter on page 66:</p> <p>Updated “<a href="#">Using PSoC 5LP as USB-UART Bridge</a>” on page 66:</p> <p>Updated description.</p> <p>Updated <a href="#">Figure 6-1</a>.</p> <p>Updated <a href="#">Figure 6-2</a>.</p> <p>Updated <a href="#">Figure 6-4</a>.</p> <p>Updated <a href="#">Figure 6-5</a>.</p> <p>Updated <a href="#">Figure 6-6</a>.</p> <p>Updated <a href="#">Figure 6-7</a>.</p> <p>Updated “<a href="#">Using PSoC 5LP as USB-I2C Bridge</a>” on page 79:</p> <p>Updated description.</p> <p>Updated <a href="#">Figure 6-19</a>.</p> <p>Updated <a href="#">Figure 6-20</a>.</p> <p>Updated <a href="#">Figure 6-22</a>.</p> <p>Updated <a href="#">Figure 6-23</a>.</p> <p>Added <a href="#">Figure 6-24</a>.</p> <p>Updated <a href="#">Figure 6-25</a>.</p> <p>Updated “<a href="#">Developing Applications for PSoC 5LP</a>” on page 88:</p> <p>Updated “<a href="#">Building a Bootloadable Project for PSoC 5LP</a>” on page 88:</p> <p>Updated description.</p> <p>Updated <a href="#">Figure 6-33</a>.</p> <p>Updated <a href="#">Figure 6-35</a>.</p> <p>Added <a href="#">Figure 6-39</a>.</p> <p>Updated <a href="#">Figure 6-40</a>.</p> <p>Updated “<a href="#">Building a Normal Project for PSoC 5LP</a>” on page 96:</p> <p>Updated <a href="#">Figure 6-45</a>.</p> <p>Updated “<a href="#">PSoC 5LP Factory Program Restore Instructions</a>” on page 97:</p> <p>Updated “<a href="#">PSoC 5LP is Programmed with a Bootloadable Application</a>” on page 97:</p> <p>Updated “<a href="#">Restore PSoC 5LP Factory Program Using PSoC Programmer</a>” on page 97:</p> <p>Updated description.</p> <p>Updated “<a href="#">PSoC 5LP is Programmed with a Standard Application</a>” on page 102:</p> <p>Updated description.</p> <p>Added “<a href="#">Using µC/Probe Tool</a>” on page 104.</p>

**CY8CKIT-042 PSoC® 4 Pioneer Kit Guide Revision History (continued)**

Document Title: CY8CKIT-042 PSoC® 4 Pioneer Kit Guide				
Document Number: 001-86371				
Revision	ECN#	Issue Date	Origin of Change	Description of Change
*E (cont.)	4757883	05/07/2015	SASH / MSUR	Updated <a href="#">Appendix chapter on page 113</a> : Updated "CY8CKIT-042 Schematics" on page 113: Updated entire section. Updated "Use of Zero-ohm Resistors and No Load" on page 120: Updated table. Added "Migrating projects across different Pioneer series kits" on page 124.
*F	4897811	09/14/2015	SRDS	Updated images and fixed hyperlinks.
*G	5201185	04/01/2016	RKAD	Sunset review; no content updates