

1. Scope of Application

These specifications apply to chip type LED lamp, CITILIGHT, model CL-773F-CW18K2-SDW-T.

2. Part code

**CL-773F-CW18K2-SDW-T**

Series

773F : SMD TYPE (2016 size)

Chip & Color code

CW18 : High brightness white

K2 : Specification number

Appearance code

SDW : Diffused / Whitish resin appearance

Shipping mode

Non-coded : Bulk

T : Taping (standard)

			Approved	Checked	Drawn	Symbol	CITILIGHT
						Name	CL-773F-CW18K2-SDW
						Drawing No	
-							
Mark	Date	Description	Appro.	CITIZEN ELECTRONICS CO.,LTD.			

3. Outline drawing

unit : mm

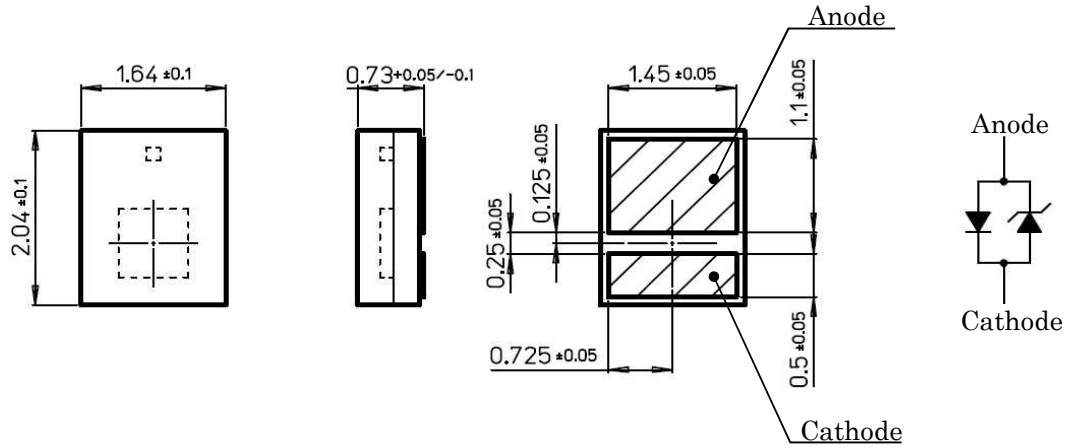

4. Performance

(1) Absolute Maximum Rating (Ta=25°C)

Parameter	Symbol	Rating Value	Unit
Power Dissipation(DC)	Pd	1.65	W
Forward Current*1	IF	500	mA
Forward Pulse Current *2	IFP	2000	mA
Tj max (DC / Pulse)	Tj	135 / 150	°C
Operating Temperature*3	Top	-40 ~ +85	°C
Storage Temperature*3	Tst	-40 ~ +85	°C

\*1 IF conditions: Maximum DC driving requires appropriate thermal management, or damage on the device may occur.

\*2 (a) IFP=500mA-1500mA : Pulse Width ≤ 500msec, Duty ≤ 10%, Ta=25°C  
 (b) IFP=1500mA-2000mA : Pulse Width ≤ 33msec, Duty ≤ 6.6%, Ta=25°C

\*3 Max temperature is with RH<50%

Please consult us when this product is used under any other conditions.

			Approved	Checked	Drawn	Symbol	CITILIGHT
						Name	CL-773F-CW18K2-SDW
						Drawing No	
Mark	Date	Description	Appro.	CITIZEN ELECTRONICS CO.,LTD.			

(2)-1 Electro-optical Characteristic

Parameter	Symbol	Condition	MIN	TYP	MAX	Unit
Forward Voltage *1	VF	IF=1000mA*7	3.2	3.5	3.8	V
Luminous Flux *2,3	Φv	IF=1000mA*7	220	250	290	lm
Chromaticity coordinates*4,5,6	x , y	IF=1000mA*7	next page			-
CCT Range	-	IF=1000mA*7	2500	2700	2900	K
View Angle at 50% Intensity	2φ	-		(120)		deg

- \*1 The tolerance of Forward Voltage measurement is ±3% at our tester.
- \*2 In accordance with NIST standard.
- \*3 The tolerance of Luminous Intensity measurement is ±10% at our tester.
- \*4 Chromaticity coordinates is the area surrounded with a,b,c,d.
- \*5 Chromaticity coordinates on CIE1931 diagram is following(reference)
- \*6 The tolerance of the Chromaticity coordinates measurement shall be under ±0.01.
- \*7 Characteristics are measured during a pulse of 20ms.

			Approved	Checked	Drawn	Symbol	CITILIGHT
						Name	CL-773F-CW18K2-SDW
						Drawing No	
-							
Mark	Date	Description	APPRO. CITIZEN ELECTRONICS CO.,LTD.				

(2)-2 Electro-optical Characteristic

Parameter	Symbol	Condition		x(±0.01)	y(±0.01)
Chromaticity coordinates *4,5,6	x , y	IF=1000mA*7	a	0.4440	0.4068
			b	0.4583	0.4349
			c	0.4939	0.4420
			d	0.4755	0.4129

\*4 Chromaticity coordinates is the area surrounded with a,b,c,d.

\*5 Chromaticity coordinates on CIE1931 diagram is following(reference)

\*6 The tolerance of the Chromaticity coordinates measurement shall be under ±0.01.

\*7 Characteristics are measured during a pulse of 20ms.

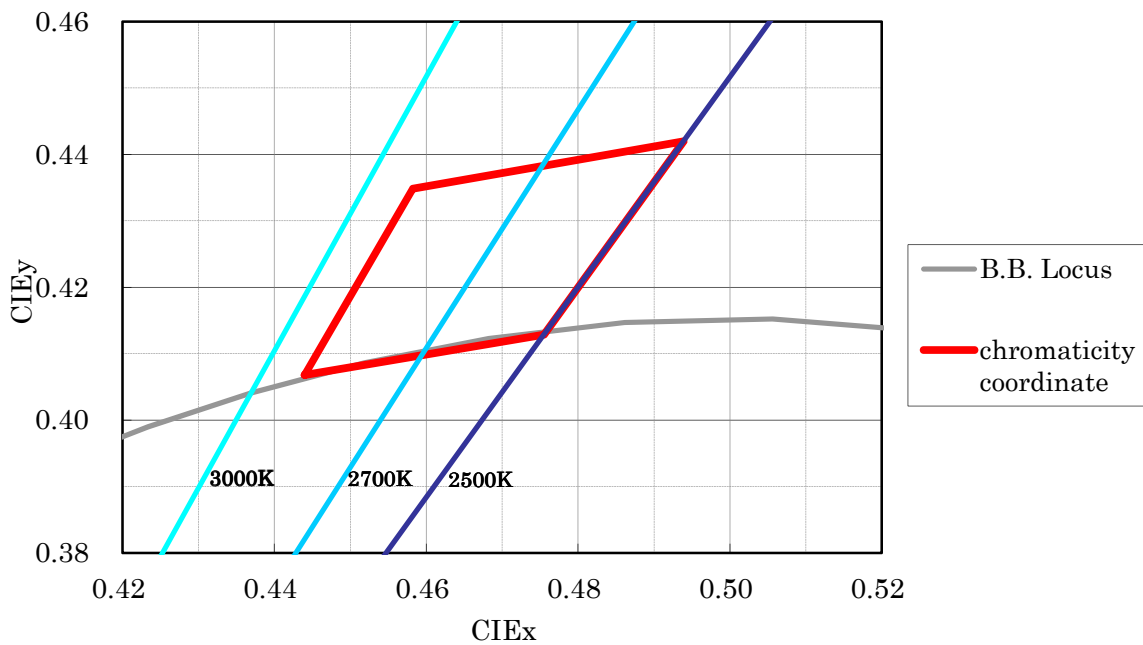

Note 1) For handling, please apply CMOS LSI or equivalent to prevent any electrostatic effect

			Approved	Checked	Drawn	Symbol	CITILIGHT
						Name	CL-773F-CW18K2-SDW
						Drawing No	
Mark	Date	Description	Appro.	CITIZEN ELECTRONICS CO.,LTD.			

5. Characteristic

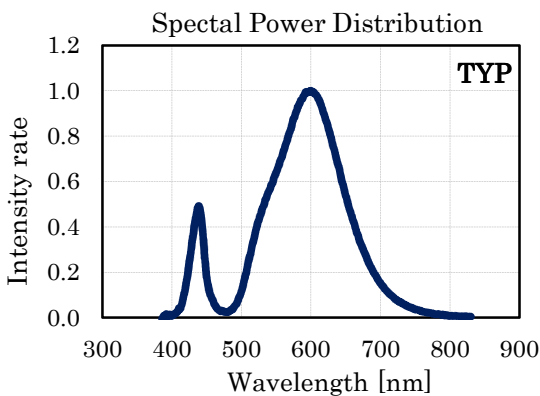
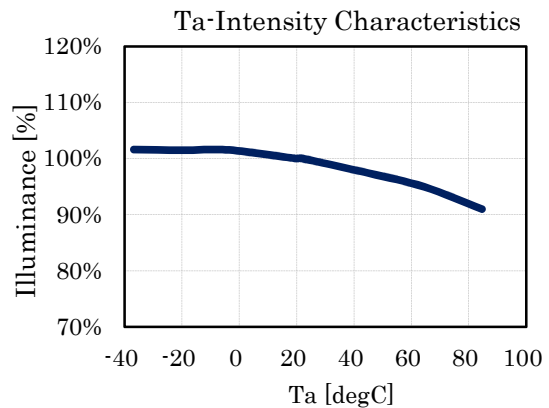
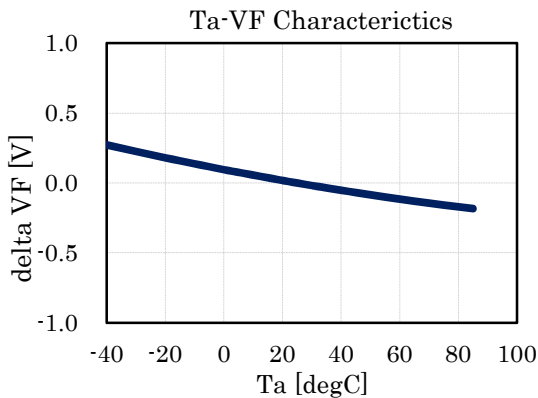
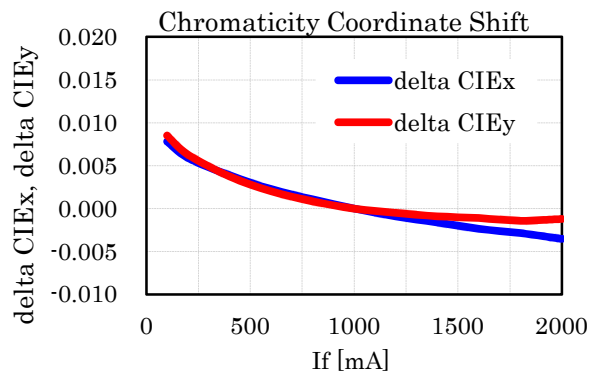
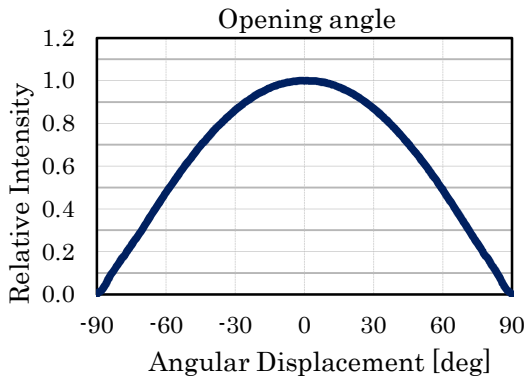
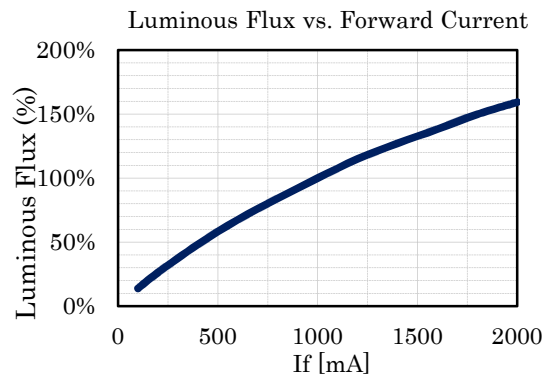
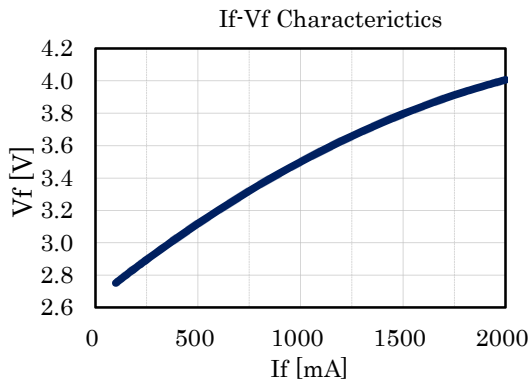

			Approved	Checked	Drawn	Symbol	CITILIGHT
						Name	CL-773F-CW18K2-SDW
						Drawing No	
Mark	Date	Description	APPRO.				
CITIZEN ELECTRONICS CO.,LTD.							

## 6. Reliability test

## Test item

Test	Test condition
Life Test in Continuous Operation	To operate the test under IF=500mA at Tj=135±3°C for 240 hours
Low Temperature Storage Test	-40 °C × 500 hours
High Temperature Storage Test	85 °C × 500 hours
Moisture proof Test	60 ±2°C, 90 ±5%RH for 500 hours
Thermal Shock Test	-40°C × 30 minutes - 85°C × 30 minutes, 5-cycle
Solder Heat Resistance Test	Recommended temperature profile (reflow soldering) × 3. (2nd test must be started after the samples are stabilized thermally.)
Electro Static Discharge test	EIAJ standard ED-4701-304 reference test (Human Body Model) Show 2KV or more pressure-resistant against static under the condition that R=1.5KΩ C=100pF EIAJ standard ED-4701-304 reference test (Machine Model) Show 200V or more pressure-resistant against static under the condition that R=0Ω C=200pF

## Judgment Criteria

Measuring item	Symbol	Measuring	failure criteria
Forward voltage	VF	IFP=1000mA	X < S×1.2
Luminous intensity	IV	IFP=1000mA	S×0.5 < X

S means the initial value. X means the tested sample Value.

Note: Measurement shall be taken between 2 hours and 24 hours, having returned the test pieces to the normal ambient conditions after the completion of each test.

			Approved	Checked	Drawn	Symbol	CITILIGHT
						Name	CL-773F-CW18K2-SDW
						Drawing No	
-							
Mark	Date	Description	Appro.	CITIZEN ELECTRONICS CO.,LTD.			

7. Taping Specifications (in accordance with JIS standard)

(1) Shape and Dimensions of Reel

unit : mm

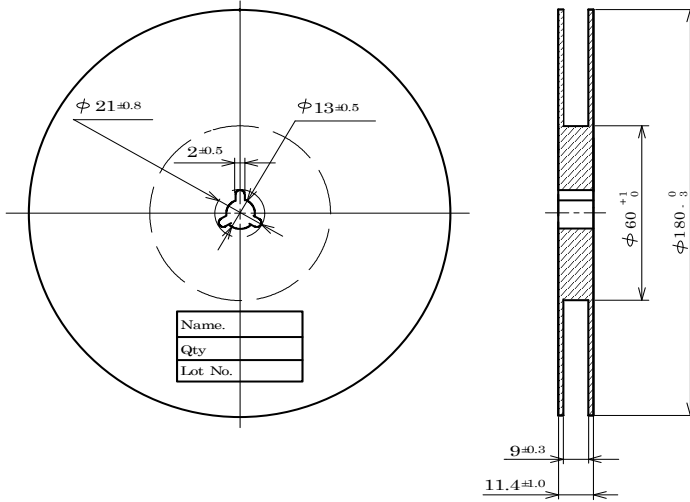

(2) Dimensions of Tape

unit : mm

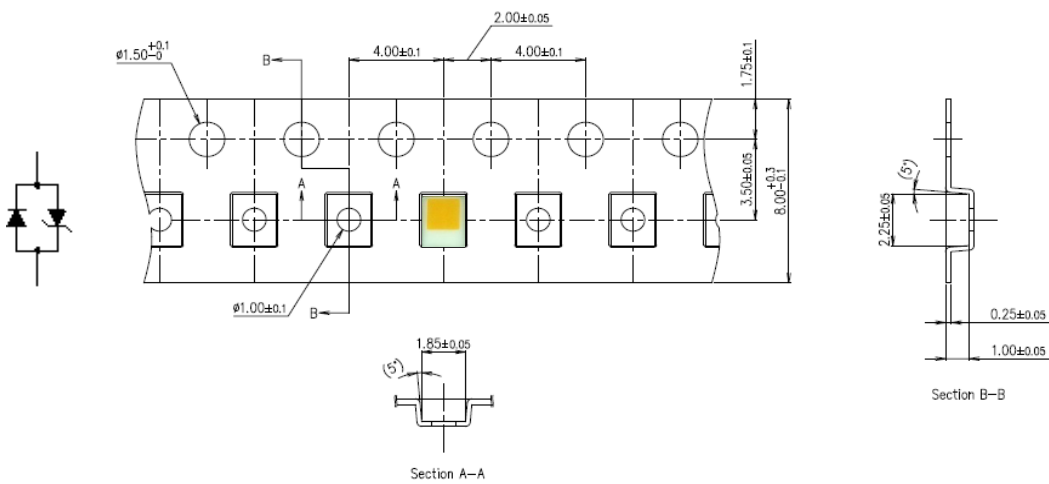

(3) Configuration of Tape

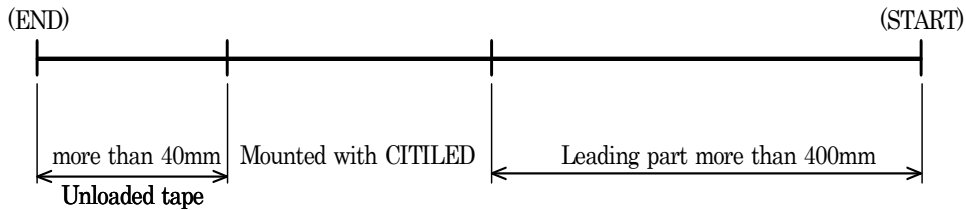

(4) Quantity : 3000 pcs/reel

(In case the qty/reel is less than 3000pcs for some reason, we will preannounce it.)

			Approved	Checked	Drawn	Symbol	CITILIGHT	
						Name	CL-773F-CW18K2-SDW	
						Drawing No		
Mark	Date	Description	APPRO.					CITIZEN ELECTRONICS CO.,LTD.

8. Packing Specifications

8-1. Moisture-proof Packing

To prevent moisture absorption during transportation and storage, reels are packed in aluminum envelopes which contain a desiccant.

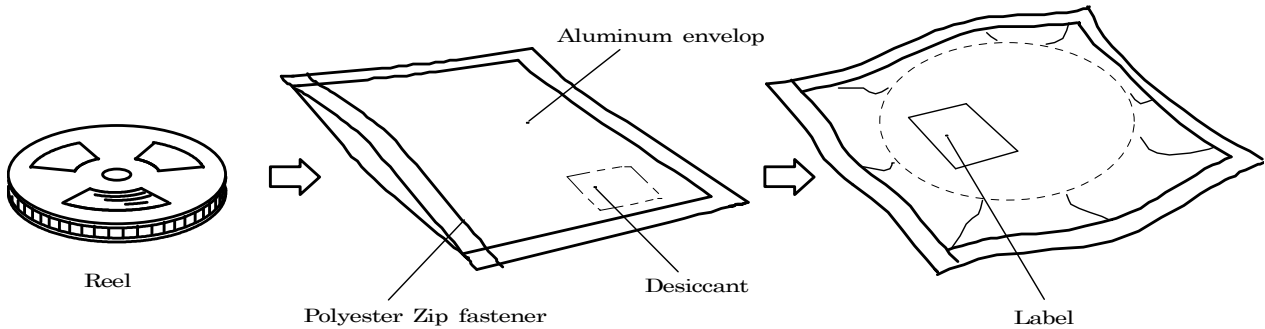

Moisture/Reflow sensitivity classification  
IPC/JEDEC J-STD-020C:Level 1.

8-2. Storage

To prevent moisture absorption, it is strongly recommended that reels (in bulk or taped) should be stored in the dry box (or the desiccator) with a desiccant as the appropriate storage place. If not, the following is needed.

- Temperature: <30 °C
- Humidity: <85%RH

The devices should be mounted as soon as possible after unpacking. If you store the unpacked reels, please store them in the dry box or seal them into the envelop again.

8-3. Baking

If the devices have been stored in the above storage condition (8-2.Storage) over 1year, it should be baked under the following conditions.

- Baking conditions: 60°C×12 hours or more (reeled one)
- 100°C×48 minutes or more (loose one)

			Approved	Checked	Drawn	Symbol	CITILIGHT	
						Name	CL-773F-CW18K2-SDW	
						Drawing No		
Mark	Date	Description	APPRO.					CITIZEN ELECTRONICS CO.,LTD.



9. Precautions

9-1. Soldering

(1) Manual soldering

- 1) Solder of 96.5Sn 3Ag 0.5Cu is recommended.
  - 2) Before soldering every time, make baking to units. By manual soldering, it is the possibility of crack due to the moisture absorption in the resin portion.
  - 3) Use a soldering iron of 25W or smaller. Adjust the temperature of the soldering iron below 350°C.
  - 4) Force or stress must not be applied to the resin portion while soldering.
  - 5) Finish soldering within 3 seconds.
  - 6) Handle the devices only after temperature is cooled down.
- Note) Manual Hot Gas Soldering is not recommended.

(2) Reflow soldering

- 1) Following soldering paste is recommended  
 Melting temperature: 216 ~ 220°C.  
 Composition: 96.5Sn 3Ag 0.5Cu
- 2) The temperature profile at the top surface of the parts is recommended as shown below.
- 3) It is requested that products should be handled after their temperature has dropped down to the normal room temperature

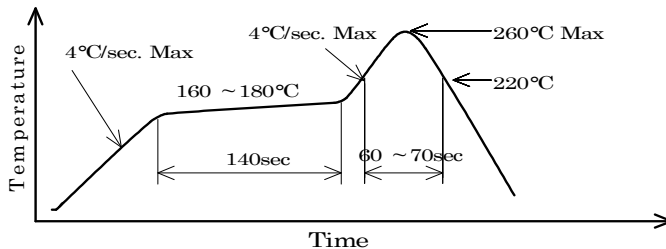

9-2. Washing

- (1) When washing after soldering is needed, following conditions are requested.
  - a) Washing solvent: Pure Water
  - b) Temperature, time: 50°C or less × 30 seconds max. or 30°C or less × 3 minutes max.
  - c) Ultrasonic washing: 300W or less

9-3. Other directions

- (1) It is requested to avoid any stress added to the resin portion while it is heated.
- (2) It is requested to avoid any friction by sharp metal nail etc. to the resin portion.

			Approved	Checked	Drawn	Symbol	CITILIGHT
						Name	CL-773F-CW18K2-SDW
						Drawing No	
Mark	Date	Description	Appro.	CITIZEN ELECTRONICS CO.,LTD.			

10. Designing precautions

- (1) The current limiting resistor should be placed in the circuit so that is driven within its rating. Also avoid reverse voltage (over-current) applied instantaneously when ON or OFF.
- (2) When pulse driving current is applied, average current consumption should be within the rating. Also avoid reverse voltage applied when put off.
- (3) Recommended soldering pattern

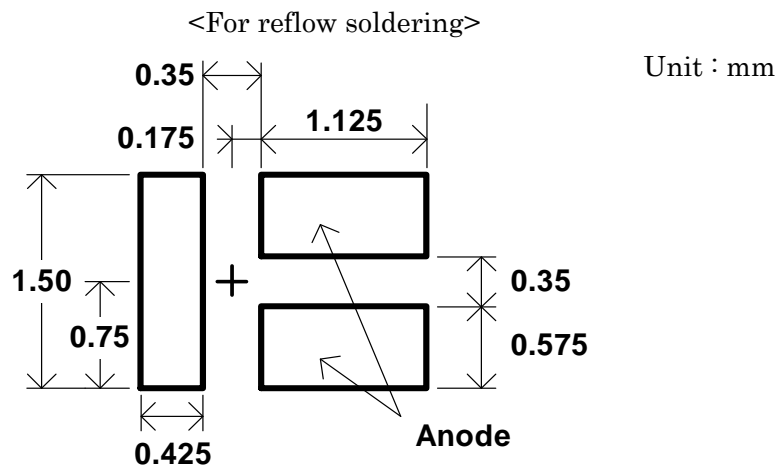

The above dimensions are not the one which guarantee the performance of mountability. The use of the above pattern is recommended to use after deep study at your site.

- (4) When assembling the circuit board into the finished products, care must be taken to avoid the component parts from touching other parts.
- (5) When using multiple LEDs, it is required to connect a current limiting resistor on each path which the current flows to the LEDs.

(ex-1)

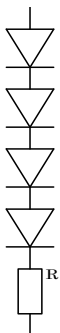

(ex-2)

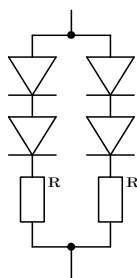

(ex-3)

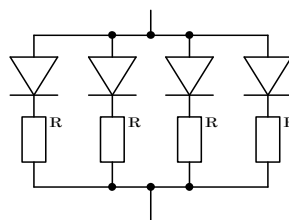

			Approved	Checked	Drawn	Symbol	CITILIGHT
						Name	CL-773F-CW18K2-SDW
						Drawing No	
Mark	Date	Description	Appr.	CITIZEN ELECTRONICS CO.,LTD.			