

FEATURES

- 15 dB Gain
- Wide Bandwidth: 50 MHz to 1 GHz
- High Linearity : +64 dBmV IIP3 (+8 V supply)
- Low Distortion
- Low Noise Figure: 2.0 dB
- Single +4 V to +8 V Supply
- SOIC-16 and SOT-89 Package Options
- RoHS Compliant Package

APPLICATIONS

- CATV Drop Amplifier
- Low noise amplifier for CATV Set-Top Boxes
- Home gateways
- Post Amp for RF overlay in FTTH/RFOG ONUs

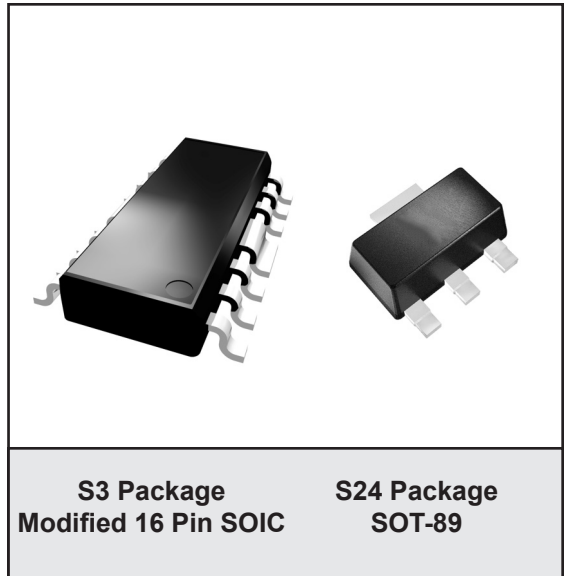

PRODUCT DESCRIPTION

The ADA10000 is a monolithic IC intended for use in applications requiring high linearity, such as Cellular Telephone Base Station Driver Amplifiers, CATV Fiber Receiver and Distribution Amplifiers, and CATV Drop

Amplifiers. Offered in both a modified 16 lead SOIC package and SOT-89 package, it is well suited for use in amplifiers where small size, reduced component count, and high reliability are important.

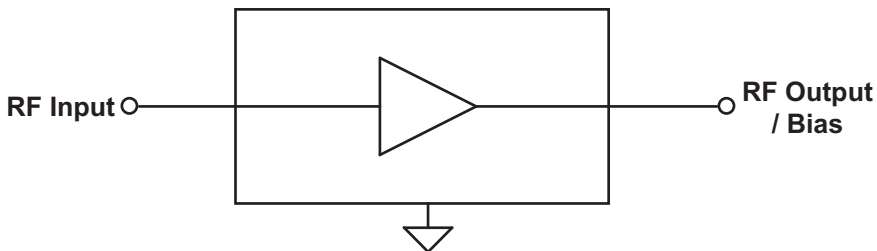

Figure 1: Block Diagram

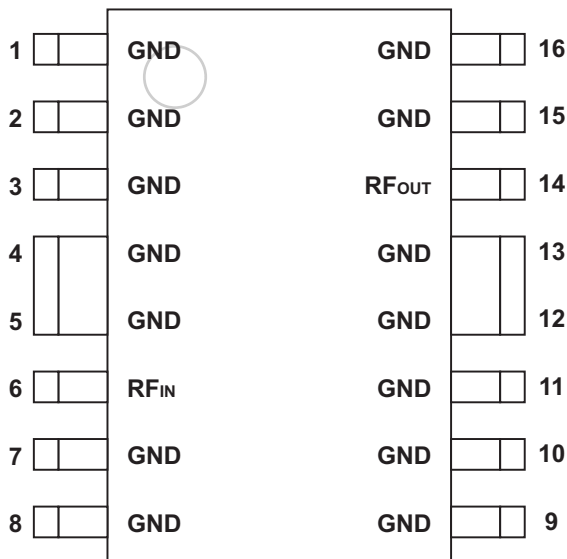

Figure 2: Pinout - S3 Package

Table 1: Pin Description - S3 Package

PIN	NAME	DESCRIPTION	PIN	NAME	DESCRIPTION
1	GND	Ground	16	GND	Ground
2	GND	Ground	15	GND	Ground
3	GND	Ground	14	RF _{OUT}	RF Output / Bias
4	GND	Ground	13	GND	Ground
5	GND	Ground	12	GND	Ground
6	RF _{IN}	RF Input	11	GND	Ground
7	GND	Ground	10	GND	Ground
8	GND	Ground	9	GND	Ground

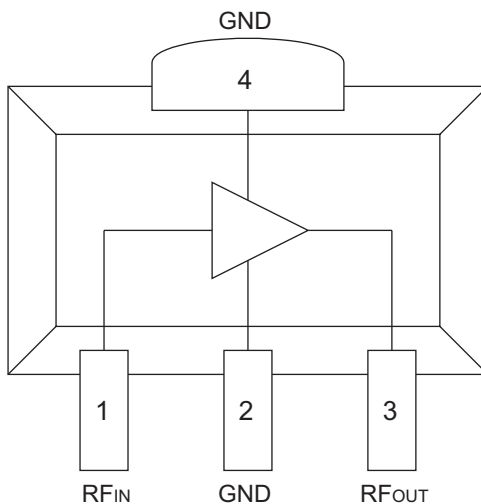

Figure 3: Pinout - S24 Package

Table 2: Pin Description - S24 Package

PIN	NAME	DESCRIPTION
1	RF _{IN}	RF Input
2	GND	Ground
3	RF _{OUT}	RF Output / Bias
4	GND	Ground

ELECTRICAL CHARACTERISTICS

Table 3: Absolute Minimum and Maximum Ratings

PARAMETER	MIN	MAX	UNIT
Supply (S3 package: pin 14) (S24 package: pin 3)	0	+12	VDC
RF Power at Input ⁽¹⁾ (S3 package: pin 6) (S24 package: pin 1)	-	+59	dBmV
Storage Temperature	-65	+150	°C

Stresses in excess of the absolute ratings may cause permanent damage. Functional operation is not implied under these conditions. Exposure to absolute ratings for extended periods of time may adversely affect reliability.

Notes:

(1) RF input pin must be AC-coupled. No DC external bias should be applied.

Table 4: Operating Ranges

PARAMETER	MIN	TYP	MAX	UNIT
RF Input / Output Frequency	50	-	1000	MHz
Supply Voltage (V_{DD})	+4	+8	+9	VDC
Case Temperature	-40	-	+85 ⁽¹⁾	°C

The device may be operated safely over these conditions; however, parametric performance is guaranteed only over the conditions defined in the electrical specifications.

Notes:

(1) Median time to failure will degrade above this temperature.

Table 5: Electrical Specifications
 (T_A = +25 °C, V_{DD} = +8 VDC, 75 Ω system, see Figures 4 and 5)

PARAMETER	MIN	TYP	MAX	UNIT	COMMENT
CSO ⁽¹⁾ / CSO ⁽²⁾	60 / 62	-	-	dBc	
CTB ⁽¹⁾ / CTB ⁽²⁾	65 / 74	-	-	dBc	
Gain	14	15	-	dB	
Noise Figure	-	2.0	3.5	dB	
2nd Order Input Intercept Point (IIP2) ⁽³⁾	+77	+83	-	dBmV	
3rd Order Input Intercept Point (IIP3) ⁽³⁾	+61	+64	-	dBmV	
Thermal Resistance	-	-	35 20	°C/W	S3 package S24 package
Current Consumption ⁽⁴⁾	50	-	150	mA	

Notes:

(1) 160 channels, +17 dBmV per channel (measured at input), 6 MHz channel spacing.

(2) 80 channels, +19 dBmV per channel (measured at input), 6 MHz channel spacing.

(3) Two tones, -39 dBmV per tone at input.

(4) The device can be operated at reduced supply voltages from 4 V to 8 V for lower power dissipation. Refer to Figures 7, 8, 13, and 16 for performance variation with supply voltage.

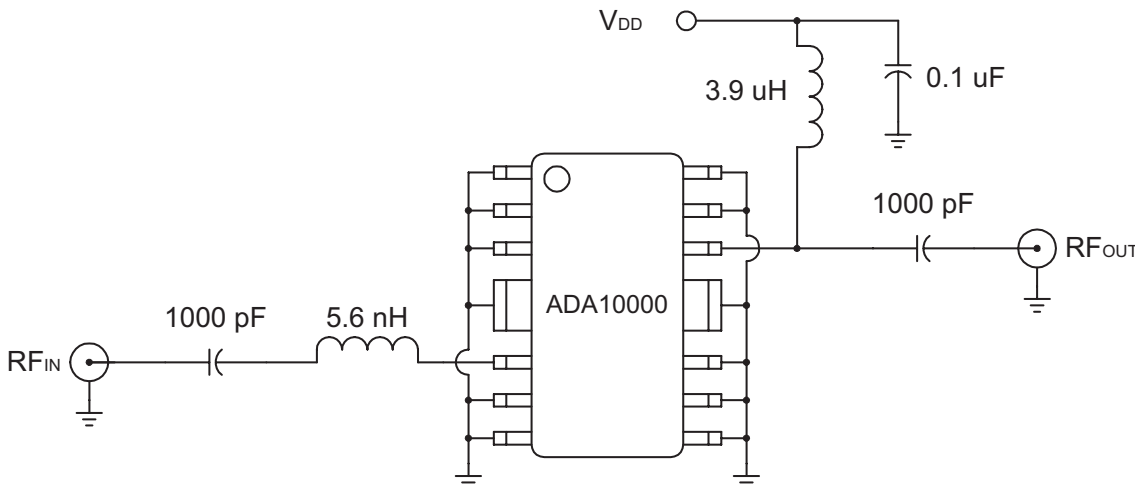

Figure 4: Standard Test/Application Circuit - S3 Package Device (75 Ω terminations)

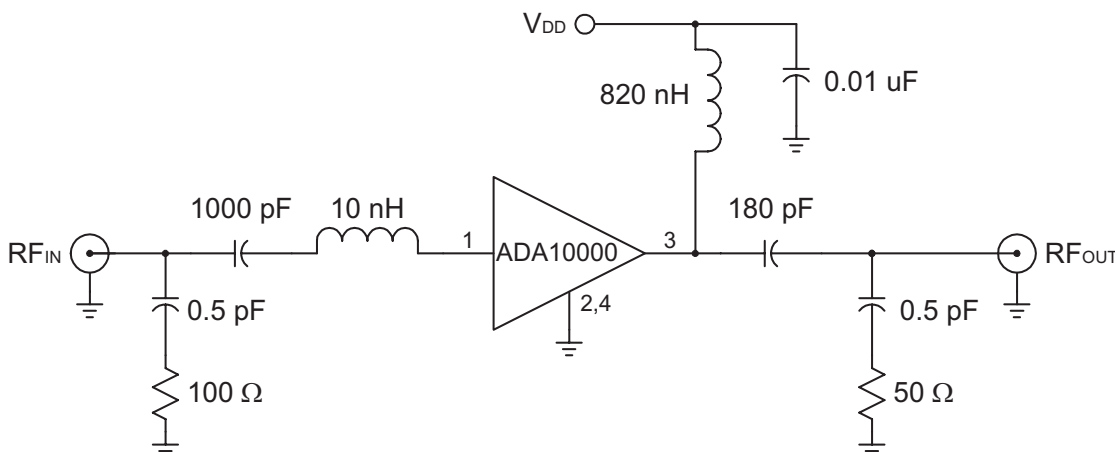

Figure 5: Standard Test/Application Circuit - S24 Package Device (75 Ω terminations)

S3 PACKAGE PERFORMANCE PERFORMANCE DATA: 50 MHz to 1000 MHz

As measured in test circuits shown in Figures 4 and 5.

Figure 6: Gain and Noise Figure vs. Frequency - S3 Package Device
($T_A = +25\text{ }^\circ\text{C}$; $V_{DD} = +8\text{ V}$; $75\ \Omega$ systems)

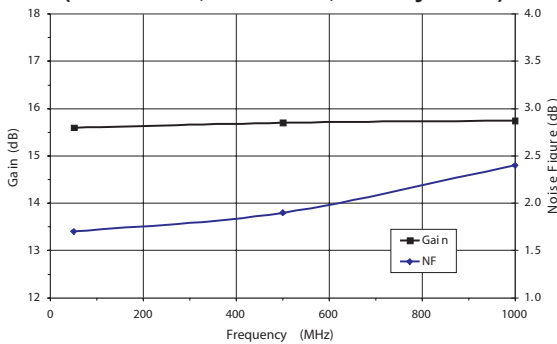

Figure 7: Gain and Noise Figure vs. Supply Voltage - S3 Package Device
($T_A = +25\text{ }^\circ\text{C}$; $f = 500\text{ MHz}$; $75\ \Omega$ systems)

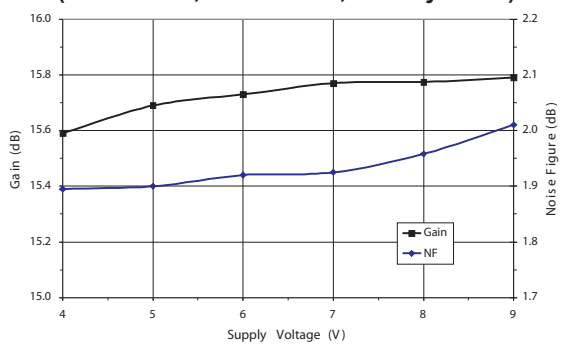
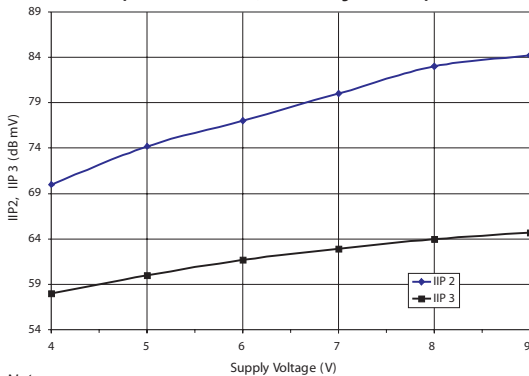

Figure 8: IIP2 and IIP3 vs. Supply Voltage - S3 Package Device
($T_A = +25\text{ }^\circ\text{C}$; $75\ \Omega$ systems)



Notes:

- (1) IIP2 measure at 986.5 MHz; Input = two tones at 55.25 MHz and 931.25 MHz at +39 dBmV.
- (2) IIP3 measured with two tones at the input: 986.5 MHz and 992.5 MHz at +39 dBmV.

Figure 9: Output Power vs. Input Power - S3 Package Device
($T_A = +25\text{ }^\circ\text{C}$; $V_{DD} = +8\text{ V}$; $f = 500\text{ MHz}$; $75\ \Omega$ systems)

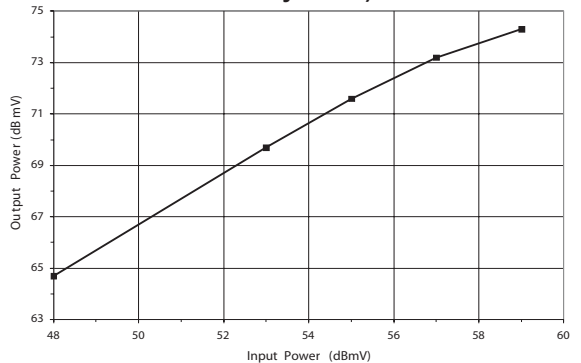

Figure 10: Unmatched Device Input Impedance S3 Package Device
($T_A = +25\text{ }^\circ\text{C}$; $V_{DD} = +8\text{ V}$; $75\ \Omega$ systems)

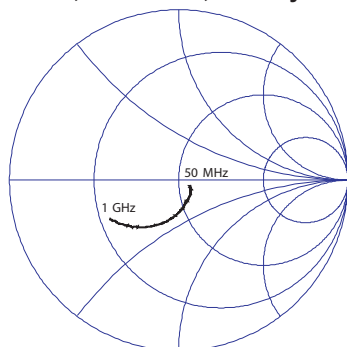
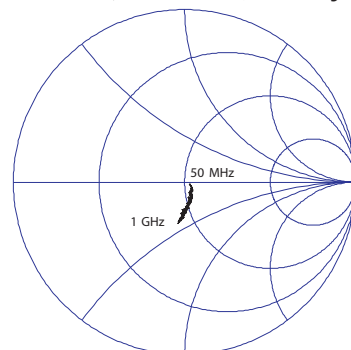

Figure 11: Unmatched Device Output Impedance - S3 Package Device
($T_A = +25\text{ }^\circ\text{C}$; $V_{DD} = +8\text{ V}$; $75\ \Omega$ systems)



Refer to the web site for full 2-port s-parameter data.

S24 (SOT-89) PACKAGE PERFORMANCE PERFORMANCE DATA:

Figure 12: Gain vs. Frequency and Voltage
S24 (SOT-89) Package Device
 (TA = +25 °C; 75 Ω systems)

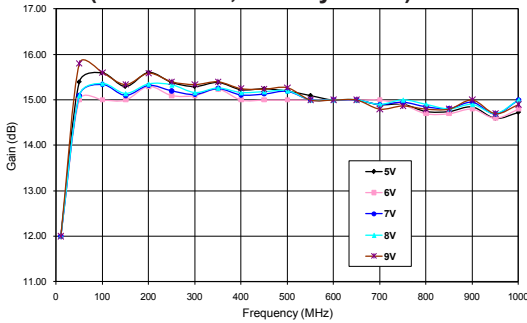

Figure 13: Noise Figure vs. Voltage
S24 (SOT-89) Package Device
 (TA = +25 °C; 75 Ω systems)

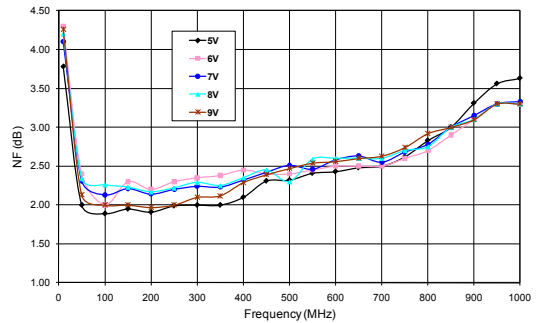

Figure 14: Input Return Loss vs. Frequency - S24 Package Device
 (TA = +25 °C; VDD = +8 V; 75 Ω systems)

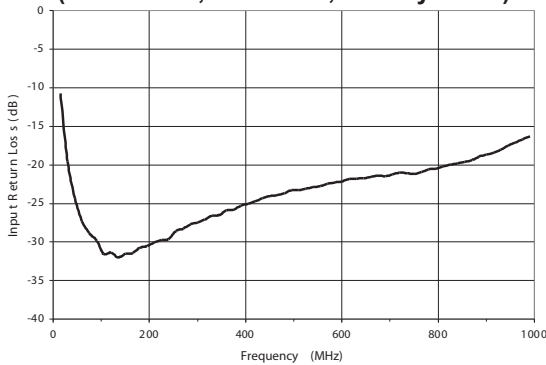

Figure 15: Output Return Loss vs. Frequency - S24 Package Device
 (TA = +25 °C; VDD = +8 V; 75 Ω systems)

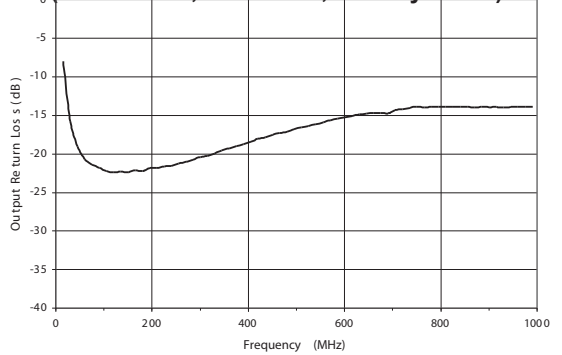

Figure 16: IIP2 and IIP3 vs. Supply Voltage - S24 Package Device
 (TA = +25 °C; 75 Ω systems)

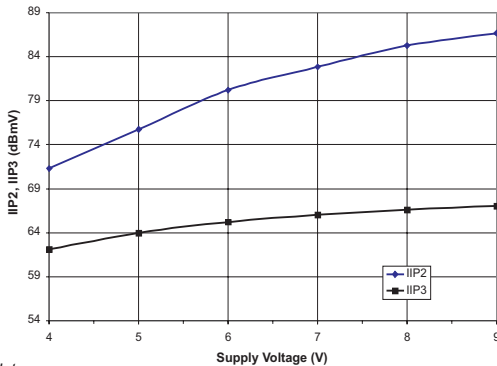
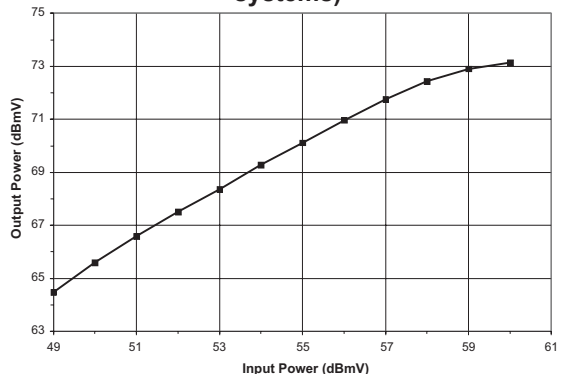

Figure 17: Output Power vs. Input Power - S24 Package Device
 (TA = +25 °C; VDD = +8 V; f = 500 MHz; 75 Ω systems)



Notes:

- (1) IIP2 measure at 986.5 MHz; Input = two tones at 55.25 MHz and 931.25 MHz at +39 dBmV.
- (2) IIP3 measured with two tones at the input: 986.5 MHz and 992.5 MHz at +39 dBmV.

Figure 18: Unmatched Device Input Impedance - S24 Package Device
($T_A = +25\text{ }^\circ\text{C}$; $V_{DD} = +8\text{ V}$; $75\ \Omega$ systems)

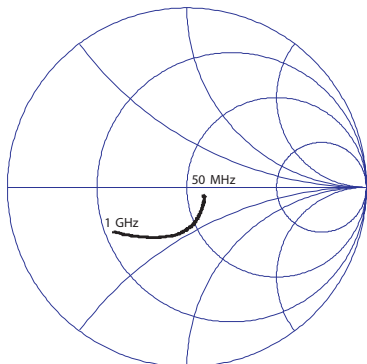
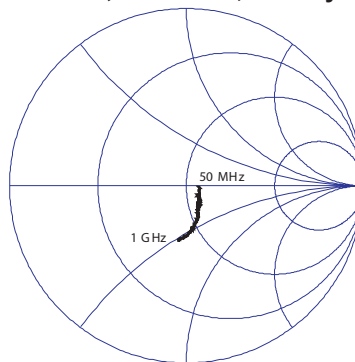

Figure 19: Unmatched Device Output Impedance - S24 Package Device
($T_A = +25\text{ }^\circ\text{C}$; $V_{DD} = +8\text{ V}$; $75\ \Omega$ systems)



Refer to the web site for full 2-port s-parameter data.

50 MHz to 1000 MHz DISTORTION DATA- S24 (SOT-89) PACKAGE DEVICE:
80 Channel Data

Figure 20: CTB vs Frequency and Voltage (80 Flat NTSC Channels; P_{OUT} = +30 dBmV/ch)

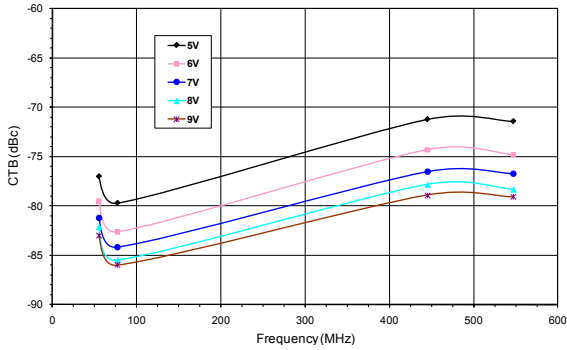

Figure 23: CTB vs Frequency and Output Power (80 Flat NTSC Channels; V_{DD} = +8 V; T_A = +25 °C)

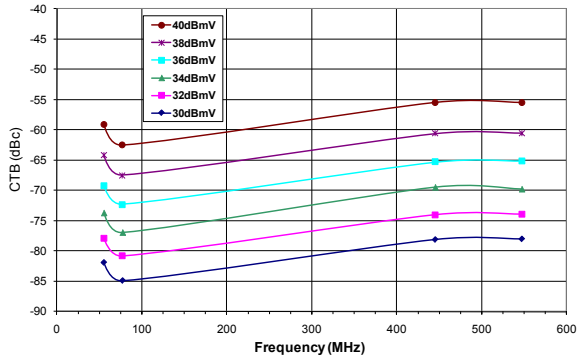

Figure 21: CSO vs Frequency and Voltage (80 Flat NTSC Channels; P_{OUT} = +30 dBmV/ch)

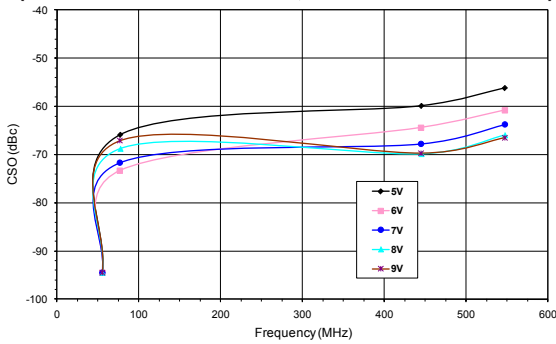

Figure 24: CSO vs Frequency and Output Power (80 Flat NTSC Channels; V_{DD} = +8 V; T_A = +25 °C)

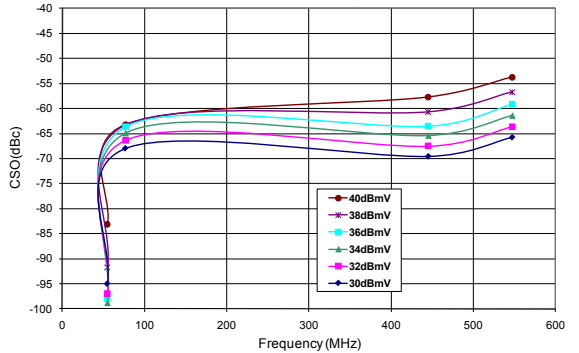

Figure 22: XMOD vs Frequency and Voltage (80 Flat NTSC Channels; P_{OUT} = +30 dBmV/ch)

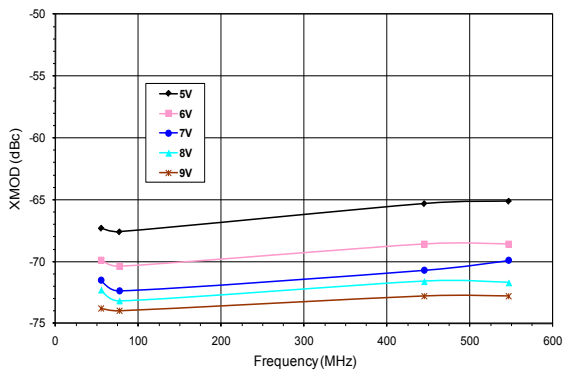
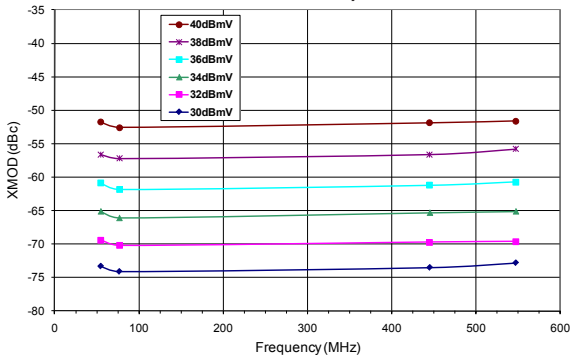

Figure 25: XMOD vs Frequency and Output Power (80 Flat NTSC Channels; V_{DD} = +8 V; T_A = +25 °C)



50 MHz to 1000 MHz DISTORTION DATA- S24 (SOT-89) PACKAGE DEVICE:

110 Channel Data

Figure 26: CTB vs Frequency and Voltage (110 Flat NTSC Channels; P_{OUT} = +30 dBmV/ch)

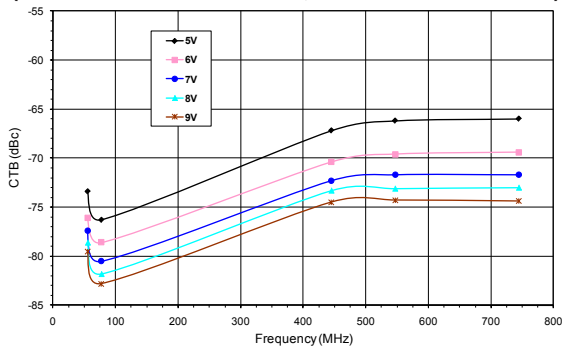

Figure 29: CTB vs Frequency and Output Power (110 Flat NTSC Channels; V_{DD} = +8 V; @ 113 mA; TA = +25 °C)

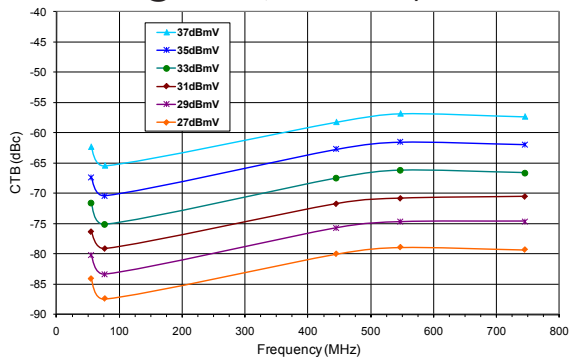

Figure 27: CSO vs Frequency and Voltage (110 Flat NTSC Channels; P_{OUT} = +30 dBmV/ch)

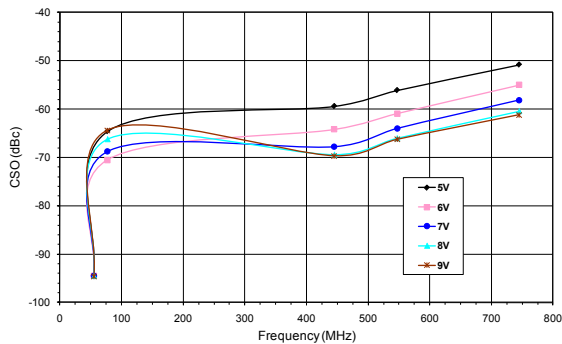

Figure 30: CSO vs Frequency and Output Power (110 Flat NTSC Channels; V_{DD} = +8 V; @ 113 mA; TA = +25 °C)

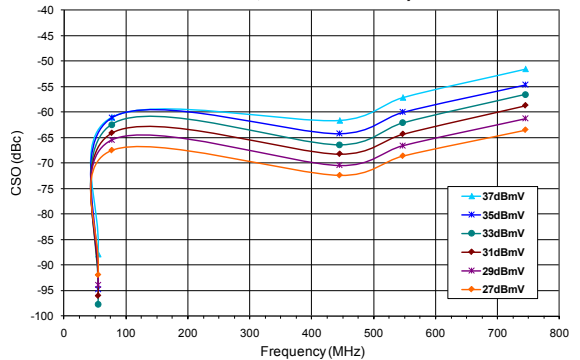

Figure 28: XMOD vs Frequency and Voltage (110 Flat NTSC Channels; P_{OUT} = +30 dBmV/ch)

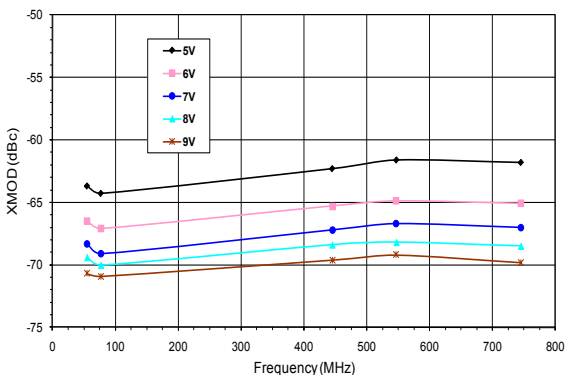
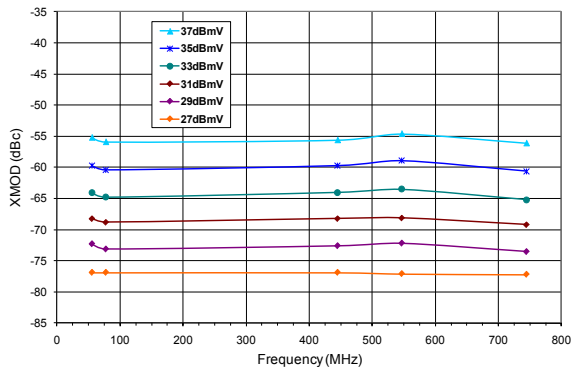

Figure 31: XMOD vs Frequency and Output Power (110 Flat NTSC Channels; V_{DD} = +8 V; @ 113 mA; TA = +25 °C)



50 MHz to 1000 MHz DISTORTION DATA- S24 (SOT-89) PACKAGE DEVICE:

132 Channel Data

Figure 32: CTB vs Frequency and Voltage (132 Flat NTSC Channels; $P_{OUT} = +30$ dBmV/ch)

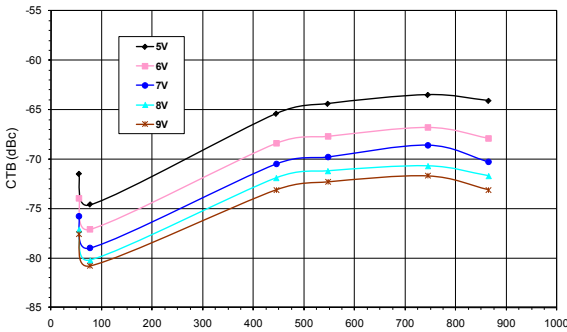

Figure 35: CTB vs Frequency and Output Power (132 Flat NTSC Channels; $V_{DD} = +8$ V; @ 113 mA; $T_A = +25$ °C)

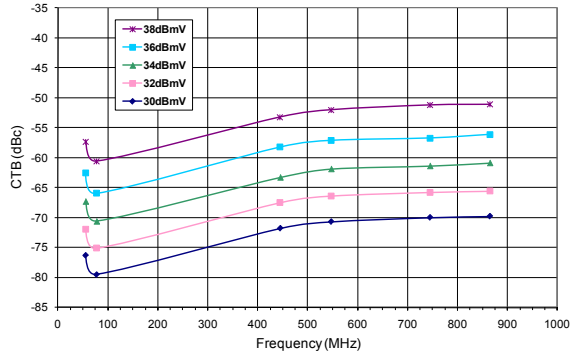

Figure 33: CSO vs Frequency and Voltage (132 Flat NTSC Channels; $P_{OUT} = +30$ dBmV/ch)

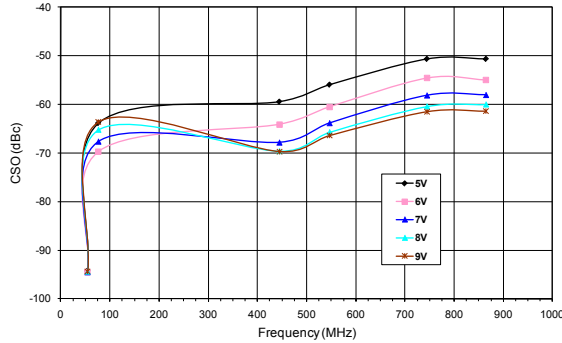

Figure 36: CSO vs Frequency and Output Power (132 Flat NTSC Channels; $V_{DD} = +8$ V; @ 113 mA; $T_A = +25$ °C)

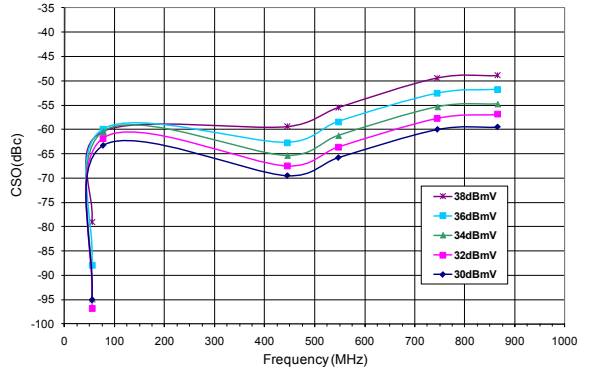

Figure 34: XMOD vs Frequency and Voltage (132 Flat NTSC Channels; $P_{OUT} = +30$ dBmV/ch)

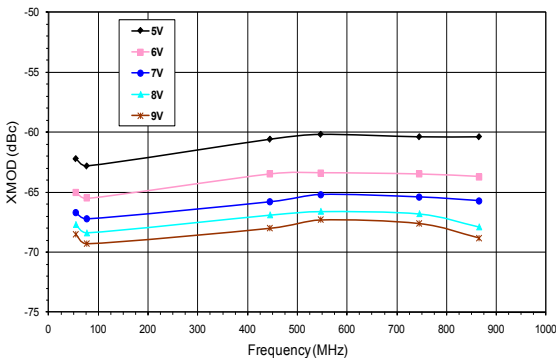
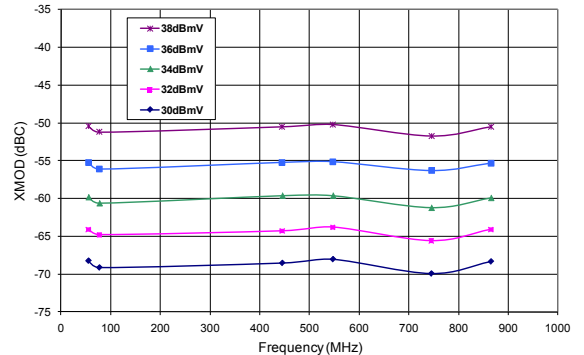

Figure 37: XMOD vs Frequency and Output Power (132 Flat NTSC Channels; $V_{DD} = +8$ V; @ 113 mA; $T_A = +25$ °C)



50 MHz to 1000 MHz DISTORTION DATA- S24 (SOT-89) PACKAGE DEVICE:
155 Channel Data

Figure 38: CTB vs Frequency and Voltage
(155 Flat NTSC Channels; P_{OUT} = +30 dBmV/ch)

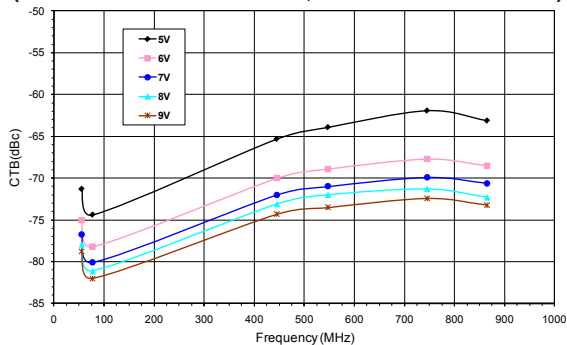

Figure 39: CSO vs Frequency and Voltage
(155 Flat NTSC Channels; P_{OUT} = +30 dBmV/ch)

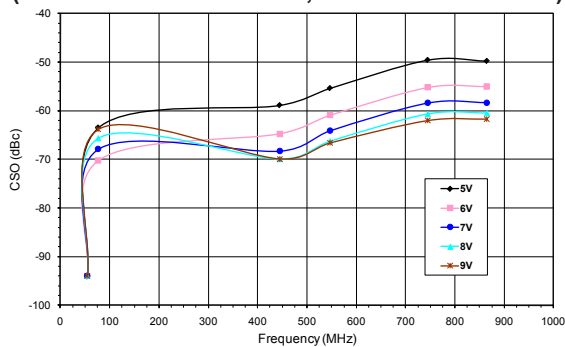
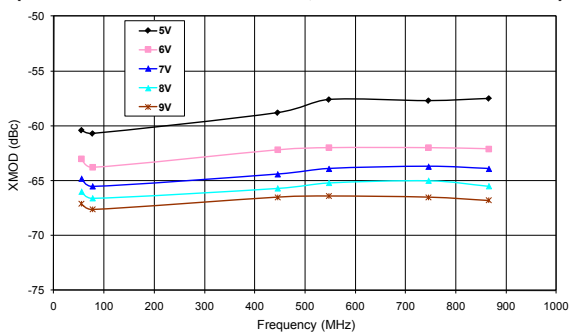

Figure 40: XMOD vs Frequency and Voltage
(155 Flat NTSC Channels; P_{OUT} = +30 dBmV/ch)



PERFORMANCE DATA

P1dB MEASUREMENTS

Figure 41: ADA10000 P1dB vs. Frequency

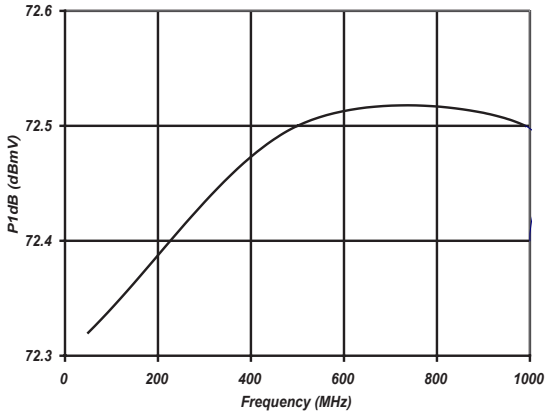

ADA10000 MER MEASUREMENTS

Figure 42: ADA10000 MER – 64 QAM @ 85 MHz

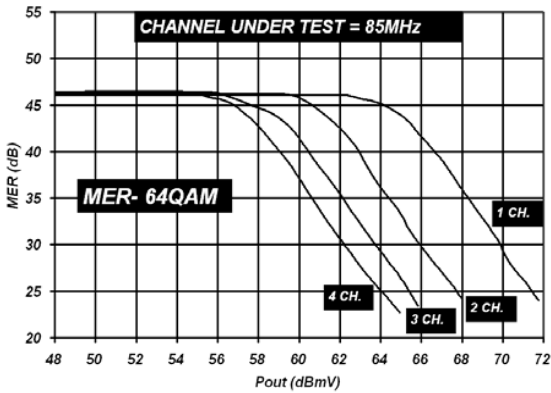

Figure 43: ADA10000 MER – 64 QAM @ 85 MHz

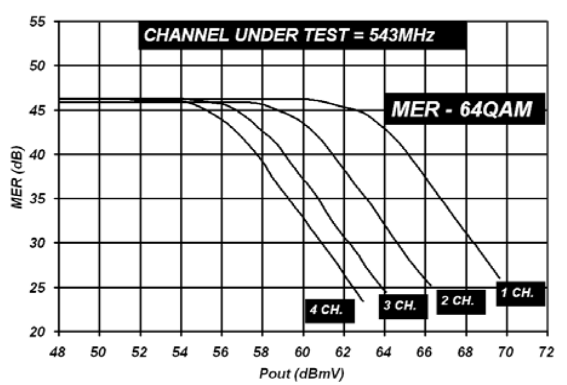

Figure 44: ADA10000 MER – 64 QAM @ 987 MHz

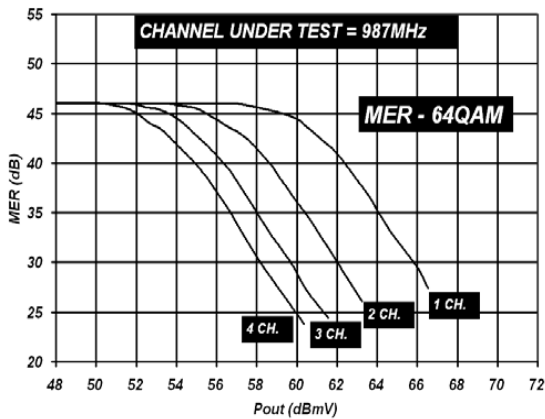

Figure 45: ADA10000 MER – 256 QAM @ 85 MHz

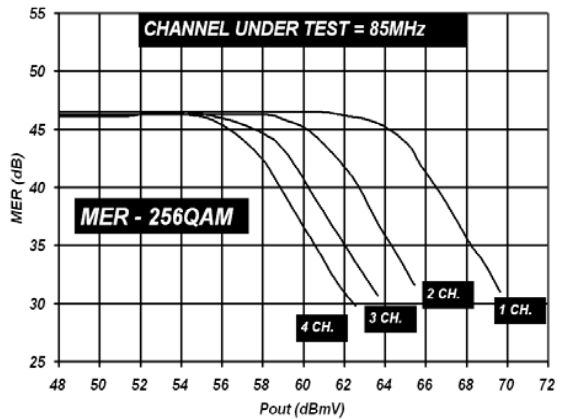

Figure 46: ADA10000 MER – 256 QAM @ 543 MHz

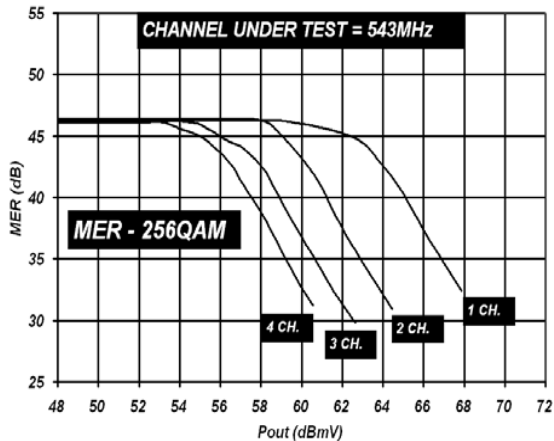
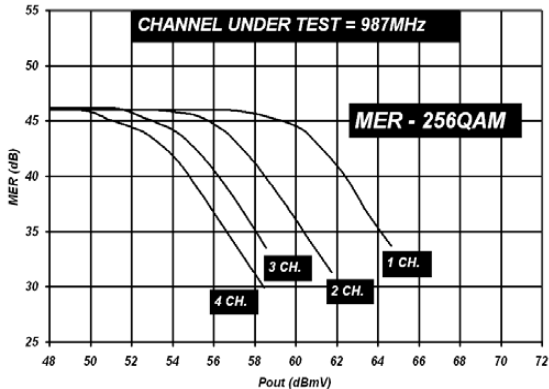

Figure 47: ADA10000 MER – 256 QAM @ 987 MHz



LOW FREQUENCY PERFORMANCE DATA: 5 MHz to 200 MHz

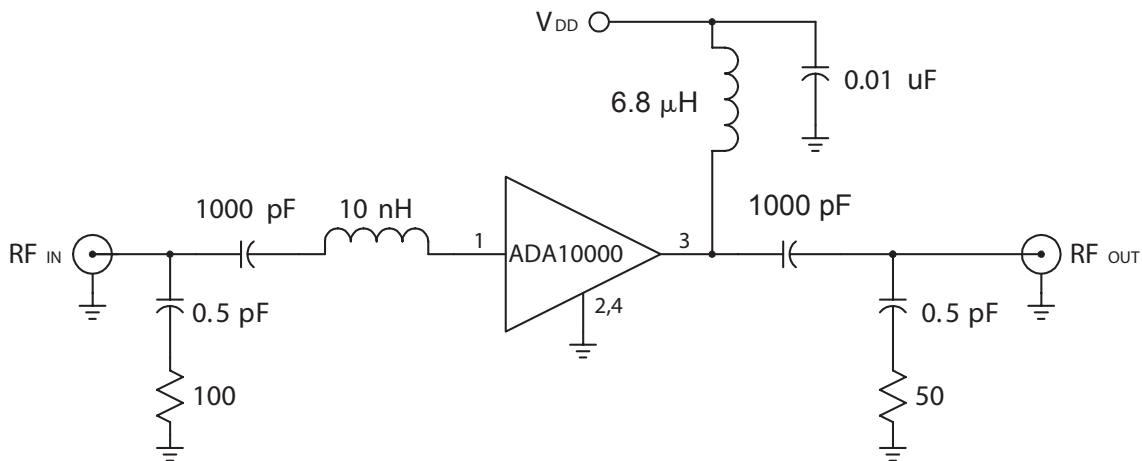

Figure 48: Low Frequency (5 MHz to 200 MHz) Test Application Circuit - S24 Package Device (75 Ω terminations)

Figure 49: Low Frequency Applications
 (See Figure 20)
Input Return Loss vs. Frequency - S24
Package (TA = +25° C; VDD = +8 V; 75 Ω
system)

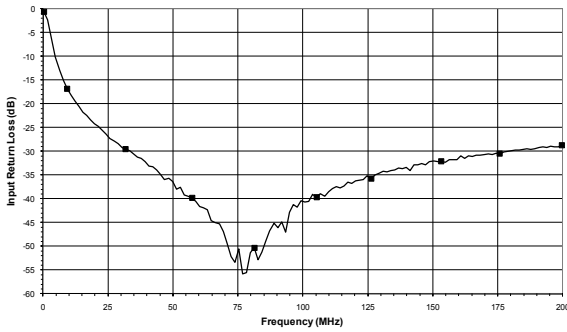

Figure 50: Low Frequency Applications
 (See Figure 20)
Gain vs. Frequency - S24 Package
(TA = +25° C; VDD = +8 V; 75 Ωsystem)

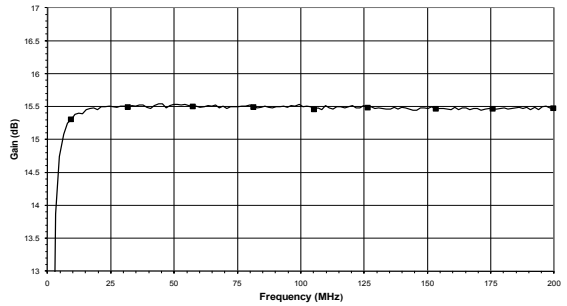

Figure 51: Low Frequency Applications
 (See Figure 20)
Reverse Isolation vs. Frequency - S24 Package
(TA = +25° C; VDD = +8 V; 75 Ω system)

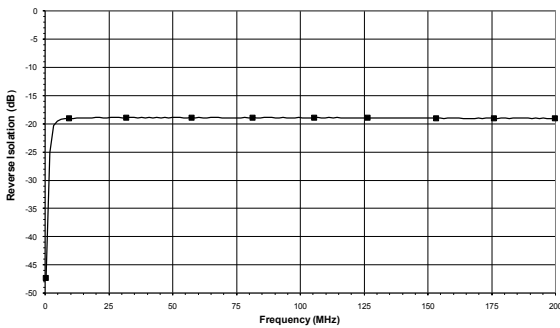

Figure 52: Low Frequency Applications
 (See Figure 20)
Output Return Loss vs. Frequency - S24
Package (TA = +25° C; VDD = +8 V; 75 Ωsystem)

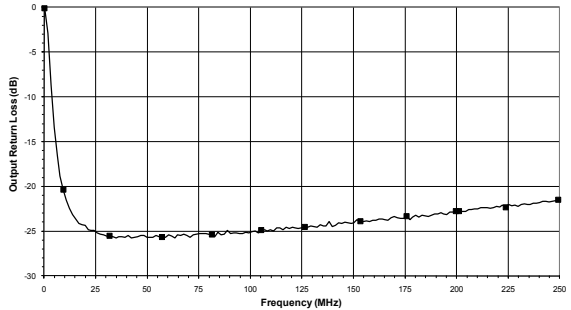
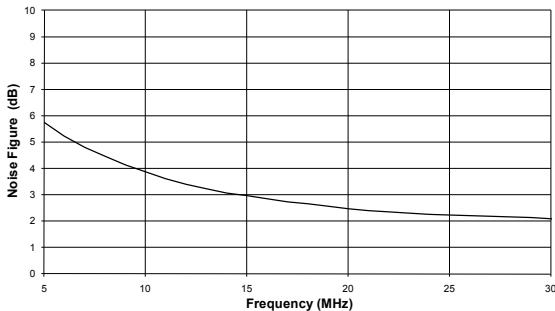
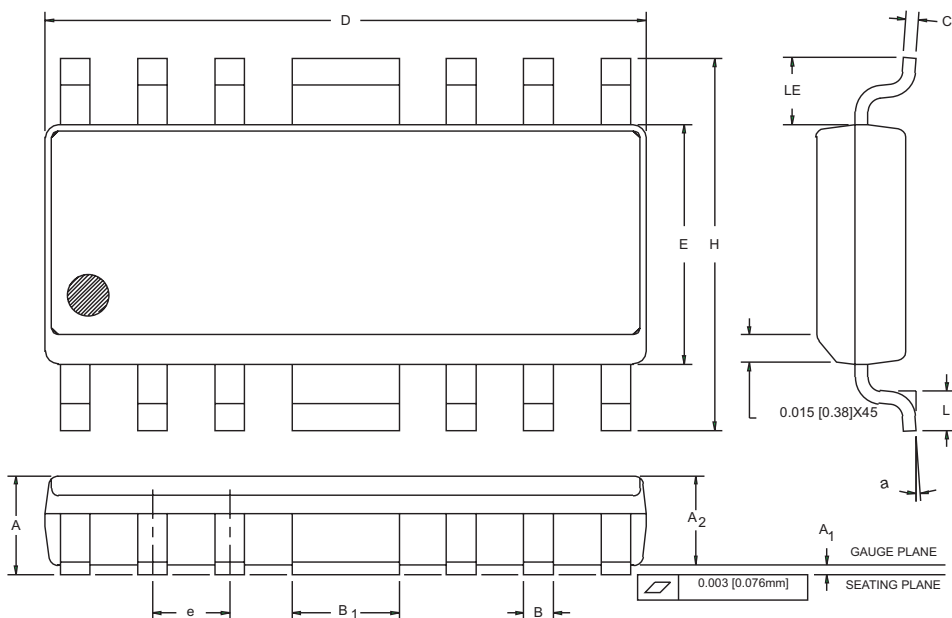

Figure 53: Low Frequency Applications
 (See Figure 20)
Noise Figure vs. Frequency - S24 Package
(TA = +25° C; VDD = +8 V; 75 Ω system)



PACKAGE OUTLINE



S _V , M _B , Q _L	INCHES		MILLIMETERS		NOTE
	MIN.	MAX.	MIN.	MAX.	
A	0.058	0.068	1.47	1.73	
A ₁	0.004	0.010	0.10	0.25	
A ₂	0.055	0.065	1.40	1.65	
B	0.013	0.020	0.33	0.50	
B ₁	0.062	0.070	1.58	1.78	
C	0.008	0.010	0.20	0.25	4
D	0.380	0.400	9.66	10.16	2
E	0.150	0.160	3.81	4.06	3
e	0.050 BSC		1.27 BSC		
H	0.226	0.244	5.74	6.20	
L	0.016	0.040	0.41	1.02	
LE	0.030	—	0.76	—	
a	0	8	0	8	

NOTES:

1. CONTROLLING DIMENSION: INCHES
2. DIMENSION "D" DOES NOT INCLUDE MOLD FLASH, PROTRUSIONS OR GATE BURRS. MOLD FLASH, PROTRUSIONS AND GATE BURRS SHALL NOT EXCEED 0.006 [0.15mm] PER SIDE.
3. DIMENSION "E" DOES NOT INCLUDE INTER-LEAD FLASH OR PROTRUSIONS. INTER-LEAD FLASH AND PROTRUSIONS SHALL NOT EXCEED 0.010 [0.25mm] PER SIDE.
4. LEAD THICKNESS AFTER PLATING TO BE 0.013 [0.33mm] MAXIMUM.

Figure 54: S3 Package Outline - Modified 16 Pin SOIC

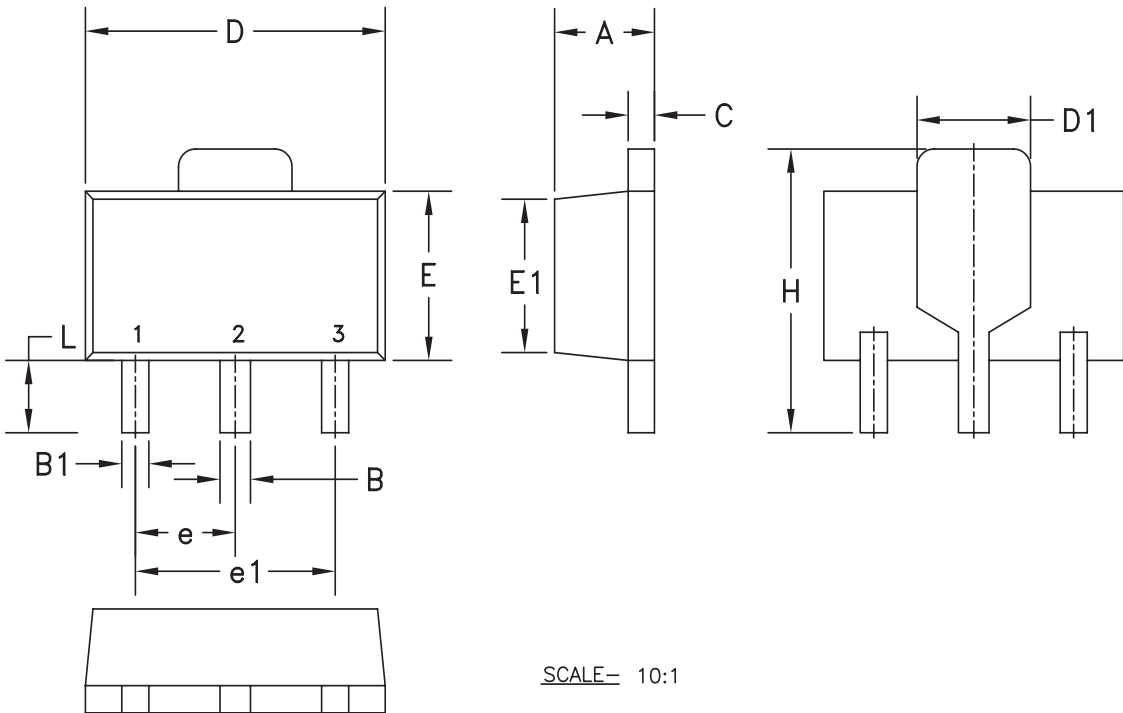

SCALE= 10:1

SYMBOL	INCHES	
	MIN.	MAX.
A	0.055	0.063
B	0.017	0.022
B1	0.014	0.019
C	0.014	0.017
D	0.173	0.181
D1	0.066	0.070
E	0.090	0.099
E1	0.084	0.086
e	0.059 BSC	
e1	0.118 BSC	
H	0.155	0.167
L	0.029	0.041

NOTES:

1. CONTROLLING DIMENSIONS: INCHES.
2. TOP PACKAGE ANGLE IS 9° = 1°/-2° TOLERANCE. PACKAGE ANGLE IS 3° MAX.
3. PACKAGE CORNER RADIUS IS 5 MILS MAX ON ALL CORNERS.
4. SHINNY PACKAGE FINISH ON ALL SIDES EXCEPT TOP SIDE. FINISH MINIMUM MATTE OF 10-14VDI.

Figure 55: S24 Package Outline - SOT-89

ORDERING INFORMATION

ORDER NUMBER	TEMPERATURE RANGE	PACKAGE DESCRIPTION	COMPONENT PACKAGING
ADA10000RS3P1	-40 °C to +85 °C	RoHS Compliant Modified 16 Pin SOIC	3,500 piece Tape and Reel
ADA10000RS24Q1	-40 °C to +85 °C	RoHS Compliant SOT-89 Package	1,000 piece Tape and Reel

NOTES

Copyright © 2016 Skyworks Solutions, Inc. All Rights Reserved.

Information in this document is provided in connection with Skyworks Solutions, Inc. ("Skyworks") products or services. These materials, including the information contained herein, are provided by Skyworks as a service to its customers and may be used for informational purposes only by the customer. Skyworks assumes no responsibility for errors or omissions in these materials or the information contained herein. Skyworks may change its documentation, products, services, specifications or product descriptions at any time, without notice. Skyworks makes no commitment to update the materials or information and shall have no responsibility whatsoever for conflicts, incompatibilities, or other difficulties arising from any future changes.

No license, whether express, implied, by estoppel or otherwise, is granted to any intellectual property rights by this document. Skyworks assumes no liability for any materials, products or information provided hereunder, including the sale, distribution, reproduction or use of Skyworks products, information or materials, except as may be provided in Skyworks Terms and Conditions of Sale.

THE MATERIALS, PRODUCTS AND INFORMATION ARE PROVIDED "AS IS" WITHOUT WARRANTY OF ANY KIND, WHETHER EXPRESS, IMPLIED, STATUTORY, OR OTHERWISE, INCLUDING FITNESS FOR A PARTICULAR PURPOSE OR USE, MERCHANTABILITY, PERFORMANCE, QUALITY OR NON-INFRINGEMENT OF ANY INTELLECTUAL PROPERTY RIGHT; ALL SUCH WARRANTIES ARE HEREBY EXPRESSLY DISCLAIMED. SKYWORKS DOES NOT WARRANT THE ACCURACY OR COMPLETENESS OF THE INFORMATION, TEXT, GRAPHICS OR OTHER ITEMS CONTAINED WITHIN THESE MATERIALS. SKYWORKS SHALL NOT BE LIABLE FOR ANY DAMAGES, INCLUDING BUT NOT LIMITED TO ANY SPECIAL, INDIRECT, INCIDENTAL, STATUTORY, OR CONSEQUENTIAL DAMAGES, INCLUDING WITHOUT LIMITATION, LOST REVENUES OR LOST PROFITS THAT MAY RESULT FROM THE USE OF THE MATERIALS OR INFORMATION, WHETHER OR NOT THE RECIPIENT OF MATERIALS HAS BEEN ADVISED OF THE POSSIBILITY OF SUCH DAMAGE.

Skyworks products are not intended for use in medical, lifesaving or life-sustaining applications, or other equipment in which the failure of the Skyworks products could lead to personal injury, death, physical or environmental damage. Skyworks customers using or selling Skyworks products for use in such applications do so at their own risk and agree to fully indemnify Skyworks for any damages resulting from such improper use or sale.

Customers are responsible for their products and applications using Skyworks products, which may deviate from published specifications as a result of design defects, errors, or operation of products outside of published parameters or design specifications.

Customers should include design and operating safeguards to minimize these and other risks. Skyworks assumes no liability for applications assistance, customer product design, or damage to any equipment resulting from the use of Skyworks products outside of stated published specifications or parameters.

Skyworks and the Skyworks symbol are trademarks or registered trademarks of Skyworks Solutions, Inc., in the United States and other countries. Third-party brands and names are for identification purposes only, and are the property of their respective owners. Additional information, including relevant terms and conditions, posted at www.skyworksinc.com, are incorporated by reference.

Skyworks Solutions, Inc.

Phone [781] 376-3000 • Fax [781] 376-3100 • sales@skyworksinc.com • www.skyworksinc.com

Skyworks Proprietary and Confidential information • Products and Product Information are Subject to Change Without Notice