

DATA SHEET

SKY16406-381LF: 2.2 to 2.8 GHz Two-Way, 0 Degrees Power Divider

Applications

- TD-LTE systems
- Satellite communications
- 2.4 GHz ISM band

Features

- Low insertion loss: 0.3 dB @ 2.5 GHz
- High isolation: >25 dB @ 2.5 GHz
- Return loss: 25 dB typical @ 2.5 GHz
- Miniature DFN (6-pin, 1.5 x 2.0 mm) package (MSL1 @ 260 °C per JEDEC J-STD-020)

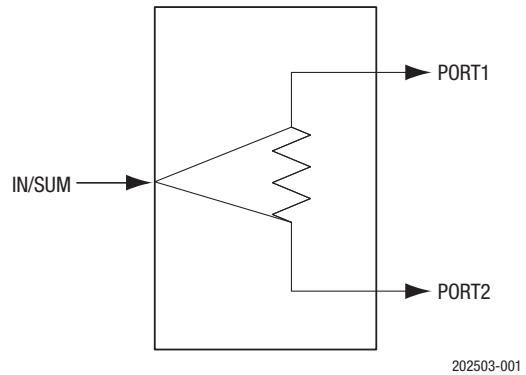

Figure 1. SKY16406-381LF Block Diagram



Skyworks Green™ products are compliant with all applicable legislation and are halogen-free. For additional information, refer to *Skyworks Definition of Green™*, document number SQ04-0074.

Description

The SKY16406-381LF is a two-way, in-phase Wilkinson-style pHEMT power splitter/combiner. The device is optimized for performance in the 2.2 to 2.8 GHz band. The monolithic circuitry offers low insertion loss, high isolation, and exceptional phase/amplitude balance between ports.

The SKY16406-381LF is manufactured in a miniature, 1.5 x 2.0 mm, 6-pin Dual Flat No-Lead (DFN) package. A functional block diagram is shown in Figure 1. The pin configuration and package are shown in Figure 2. Signal pin assignments and functional pin descriptions are provided in Table 1.

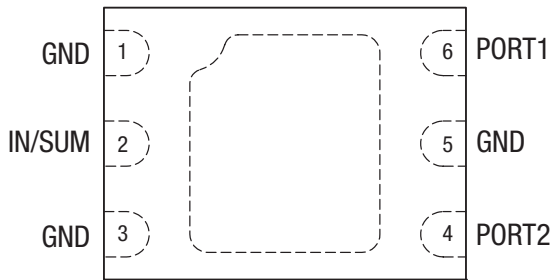

202503-002

Figure 2. SKY16406-381LF Pinout (Top View)

Table 1. SKY16406-381LF Signal Descriptions

Pin	Name	Description	Pin	Name	Description
1	GND	Ground	4	PORT2	RF output, splitter mode, or RF input, combine mode. Not AC coupled.
2	IN/SUM	RF input, splitter mode, or RF output, combine mode. Not AC coupled.	5	GND	Ground
3	GND	Ground	6	PORT1	RF output, splitter mode, or RF input, combine mode. Not AC coupled.

Electrical and Mechanical Specifications

The absolute maximum ratings of the SKY16406-381LF are provided in Table 2. Electrical specifications are provided in Tables 3.

Typical performance characteristics of the SKY16406-381LF are illustrated in Figures 3 through 9.

Table 2. SKY16406-381LF Absolute Maximum Ratings¹

Parameter	Symbol	Min	Typ	Max	Units
RF input power, CW RF signal	P _{IN}			2.5	W
Storage temperature	T _{STG}	-65	+25	+150	°C
Operating temperature	T _A	-55	+25	+105	°C

¹ Exposure to maximum rating conditions for extended periods may reduce device reliability. There is no damage to device with only one parameter set at the limit and all other parameters set at or below their nominal value. Exceeding any of the limits listed here may result in permanent damage to the device.

ESD HANDLING: *Although this device is designed to be as robust as possible, electrostatic discharge (ESD) can damage this device. This device must be protected at all times from ESD when handling or transporting. Static charges may easily produce potentials of several kilovolts on the human body or equipment, which can discharge without detection. Industry-standard ESD handling precautions should be used at all times.*

Table 3. SKY16406-381LF Electrical Specifications¹
(T_A = +25 °C, P_{IN} = 0 dBm, Characteristic Impedance [Z₀] = 50 Ω, @ 2500 MHz, Unless Otherwise Noted)

Parameter	Symbol	Test Condition	Min	Typ	Max	Units
Insertion loss ^{2,3}	IL	PORT1 or PORT2, referenced to IN/SUM port		0.3	0.5	dB
Isolation	Iso	Referenced from PORT1 to PORT2	19	28		dB
Input return loss	IS11I	PORT1 and PORT2, terminated in 50 Ω	18	25		dB
Output return loss	IS22I	PORT1 and PORT2, terminated in 50 Ω	18	25		dB
Amplitude balance	Abal	Referenced from PORT1 to PORT2		±0.1	±0.2	dB
Phase balance	Pbal	Referenced from PORT1 to PORT2		±1.0	±3.5	deg

¹ Performance is guaranteed only under the conditions listed in this Table.
² Above the nominal 3 dB split for PORT1 and PORT2.
³ 0.29 dB has been de-embedded from the measurement for circuit board and connector losses.

Typical Performance Characteristics

($T_A = +25\text{ }^\circ\text{C}$, $P_{IN} = 0\text{ dBm}$, Characteristic Impedance [Z_0] = $50\ \Omega$, @ 2500 MHz, Unless Otherwise Noted)

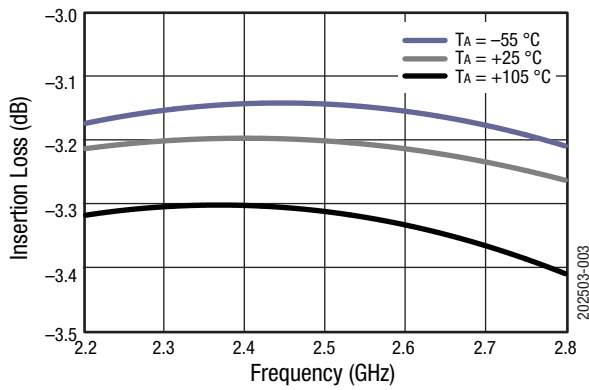

Figure 3. Insertion Loss vs Frequency Over Temperature, Narrow Band (EVB Loss Removed From Measurement)

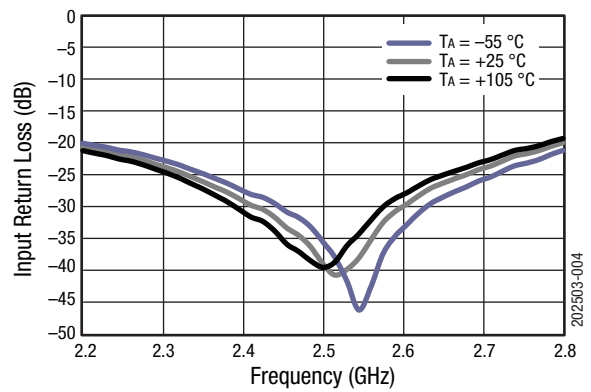

Figure 4. Input Return Loss (IS11, IN/SUM Port) vs Frequency Over Temperature

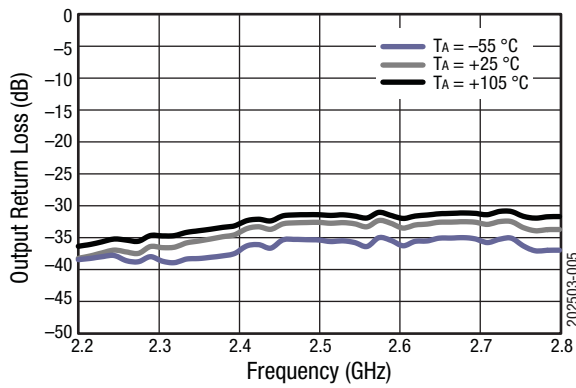

Figure 5. Output Return Loss (IS22I, PORT1) vs Frequency Over Temperature

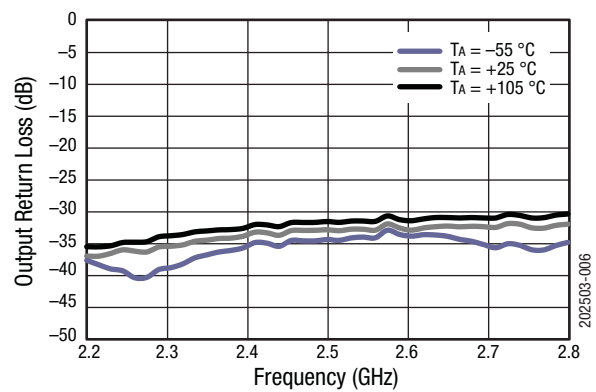

Figure 6. Output Return Loss (IS22I, PORT2) vs Frequency Over Temperature

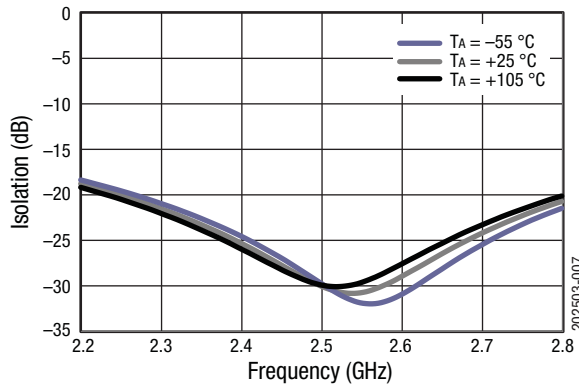

Figure 7. PORT1 to PORT2 Isolation (IN/SUM Port Terminated) vs Frequency Over Temperature

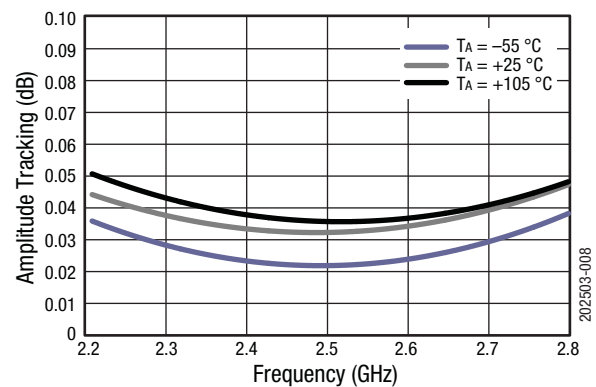

Figure 8. Amplitude Tracking (PORT1 to PORT2) vs Frequency Over Temperature

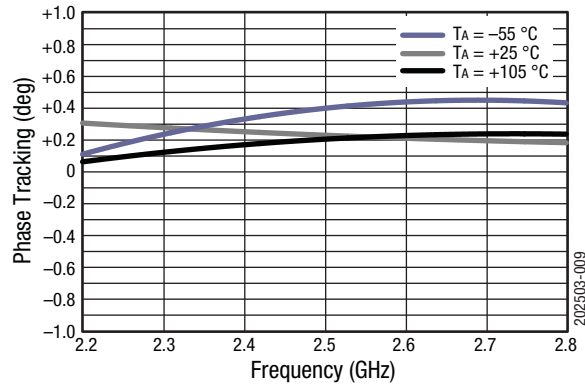

Figure 9. Phase Tracking (PORT1 to PORT2) vs Frequency Over Temperature

Evaluation Board Description

The SKY16406-381LF Evaluation Board is used to test the performance of the SKY16406-381LF LNA.

An assembly drawing for the Evaluation Board is shown in Figure 10. An Evaluation Board schematic diagram is provided in Figure 11.

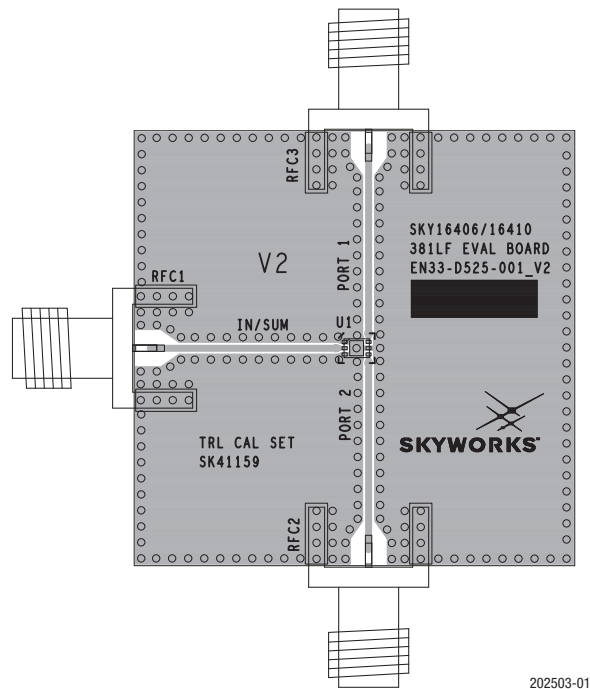

Figure 10. SKY16406-381LF Evaluation Board Assembly Diagram

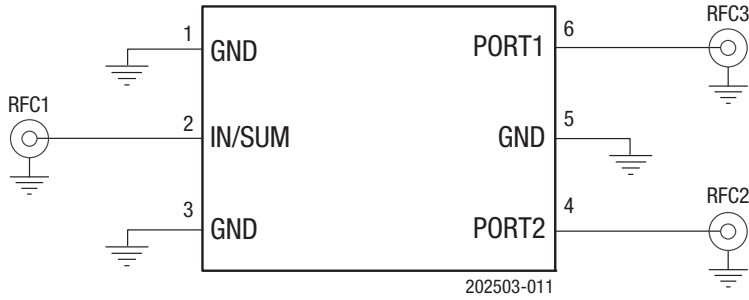

Figure 11. SKY16406-381LF Evaluation Board Schematic

Package Dimensions

The PCB layout footprint for the SKY16406-381LF is provided in Figure 12. Typical part markings are shown in Figure 13. Package dimensions are shown in Figure 14, and tape and reel dimensions are provided in Figure 15.

Package and Handling Information

Instructions on the shipping container label regarding exposure to moisture after the container seal is broken must be followed. Otherwise, problems related to moisture absorption may occur when the part is subjected to high temperature during solder assembly.

The SKY16406-381LF is rated to Moisture Sensitivity Level 1 (MSL1) at 260 °C. It can be used for lead or lead-free soldering. For additional information, refer to the Skyworks Application Note, *Solder Reflow Information*, document number 200164.

Care must be taken when attaching this product, whether it is done manually or in a production solder reflow environment. Production quantities of this product are shipped in a standard tape and reel format.

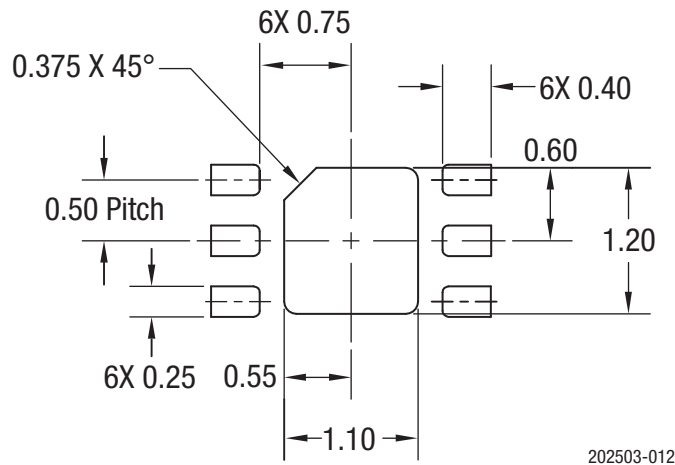

Figure 12. SKY16406-381LF PCB Layout Footprint (Top View)

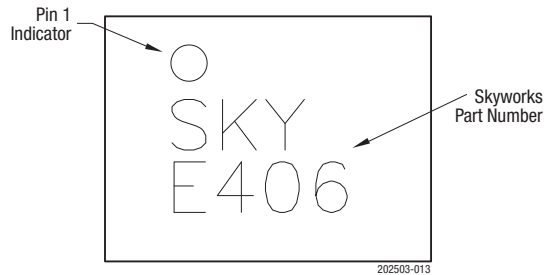
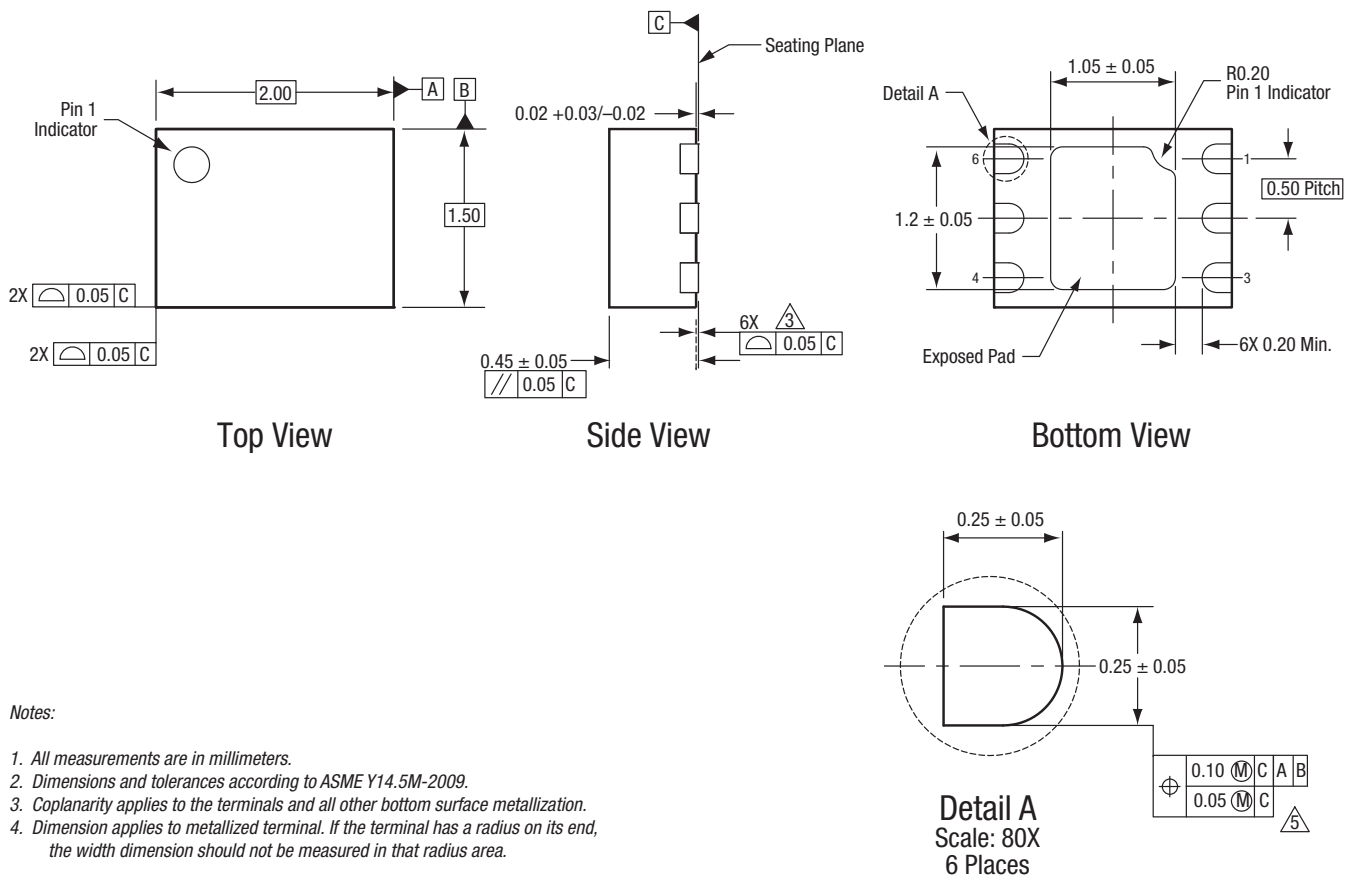

Figure 13. Typical Part Markings (Top View)



Notes:

1. All measurements are in millimeters.
2. Dimensions and tolerances according to ASME Y14.5M-2009.
3. Coplanarity applies to the terminals and all other bottom surface metallization.
4. Dimension applies to metallized terminal. If the terminal has a radius on its end, the width dimension should not be measured in that radius area.

Figure 14. SKY16406-381LF Package Dimensions

202503-014

Ordering Information

Product Description	Product Part Number	Evaluation Board Part Number
SKY16406-381LF: Two-Way Power Divider	SKY16406-381LF	SKY16406-381LF-EVB

Copyright © 2012, 2017 Skyworks Solutions, Inc. All Rights Reserved.

Information in this document is provided in connection with Skyworks Solutions, Inc. (“Skyworks”) products or services. These materials, including the information contained herein, are provided by Skyworks as a service to its customers and may be used for informational purposes only by the customer. Skyworks assumes no responsibility for errors or omissions in these materials or the information contained herein. Skyworks may change its documentation, products, services, specifications or product descriptions at any time, without notice. Skyworks makes no commitment to update the materials or information and shall have no responsibility whatsoever for conflicts, incompatibilities, or other difficulties arising from any future changes.

No license, whether express, implied, by estoppel or otherwise, is granted to any intellectual property rights by this document. Skyworks assumes no liability for any materials, products or information provided hereunder, including the sale, distribution, reproduction or use of Skyworks products, information or materials, except as may be provided in Skyworks Terms and Conditions of Sale.

THE MATERIALS, PRODUCTS AND INFORMATION ARE PROVIDED “AS IS” WITHOUT WARRANTY OF ANY KIND, WHETHER EXPRESS, IMPLIED, STATUTORY, OR OTHERWISE, INCLUDING FITNESS FOR A PARTICULAR PURPOSE OR USE, MERCHANTABILITY, PERFORMANCE, QUALITY OR NON-INFRINGEMENT OF ANY INTELLECTUAL PROPERTY RIGHT; ALL SUCH WARRANTIES ARE HEREBY EXPRESSLY DISCLAIMED. SKYWORKS DOES NOT WARRANT THE ACCURACY OR COMPLETENESS OF THE INFORMATION, TEXT, GRAPHICS OR OTHER ITEMS CONTAINED WITHIN THESE MATERIALS. SKYWORKS SHALL NOT BE LIABLE FOR ANY DAMAGES, INCLUDING BUT NOT LIMITED TO ANY SPECIAL, INDIRECT, INCIDENTAL, STATUTORY, OR CONSEQUENTIAL DAMAGES, INCLUDING WITHOUT LIMITATION, LOST REVENUES OR LOST PROFITS THAT MAY RESULT FROM THE USE OF THE MATERIALS OR INFORMATION, WHETHER OR NOT THE RECIPIENT OF MATERIALS HAS BEEN ADVISED OF THE POSSIBILITY OF SUCH DAMAGE.

Skyworks products are not intended for use in medical, lifesaving or life-sustaining applications, or other equipment in which the failure of the Skyworks products could lead to personal injury, death, physical or environmental damage. Skyworks customers using or selling Skyworks products for use in such applications do so at their own risk and agree to fully indemnify Skyworks for any damages resulting from such improper use or sale.

Customers are responsible for their products and applications using Skyworks products, which may deviate from published specifications as a result of design defects, errors, or operation of products outside of published parameters or design specifications. Customers should include design and operating safeguards to minimize these and other risks. Skyworks assumes no liability for applications assistance, customer product design, or damage to any equipment resulting from the use of Skyworks products outside of stated published specifications or parameters.

Skyworks and the Skyworks symbol are trademarks or registered trademarks of Skyworks Solutions, Inc. or its subsidiaries in the United States and other countries. Third-party brands and names are for identification purposes only, and are the property of their respective owners. Additional information, including relevant terms and conditions, posted at www.skyworksinc.com, are incorporated by reference.