

DESCRIPTION: 975T D-SUB BACKSHELL - 3 WAY

MATERIAL:

- PLASTIC: UL94HB, ABS PLASTIC
- METALIZED: NICKEL OVER COPPER
- 4-40 JACKSCREWS: STEEL, ZINC PLATED
- HOUSING SCREWS: STEEL, ZINC PLATED
- STRAIN RELIEF: STEEL, ZINC PLATED
- STRAIN RELIEF SCREWS: STEEL, ZINC PLATED
- OPERATING TEMP: -55°C TO +120°C

E = MAX CABLE O.D.

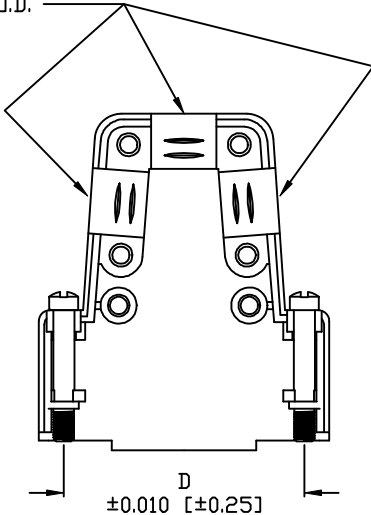
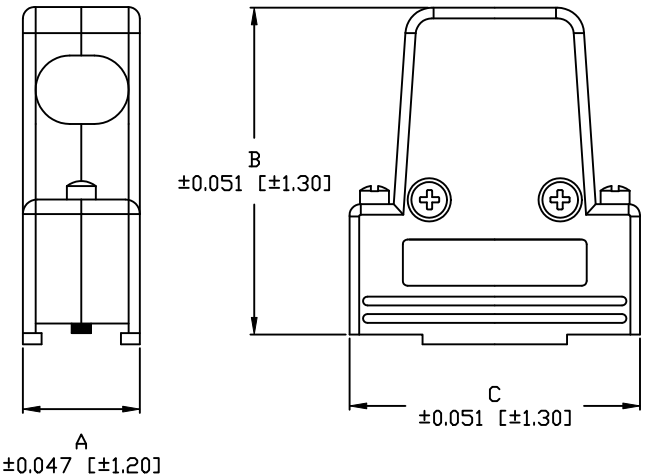

BACKSHELL KIT INCLUDES:

- (2) BACKSHELL HAVLES
- (2) 4-40 JACKSCREWS
- (2) HOUSING SCREWS (self-tapping)
- (2) STRAIN RELIEF CLAMP
- (4) STRAIN RELIEF SCREWS (self-tapping)
- (2) CABLE SLOT SHUT-OFFS

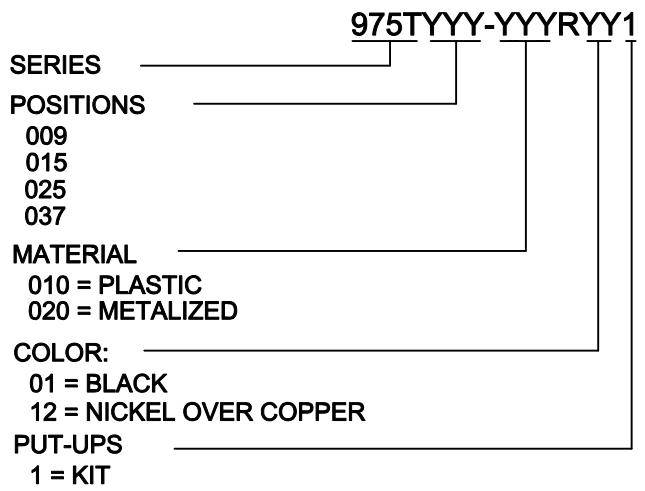
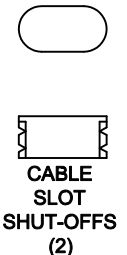
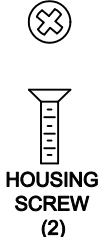
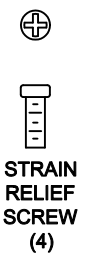
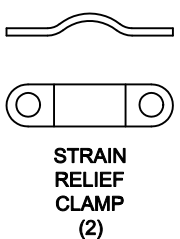
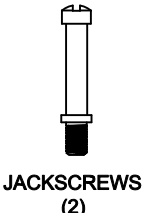

POS.	A	B	C	D	E
9	0.591	1.630	1.221	0.984	0.230
	15.00	41.40	31.00	24.99	5.85
15	0.591	1.780	1.587	1.312	0.340
	15.00	45.20	40.3	33.32	8.63
25	0.591	1.780	2.106	1.852	0.400
	15.00	45.20	53.50	47.04	10.16
37	0.591	1.780	2.756	2.500	0.400
	15.00	45.20	70.00	63.50	10.16

DO NOT SCALE FROM DRAWING

	THESE DRAWINGS AND SPECIFICATIONS ARE THE PROPERTY OF NorComp AND SHALL NOT BE REPRODUCED, COPIED OR USED AS THE BASIS FOR THE MANUFACTURE OF SALE OF APPARATUS WITHOUT WRITTEN PERMISSION.		DRAWN: M. SIGMON	DATE: 03-17-11
			CHECKED:	DATE:
<h1>NorComp</h1>		SCALE: 1:1	SHEET 1 OF 1	REV 2
		DWG NO. 975TYYY-YYYRYY1		

RoHS COMPLIANT