

M2 DIN rail mounted electronic timers (22.5 mm)

Relay outputs

- Multi-function or mono-function
- Multi-range (8 ranges)
- Dual-voltage
- 1 changeover 8 A / 250 V
- Display of output states by 2 LEDs
- Wide choice of functions
- Front terminals

Characteristics

Accuracy

Repetition accuracy (with constant parameters)	± 0.5 %
Variation according to 0 • 40 °C	± 3 %
VDE 0435 -20 • 60 °C	± 5 %
Min. control pulse	0.02 s
Maximum reset time by de-energisation	0.100 s
Immunity from micro power cuts	<0.02 s

Output specification

Nominal current	8 A ~ 1 A ~
Nominal voltage	250 V ~
Rated power	2000 VA - 30 W
Maximum admissible current	15 A < 0.01 s
Minimum current	50 mA ~
Electrical life at I max 250 V ~ resistive (cycles)	1.5 • 10 ⁵

Max. permitted number of operations per hour at I max 250 V ~ resistive	360
Mechanical life (operations)	2 x 10 ⁷

Function and use

Display of output state by LED	output in operation	Green LED
	power on	Red LED

Voltage variation	± 15 % Un 127 V-10% 240 V+10%
-------------------	----------------------------------

Maximum absorbed power	1.5 W / 24 V 5 VA / 110-127 V 10 VA / 220-240 V
------------------------	---

Temperature limits	Use Stored	-20 °C + 60 °C -30 °C + 70 °C
--------------------	---------------	----------------------------------

Insulation according to standard VDE 0110 - IEC 255 Group C	250 V ~
---	---------

Protection class according to NFC 20010 - IEC 529 - DIN 40050	IP40
---	------

Conformity to standards IEC 255 VDE 0435-2021	•
---	---

Protection from voltage surge (in joules)	2
---	---

Connection: by terminal blocks with cable guide and front-access captive screws	•
---	---

Terminal capacity : multi or single wire 1 or 2 leads	2.5 mm ²
---	---------------------

Mounting on symmetrical DIN rail 35 mm EN 50022	•
---	---

Weight (g)	110
------------	-----

Products currently being replaced by the TR range

Timing

Types

Part numbers (and voltages)

24 V ~ / 110 • 127 V 50 • 60Hz
24 V ~ / 220 • 240 V 50 • 60Hz
24 V ~ / 50 • 60Hz
110 • 127 V 50 • 60Hz
220 • 240 V 50 • 60Hz
N.B. : For 48 V ~ supply
Additional resistor : 560 Ω 2W / 24 V ~

Functions

Relay outputs

Nominal current

Timing ranges (8 available options)

0.1 s to 1 s	0.4 min to 4 min	1 h to 10 h
1 s to 10 s	1 min to 10 min	6 h to 60 h
6 s to 60 s	6 min to 60 min	

Function diagrams

Terminal connections

- A1 - A2 : Supply
- A3 : Bridge (A2 - A3) for 24V supply
- B1 - B2 : Control contact
- 15 - 16 - 18 : Timed output contact
- Galvanic insulation Input-Output



Accessories

Panel adaptor **79 237 806**

Function diagrams

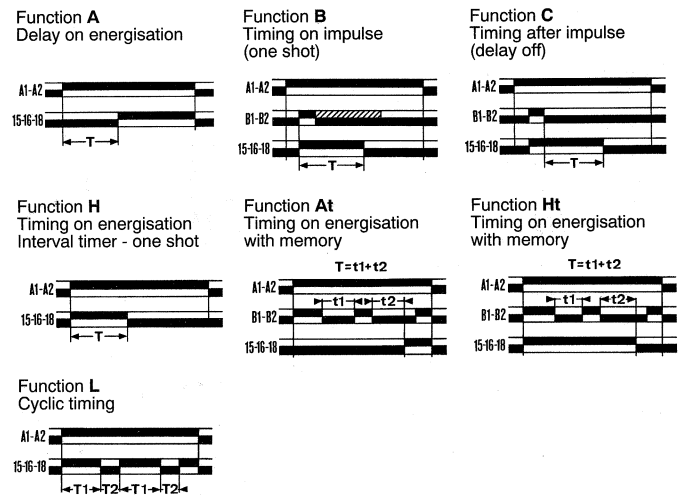

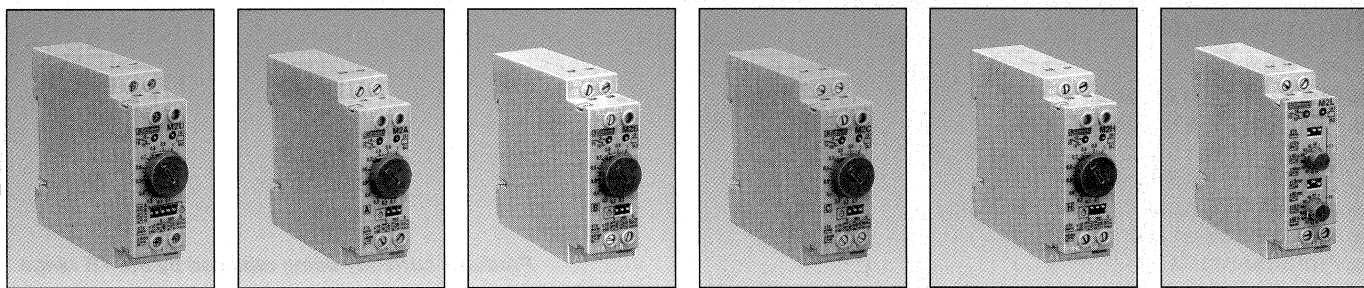

0.1 s • 60 h		0.1 s • 60 h		0.1 s • 60 h		0.1 s • 60 h		0.1 s • 60 h		0.1 s • 60 h	
M2 U		M2 A		M2 B		M2 C		M2 H		M2 L	
88 881 005	—	—	—	—	—	—	—	—	—	88 881 505	—
88 881 006	—	—	—	—	—	—	—	—	—	88 881 506	—
—	—	88 881 100	—	88 881 200	—	88 881 300	—	88 881 400	—	—	—
—	—	88 881 102	—	88 881 202	—	88 881 302	—	88 881 402	—	—	—
—	—	88 881 104	—	88 881 204	—	88 881 304	—	88 881 404	—	—	—
•	•	•	•	•	•	•	•	•	•	•	•

1
2

Multi-function with selection	Mono-function	Mono-function	Mono-function	Mono-function	Mono-function
A B C H At Ht	A	B	C	H	L
1 timed changeover	1 timed changeover	1 timed changeover	1 timed changeover	1 timed changeover	1 timed changeover
8 A ~ 1A ≡	8 A ~ 1A ≡	8 A ~ 1A ≡	8 A ~ 1A ≡	8 A ~ 1A ≡	8 A ~ 1A ≡
•	•	•	•	•	•

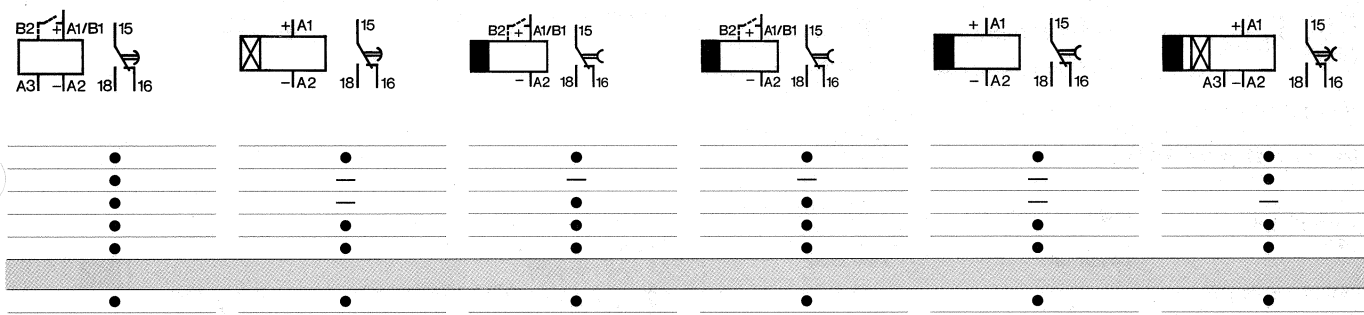

3

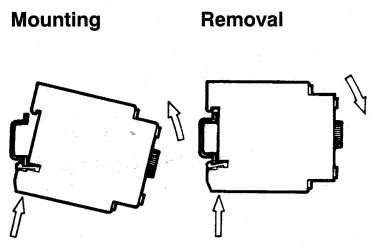
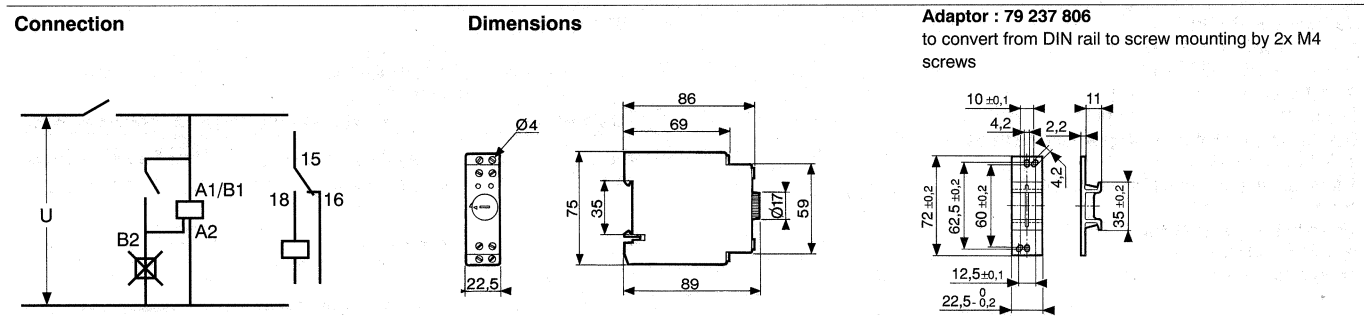

To order, specify :

Standard products, non stocked

1 Type
 2 Part number
 3 Accessory

Example : M2 U electronic timer - 88 881 006 - Panel adaptor 79 237 806

M2 DIN rail mounted electronic timers (22.5 mm)

Relay outputs

- Multi-function or mono-function
- Multi-range (8 ranges)
- Dual-voltage
- 1 changeover 8 A / 250 V
- Display of output states by 2 LEDs
- Wide choice of functions
- Front terminals

Characteristics

Accuracy

Repetition accuracy (with constant parameters)		± 0.5 %
Variation according to	0 • 40 °C	± 3 %
VDE 0435	-20 • 60 °C	± 5 %
Min. control pulse		0.02 s
Maximum reset time by de-energisation		0.100 s
Immunity from micro power cuts		<0.02 s
Minimum time on energisation	Ma - Mb - Mc K	1s 1s 1s 0.30s
Minimum time on de-energisation	Ma - Mb - Mc	0.2s 1s 1s

Output specification

Nominal current	Functions K - R	5 A ~ 1 A ~
	Other functions	8 A ~ 1 A ~
Nominal voltage		250 V ~
Rated power	Functions K - R	1250 VA - 30 W
	Other functions	2000 VA - 30 W
Maximum admissible current		15 A < 0.01 s
Minimum current		50 mA ~
Electrical life at I max 250 V ~ resistive (cycles)	Function K	10 ⁵
	Other functions	1.5 • 10 ⁵
Max. permitted number of operations per hour at I max 250 V ~ resistive		360
Mechanical life (operations)		2 x 10 ⁷

Function and use

Display of output state by LED	output in operation	Green LED
	power on	Red LED
Voltage variation		± 15 % Un 127 V-10% 240 V+10%
Maximum absorbed power		1.5 W / 24 V 5 VA / 110-127 V 10 VA / 220-240 V
Temperature limits	Use	-20 °C + 60 °C
	Stored	-30 °C + 70 °C
Insulation according to the standard VDE 0110 - IEC 255 VDE 0435-2021		250 V ~
Protection class according to UTE C 20010 - IEC 529 - DIN 40050		IP40
Conformity to standards IEC 255 VDE 0435-2021		•
Protection from voltage surge (in joules)		2
Connection: by terminal blocks with cable guide and front-access captive screws		•
Terminal capacity : multi or single wire 1 or 2 leads		2.5 mm ²
Mounting on symmetrical DIN rail 35 mm EN 50022		•
Weight (g)		110

Products currently being replaced by the TR range

Timing

Types

Part numbers (and voltages)

24 V ~ / 110 • 127 V 50 • 60Hz
24 V ~ / 220 • 240 V 50 • 60Hz
24 V ~ / 50 • 60Hz
110 • 127 V 50 • 60Hz
220 • 240 V 50 • 60Hz
24 • 240 V ~ 50 • 60Hz
N.B. : For 48 V ~ supply
Additional resistor : 560 Ω 2W / 24V ~

Functions

Relay output

Nominal current

Timing ranges (8 available options)

0.1 s to 1 s	0.4 min to 4 min	1 h to 10 h
1 s to 10 s	1 min to 10 min	6 h to 60 h
6 s to 60 s	6 min to 60 min	
Fixed pulse		

Function diagrams

Terminal connections

- A1 - A2 : Supply
- A3 : Bridge (A2 - A3) for 24V supply
- 15 - 16 - 18 : Timed output contact
- B1 - B2 : Control contact
- 15 - 16 - 18 : Instantaneous contact 1
- B2 - B3 - A3 : Instantaneous contact 2
- Galvanic insulation Input-Output

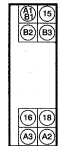

Accessories

Panel adaptor **79 237 806**

Function diagrams

Function D Flip-flop

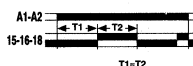

Function E Flip-flop



Function K Delay on de-energisation

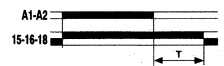

Function O Delayed safe-guard



Function R Instantaneous relay

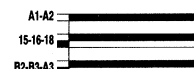

Function S Star-delta

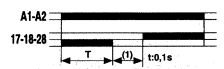

(1) B2 B3
• • 0,1s
— 0,035s

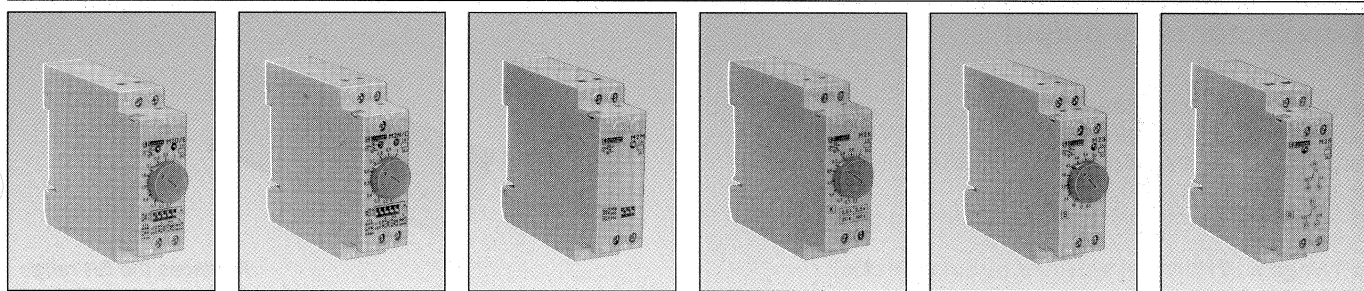

0.1 s • 60 h	0.1 s • 60 h	—	0.06 s • 160 s	3 s • 60 s	—
M2 D/E	M2 N/O	M2 M	M2 K	M2 S	M2 R
88 883 105	88 883 205	88 883 305	—	88 883 505	—
88 883 106	88 883 206	88 883 306	—	88 883 506	—
—	—	—	—	—	88 883 600
—	—	—	—	—	88 883 602
—	—	—	88 883 408	—	88 883 604
—	—	—	—	—	—
•	•	•	—	•	•

1
2

Multi-function with selection	Multi-function with selection	Multi-function with selection	Mono-function	Mono-function	Mono-function
D/E	N/O	Ma/Mb/Mc	K	S	R
1 changeover	1 changeover	1 changeover	1 changeover	1 changeover	2 changeover
8 A ~ 1A ~	8 A ~ 1A ~	8 A ~ 1A ~	8 A ~ 1A ~	8 A ~ 1A ~	8 A ~ 1A ~

•	•	—	0.06 s • 0.6 s 2 s • 20 s	0.25 s • 2.5 s 16 s • 160 s	3 s • 60 s	—
0.5 s ± 0.2						

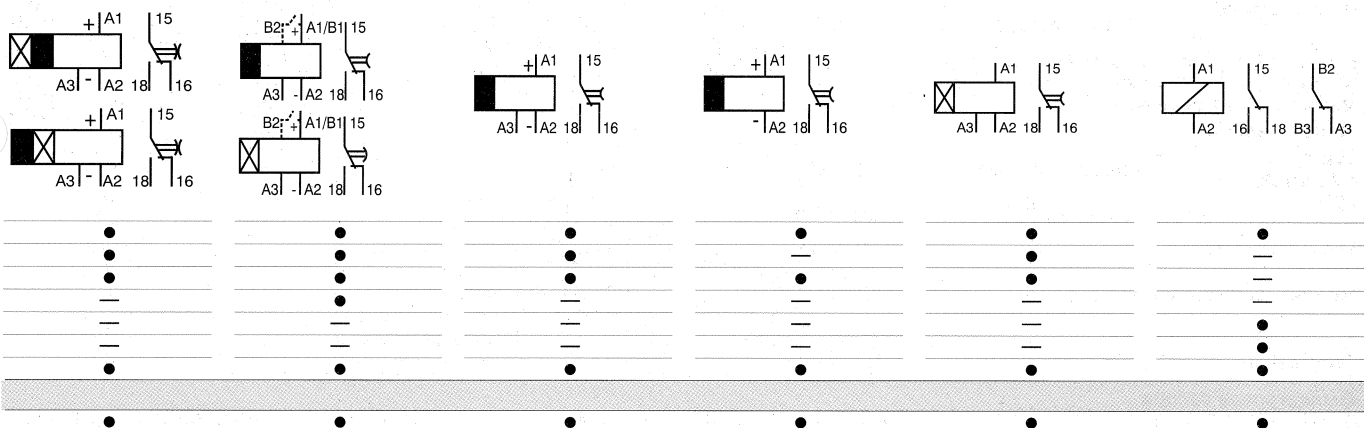

3

Function N
"Safe-guard"

Function M
Pulse output

Ma

Mb

Mc

Connection

Dimensions

Adaptor : 79 237 806
To convert from DIN rail to screw mounting by 2 x 4 mm screws.

Mounting

Removal

3

To order, specify :

Standard products, non stocked	1 Type	2 Part number	3 Accessory
Example : M2 D/E electronic timer - 88 883 105 - Panel adaptor 79 237 806			