

SparkFun Inventor's Kit Experiment Guide - v4.0

Introduction

The SparkFun Inventor's Kit (SIK) is your map for navigating the waters of beginning embedded electronics. This guide contains all the information you will need to build five projects encompassing the 16 circuits of the SIK. At the center of this guide is one core philosophy: that anyone can (and should) play around with electronics. When you're done with this guide, you will have built five projects and acquired the know-how to create countless more. Now enough talk — let's start something!

The print version of this guide is available as a PDF as well. Click the following link to view it.

[SIK V4.0A GUIDE PDF](#)

Notice: This online guide is kept up to date with all the most recent improvements and corrections. For users following along with the printed version of this guide, please visit sparkfun.com/SIKerrata for any and all changes that may affect your experience while using the printed guide.

Choosing a Kit

You should have one of the two following versions of the SIK. If you need an overview of the parts included in your kit, please click on the product link below.





SparkFun Inventor's Kit for Arduino Uno - v4.0

🕒 KIT-14418

The primary difference between the two kits is the microcontroller included in the kit. The SparkFun Inventor's Kit includes a SparkFun RedBoard, while the SparkFun Inventor's Kit for Arduino Uno includes an Arduino Uno R3. At the heart of each is the ATmega328p microcontroller, giving both the same functionality underneath the hood. Both development boards are capable of taking inputs (such as the push of a button or a reading from a light sensor) and interpreting that information to control various outputs (like a blinking LED light or an electric motor). And much, much more!

Note: The Arduino Uno version of the kit **does not** include a carrying case or printed copy of this manual to decrease weight and cost for international shipping.

Note: You can complete all 16 experiments in this guide with either kit.

If you need more information to determine which microcontroller is right for you, please check out the following tutorials.

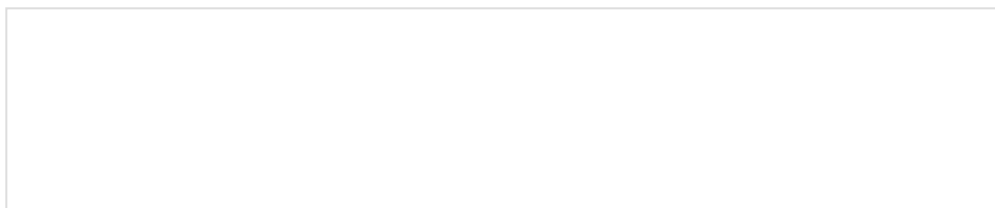

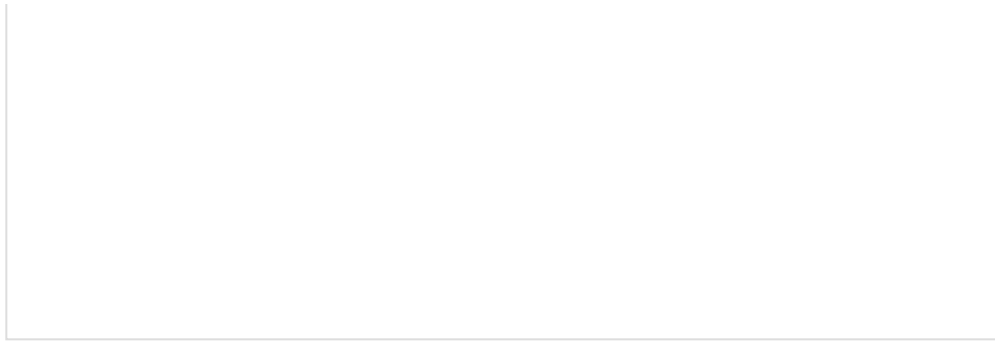

RedBoard Hookup Guide

JANUARY 7, 2014

How to get your RedBoard up-and-blinking!

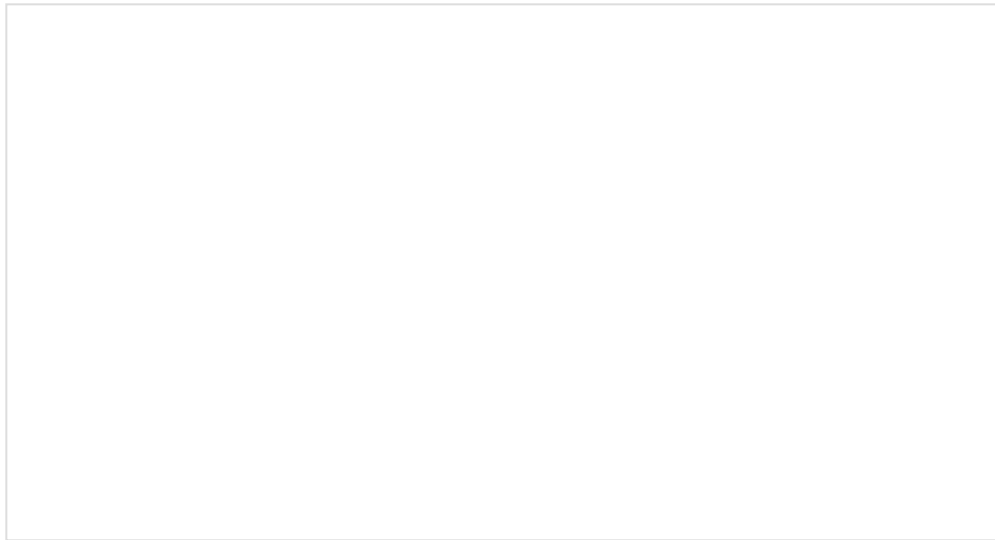

What is an Arduino?

FEBRUARY 26, 2013

What is this 'Arduino' thing anyway?

Open Source!

At SparkFun, our engineers and educators have been improving this kit and coming up with new experiments for a long time now. We would like to give attribution to Oomlout, since we originally started working off their Arduino Kit material many years ago. The Oomlout version is licensed under the Creative Commons Attribution Share-Alike 3.0 Unported License.

The SparkFun Inventor's Kit V4.0 is licensed under the Creative Commons Attribution Share-Alike 4.0 International License.

Baseplate Assembly

Before you can build circuits, you'll want to first assemble the breadboard baseplate. This apparatus makes circuit building easier by keeping the breadboard and the RedBoard microcontroller connected together without the worry of disconnecting or damaging your circuit. The larger the circuit, the more wires needed to build it. The more wires there are, the easier it is for one of those wires to come undone.

To begin, grab all the parts: the RedBoard, the breadboard, the included screwdriver, the baseplate and the two baseplate screws.

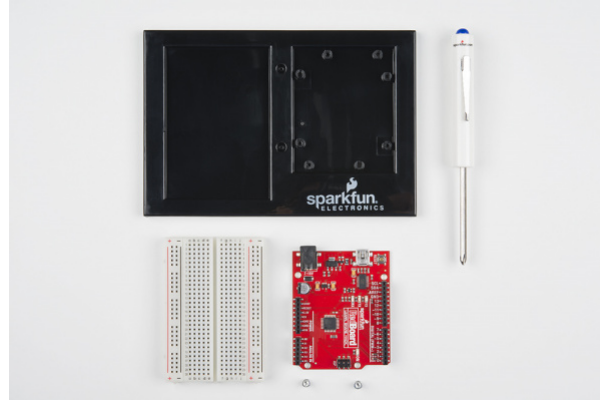

If the screwdriver end is a flathead screwdriver, pull the shaft out, rotate it around to the Phillips head screwdriver side, and reinsert the shaft.

Next, peel the adhesive backing off the breadboard.



Carefully align the breadboard over its spot on the baseplate. The text on the breadboard should face the same direction as the text on the baseplate. Firmly press the breadboard to the baseplate to adhere it.

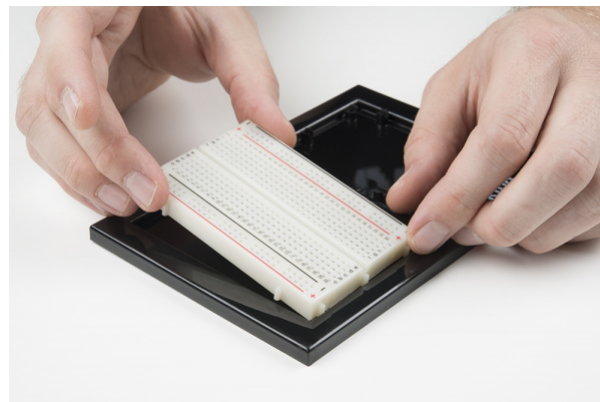

Align the RedBoard with its spot on the baseplate. The text on it should face the same direction as the text on the breadboard and the baseplate. Grab one of the two included screws, and firmly screw it into one of the four stand-off holes found on the RedBoard. The plastic holes are not threaded, so you will need to apply pressure as you twist the screwdriver.

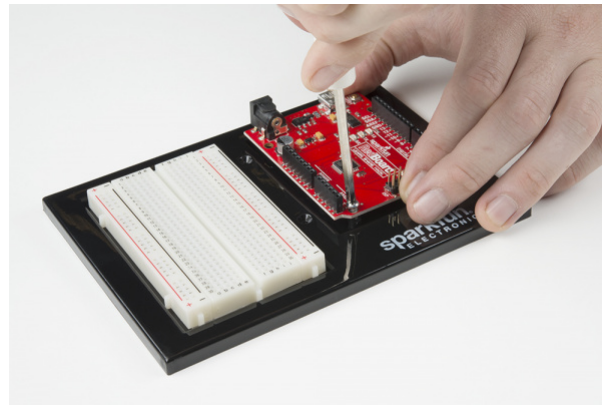

Screw the second screw in the stand-off hole diagonally across from the first. With that, your baseplate is now assembled.

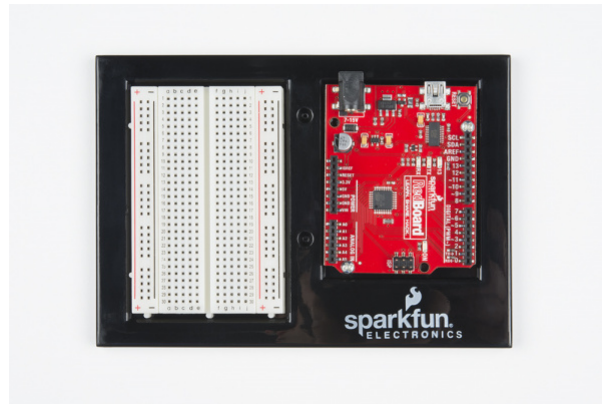

Arduino Uno Baseplate Assembly

Newer versions of the Arduino Uno come with a clear, plastic baseplate of their own. It will need to be removed before the Uno can be attached to the breadboard baseplate. To remove it, pull it from the Uno.

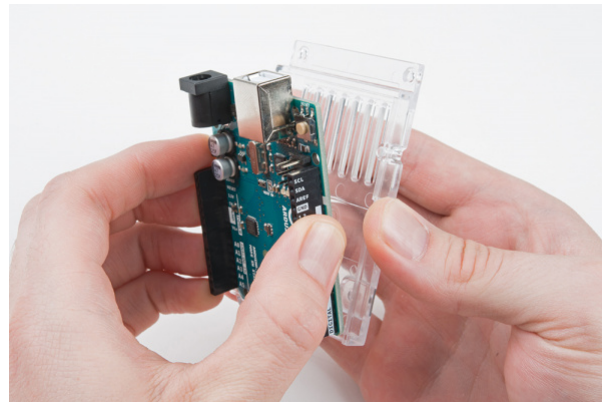

You may now attach the Uno to the baseplate as shown in the instructions above.

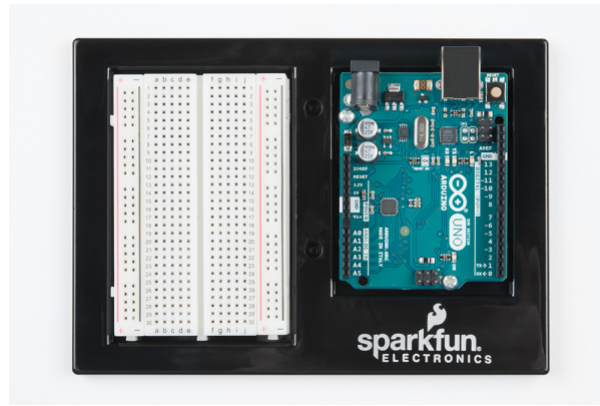

Please Note: The Arduino Uno and the SparkFun RedBoard are pin-for-pin identical. Though the circuits in this guide show the SparkFun RedBoard, the Arduino Uno can be interchanged and used with all the same circuit diagrams and hookup tables. All the pin names and locations are the same on both development platforms.

The SparkFun RedBoard

The SparkFun RedBoard is your development platform. At its roots, the RedBoard is essentially a small, portable computer, also known as a microcontroller. It is capable of taking inputs (such as the push of a button or a reading from a light sensor) and interpreting that information to control various outputs (like blinking an LED light or spinning an electric motor). That's where the term "physical computing" comes in; this board is capable of taking the world of electronics and relating it to the physical world in a real and tangible way.

The SparkFun RedBoard is one of a multitude of development boards based on the ATmega328 microprocessor. It has 14 digital input/output pins (six of which can be PWM outputs), six analog inputs, a 16MHz crystal oscillator, a USB connection, a power jack, and a reset button. You'll learn more about each of the RedBoard's features as you progress through this guide.

Check out the guide below to learn more about the SparkFun RedBoard.

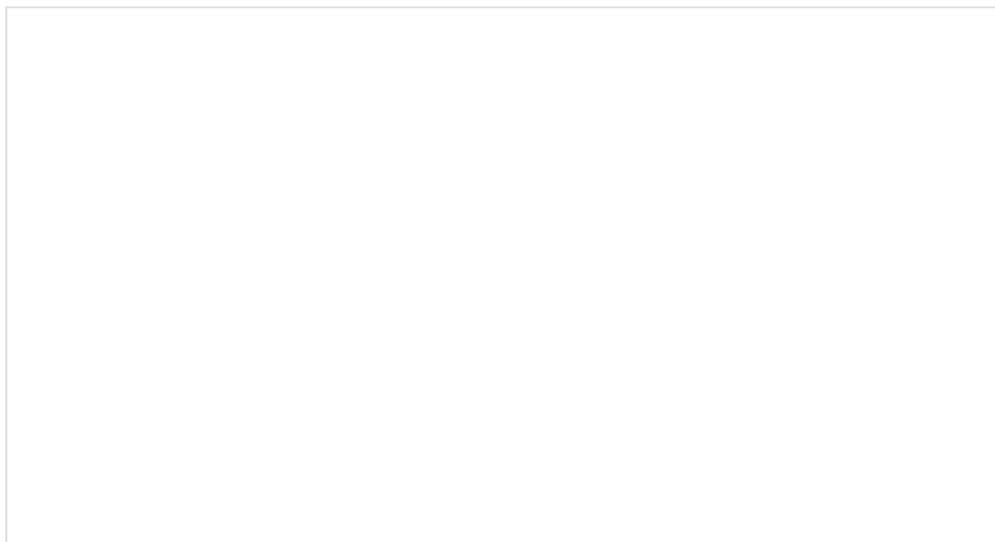

RedBoard Hookup Guide

JANUARY 7, 2014

How to get your RedBoard up-and-blinking!

Understanding Breadboards

A breadboard is a circuit-building platform that allows you to connect multiple components without using a soldering iron.

If you have never seen or used a breadboard before, it is highly recommended you read the following guide that explains the breadboards anatomy and how to use one.

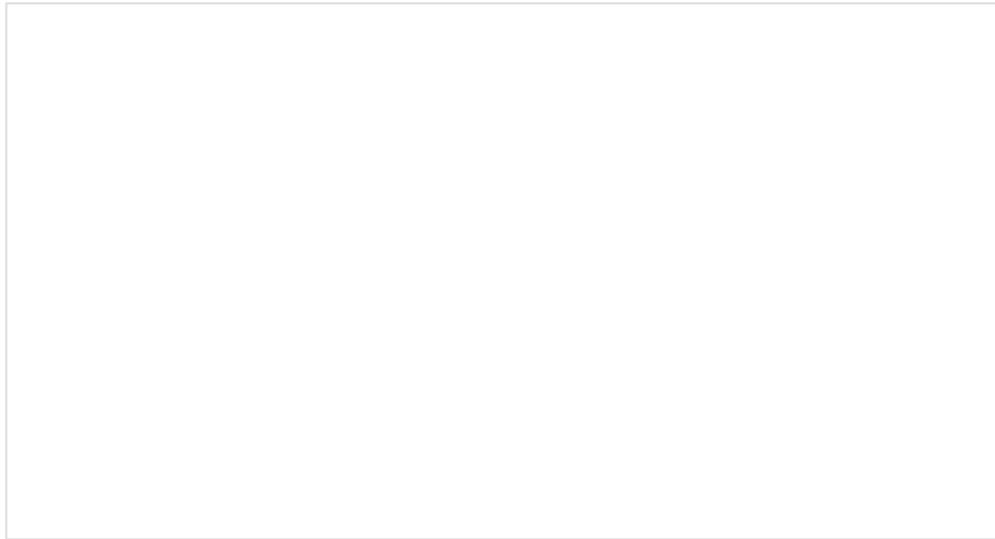

How to Use a Breadboard

MAY 14, 2013

Welcome to the wonderful world of breadboards. Here we will learn what a breadboard is and how to use one to build your very first circuit.

Install the Arduino IDE and SIK Code

The following steps are a basic overview of getting started with the Arduino IDE. For more detailed, step-by-step instructions for setting up the Arduino IDE on your computer, please check out the following tutorial.

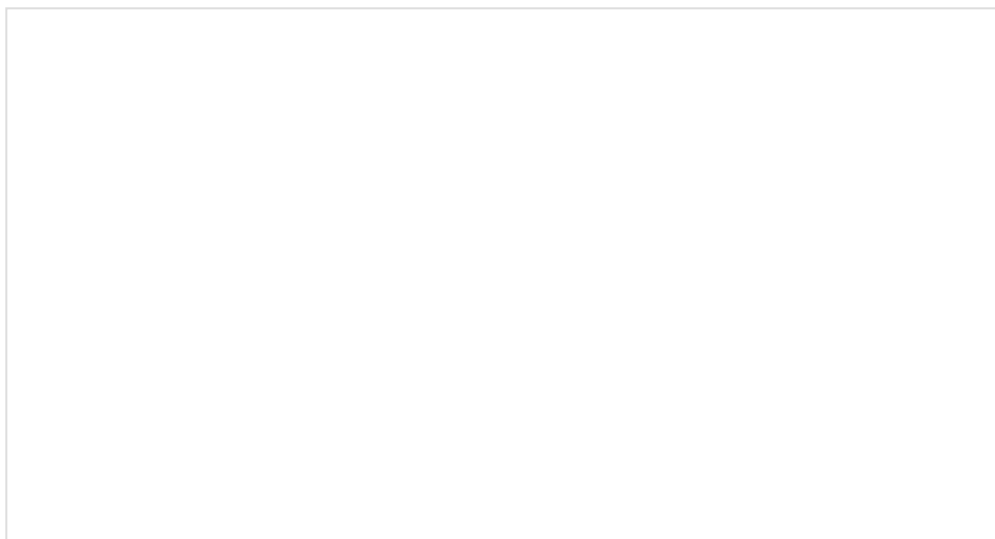

Installing Arduino IDE

MARCH 26, 2013

A step-by-step guide to installing and testing the Arduino software on Windows, Mac, and Linux.

Download the Arduino IDE

In order to get your microcontroller up and running, you'll need to download the newest version of the Arduino software first (it's free and open source!).

[DOWNLOAD THE ARDUINO IDE](#)

This software, known as the Arduino IDE, will allow you to program the board to do exactly what you want. It's like a word processor for writing code.

Download Arduino Code

You are so close to being done with setup! Download the SIK Guide Code. Click the following link to download the code:

[SIK V4.0A CODE](#)

You can also download the code from GitHub.

Place the `SIK-Guide-Code` folder in the Arduino IDE `examples` directory:

- **Windows:** drag the `SIK-Guide-Code-V4.0a` folder into `C:\program files\Arduino-x\examples`
- **MacOS:** Right-click on the Arduino IDE app and click "Show Package Contents...". Drag the `SIK-Guide-Code-V4.0a` folder into `Contents/Resources/Java`
- **Linux:** see <http://www.arduino.cc/playground/Learning/Linux>

Connect the Microcontroller to your Computer

Use the USB cable provided in the SIK kit to connect the included microcontroller (RedBoard or Arduino Uno) to one of your computer's USB inputs.

Install FTDI Drivers

Depending on your computer's operating system, you will need to follow specific instructions. Please go to [How to Install FTDI Drivers](#), for specific instructions on how to install the FTDI drivers onto your RedBoard.

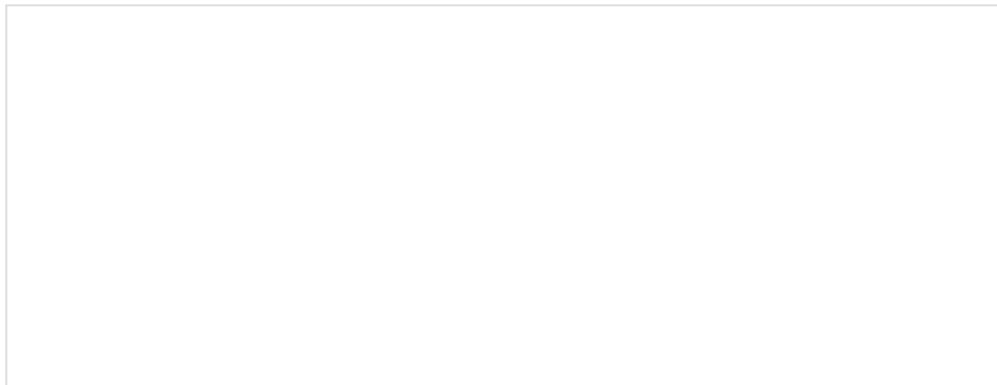

USB Serial Driver Quick Install

AUGUST 31, 2017

How to install USB serial drivers on Windows, MacOS , and Linux.

Select your Board: Arduino/Genuino Uno

Before we can start jumping into the experiments, there are a couple adjustments we need to make. This step is required to tell the Arduino IDE *which* of the many Arduino boards we have. Go up to the **Tools** menu. Then hover over **Board** and make sure **Arduino Uno** is selected.

Please note: Your SparkFun RedBoard and the Arduino UNO are interchangeable but you won't find the RedBoard listed in the Arduino Software. Select "Arduino/Genuino Uno" instead.

Select a Serial Port

Next up we need to tell the Arduino IDE which of our computer's serial ports the microcontroller is connected to. For this, again go up to **Tools**, then hover over **Port (Serial Port** in older Arduino versions) and select your RedBoard or Arduino's serial port. This will be the same serial port seen when installing FTDI drivers.

With that, you're now ready to begin building your first circuit!

Project 1: Light

Welcome to your first SparkFun Inventor's Kit project. Each project is broken up into several circuits, each designed to help you learn about new technologies and concepts. The knowledge gained from each circuit will play a part in building each project. This first project will set the foundation for the rest of the projects in the guide and will aid in helping you understand the basic fundamentals of circuit building and electricity!

In Project 1, you will learn about light-emitting diodes (LEDs), resistors, inputs and sensors — using all of those technologies to build and program your own multicolored night-light! The night-light uses a sensor to turn on an RGB (Red, Green, Blue) LED when it gets dark, and you will be able to change the color using an input knob.

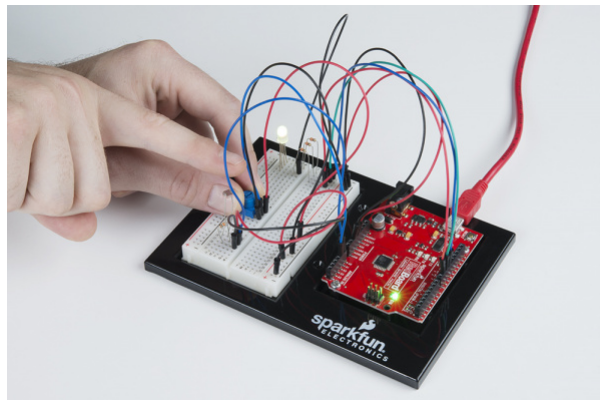

New Components Introduced in This Project

Each of the components listed below will be described in more detail as you progress through each project.

- LEDs
- Resistors
- Potentiometers
- Photoresistors

New Concepts Introduced in This Project

Each of the concepts listed below will be described in more detail as you progress through each project.

- Polarity
- Ohm's Law
- Digital Output
- Analog vs. Digital
- Analog Input
- Analog to Digital Conversion
- Voltage Divider
- Pulse-width Modulation
- Functions

You Will Learn

- How to upload a program to your RedBoard or Arduino Uno
- Circuit building basics
- How to control LEDs with digital outputs
- How to read sensors you analog inputs

Circuit 1A: Blink an LED

Light-Emitting Diodes, or LEDs (pronounced el-ee-dees), are small, powerful lights that are used in many different applications. You can find LEDs in just about any source of light nowadays, from the bulbs lighting your home to the tiny status lights flashing on your home electronics. Blinking an LED is the classic starting point for learning how to program embedded electronics. It's the "Hello, World!" of microcontrollers.

In this circuit, you'll write code that makes an LED flash on and off. This will teach you how to build a circuit, write a short program and upload that program to your RedBoard.

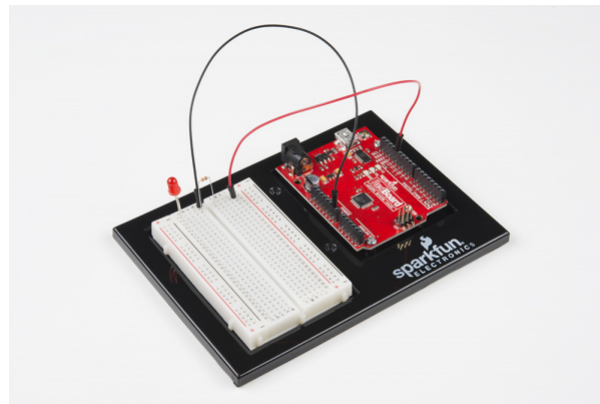

Parts Needed

Grab the following quantities of each part listed to build this circuit:

New Components and Concepts: Each circuit will introduce new components or parts that will be used in the circuit. Each circuit will also introduce a few new concepts that will help you understand what your circuit and code is doing and why.

New Components

LED (Light Emitting Diode)

Light-Emitting Diodes (LEDs) are small lights made from a silicon diode. They come in different colors, brightnesses and sizes. LEDs have a positive (+) leg and a negative (-) leg, and they will only let electricity flow through them in one direction. LEDs can also burn out if too much electricity flows through them, so you should always use a resistor to limit the current when you wire an LED into a circuit.

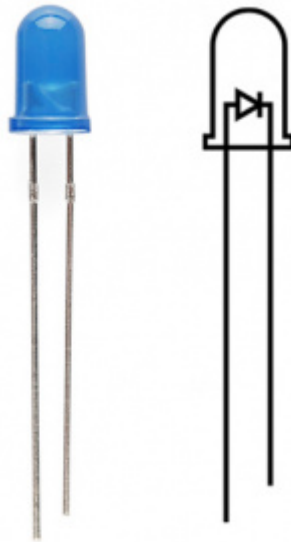

Resistors

Resistors resist the flow of electricity. You can use them to protect sensitive components like LEDs. The strength of a resistor (measured in ohms) is marked on the body of the resistor using small colored bands. Each color stands for a number, which you can look up using a resistor chart.



New Concepts

Polarity

Many electronics components have polarity, meaning electricity can only flow through them in one direction. Components like resistors do not have polarity; electricity can flow through them in either direction. However, components like an LED that do have polarity only work when electricity flows through them in one direction.

Ohm's Law

Ohm's law describes the relationship between the three fundamental elements of electricity: **voltage**, **resistance** and **current**. This relationship can be represented by the following equation:

$$V = I \cdot R$$

Where

- V = Voltage in volts
- I = Current in amps
- R = Resistance in ohms (Ω)

This equation is used to calculate what resistor values are suitable to sufficiently limit the current flowing to the LED so that it does not get too hot and burn out.

Digital Output

When working with microcontrollers such as the RedBoard, there are a variety of pins to which you can connect electronic components. Knowing which pins perform which functions is important when building your circuit. In this circuit, we will be using what is known as a **digital output**. There are 14 of these pins found on the RedBoard and Arduino Uno. A digital output only has **two states: ON or OFF**. These two states can also be thought of as **HIGH or LOW** or **TRUE or FALSE**. When an LED is connected to one of these pins, the pin can only perform two jobs: turning the LED on and turning the LED off. We'll explore the other pins and their functions in later circuits.

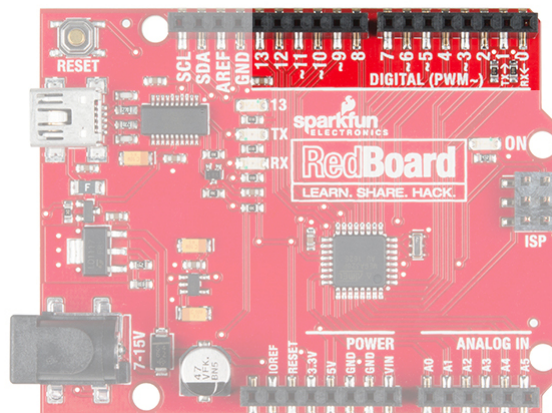

The 14 digital pins highlighted.

Hardware Hookup

We recommend familiarizing yourself with each of the components used in each circuit first.

Polarized Components 	Pay special attention to the component's markings indicating how to place it on the breadboard. Polarized components can only be connected to a circuit in one direction.
---	---

Pay close attention to the LED. It is polarized. The negative side of the LED is the short leg, marked with a flat edge.

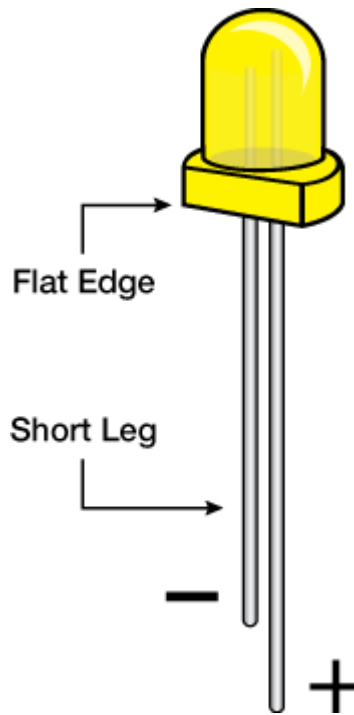

Components like resistors need to have their legs bent into 90° angles in order to correctly fit the breadboard sockets.

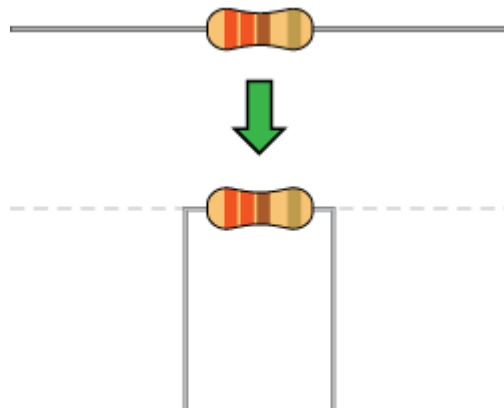

Ready to start hooking everything up? Check out the circuit diagram and hookup table below, to see how everything is connected.

Circuit Diagram

Circuit Diagrams: SparkFun uses a program called Fritzing to draw the circuit diagrams you see throughout this guide and throughout all of our online guides. Fritzing allows us to create diagrams that make it easier for you to see how your circuit should be built.

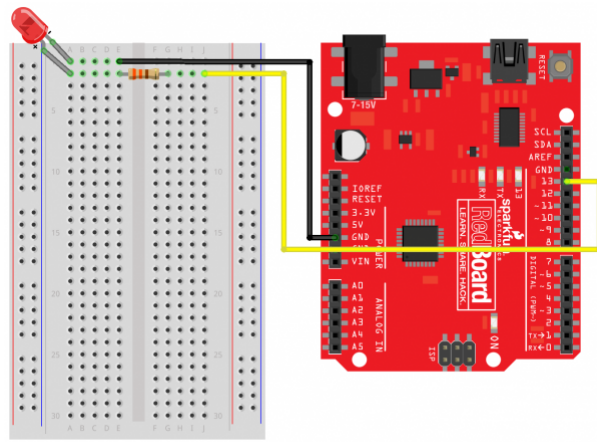

fritzing

Having a hard time seeing the circuit? Click on the image for a closer look.

Hookup Table

Hookup Tables: Many electronics beginners find it helps to have a coordinate system when building their circuits. For each circuit, you'll find a hookup table that lists the coordinates of each component and where it connects to the RedBoard, the breadboard, or both. The breadboard has a letter/number coordinate system, just like the game Battleship.

Component	RedBoard	Breadboard	Breadboard
LED ⚠		A1 LED (-)	A2 LED (+)
330Ω Resistor (orange, orange, brown)		E2	F2
Jumper Wire	GND	E1	
Jumper Wire	Digital Pin 13	J2	

*In the table, polarized components are shown with a warning triangle and the **whole row highlighted yellow**.*

Open Your First Sketch

Open the Arduino IDE software on your computer. Open the code for Circuit 1A by accessing the SIK Guide Code you downloaded and placed into your `examples` folder earlier.

To open the code, go to: **File > Examples > SIK_Guide_Code-V_4 > SIK_Circuit_1A-Blink**

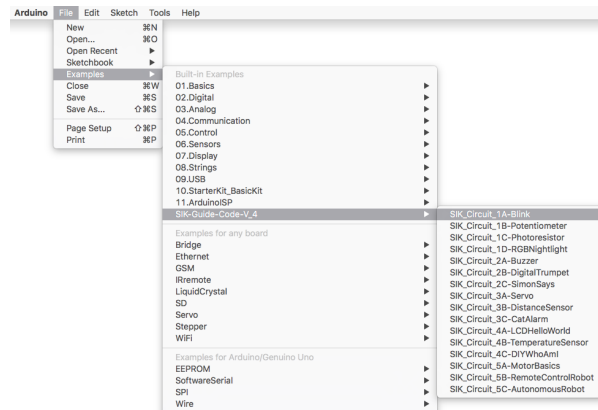

You can also copy and paste the following code into the Arduino IDE. Hit upload, and see what happens!

```
/*
SparkFun Inventor's Kit
Circuit 1A-Blink

Turns an LED connected to pin 13 on and off. Repeats forever.

This sketch was written by SparkFun Electronics, with lots of help from the Arduino community.
This code is completely free for any use.

View circuit diagram and instructions at: https://learn.sparkfun.com/tutorials/sparkfun-inventor-s-kit-experiment-guide---v40
Download code at: https://github.com/sparkfun/SIK-Guide-Code
*/

void setup() {

  pinMode(13, OUTPUT);    // Set pin 13 to output
}

void loop() {

  digitalWrite(13, HIGH); // Turn on the LED

  delay(2000);            // Wait for two seconds

  digitalWrite(13, LOW);  // Turn off the LED

  delay(2000);            // Wait for two seconds
}
```

What You Should See

The LED will flash on for two seconds, off for two seconds, then repeat. If it doesn't, make sure you have assembled the circuit correctly and verified and uploaded the code to your board, or see the Troubleshooting section at the end of this section.

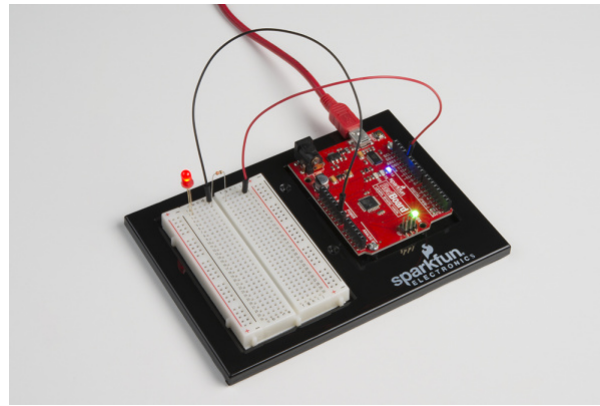

Program Overview

1. Turn the LED on by sending power to Pin 13.
2. Wait 2 seconds (2000 milliseconds).
3. Turn the LED off by cutting power to Pin 13.
4. Wait 2 seconds (2000 milliseconds).
5. Repeat.

One of the best ways to understand the code you just uploaded is to change something and see how it affects the behavior of your circuit. For this first circuit, try changing the number found in these lines of code: `delay(2000);` . What happens if you change both to `100` ? What happens if you change both to `5000` ? What happens if you change just one delay and not the other?

Onboard LED PIN 13: You may have noticed a second, smaller LED blinking in unison with the LED in your breadboard circuit. This is known as the onboard LED, and you can find one on almost any Arduino or Arduino-compatible board including the RedBoard. In most cases, this LED is connected to **digital pin 13 (D13)**, which is the same pin used in this circuit. This LED is useful for troubleshooting, as you can always upload the Blink sketch to see if that LED lights up. If so, you know your board is functioning properly. If you do not want this LED to blink with other LEDs in your circuits, simply use any of the other 12 digital pins (D0-D12).

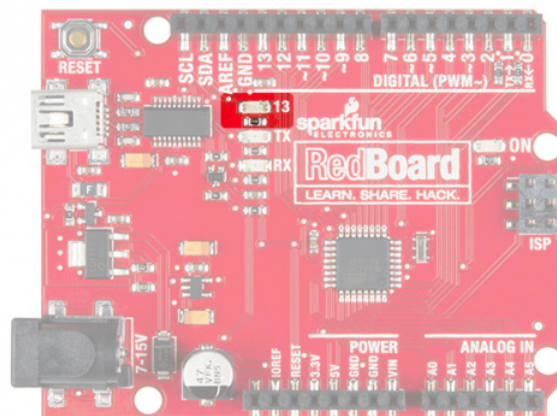

Code to Note

Code to Note: The sketches that accompany each circuit introduce new programming techniques and concepts as you progress through the guide. The Code to Note section highlights specific lines of code from the sketch and explains them in further detail.

Code	Description
Setup and Loop: <pre>void setup(){code to run once} & void loop(){code to run forever}</pre>	Every Arduino program needs these two functions. Code that goes in between the curly brackets of <code>setup()</code> runs once, then the code in between the <code>loop()</code> curly brackets runs over and over until the RedBoard is reset or powered off.
Input or Output?: <pre>pinMode(13, OUTPUT);</pre>	Before you can use one of the digital pins, you need to tell the RedBoard whether it is an INPUT or OUTPUT. We use a built-in "function" called <code>pinMode()</code> to make pin 13 a digital output . You'll learn more about digital inputs in Project 2.
Digital Output: <pre>digitalWrite(13, HIGH);</pre>	When you're using a pin as an OUTPUT, you can command it to be HIGH (output 5 volts) or LOW (output 0 volts).
Delay: <pre>delay(time in milliseconds);</pre>	Causes the program to wait on this line of code for the amount of time in between the brackets. After the time has passed, the program will continue to the next line of code.
Comments: <pre>//This is a comment</pre>	Comments are a great way to leave notes in your code explaining why you wrote it the way you did. You'll find many comments in the examples that further explain what the code is doing and why. Comments can be single line using <code>//</code> , or they can be multi-line using <code>/* */</code> .

Coding Challenges

Coding Challenges: The Coding Challenges section is where you can find suggestions for changes to the circuit or code that will make the circuit more challenging. If you feel underwhelmed by the tasks in each circuit, visit the Coding Challenges section to push yourself to the next level.

Challenge	Description
Persistence of Vision	Computer screens, movies and the lights in your house all flicker so quickly that they appear to be on all of the time but are actually blinking faster than the human eye can detect. See how much you can decrease the delay time in your program before the light appears to be on all the time but is still blinking.
Morse Code	Try changing the delays and adding more <code>digitalWrite()</code> commands to make your program blink a message in Morse code.

Troubleshooting

Troubleshooting: Last, each circuit has a Troubleshooting section with helpful tips and tricks to aid you in any problems you encounter along the way.

Problem	Solution
I get an error when uploading my code	The most likely cause is that you have the wrong board selected in the Arduino IDE. Make sure you have selected Tools > Board > Arduino/Genuino Uno .
I still get an error when uploading my code	If you're sure you have the correct Board selected but you still can't upload, check that you have selected the correct Serial Port. You can change this in Tools > Serial Port > <i>your_serial_port</i> .
Which Serial Port is the right one?	Depending on how many devices you have plugged into your computer, you may have several active Serial Ports. Make sure you are selecting the correct one. A simple way to determine this is to look at your list of Serial Ports. Unplug your RedBoard from your computer. Look at the list again. Whichever Serial Port has disappeared from the list is the one you want to select once you plug your board back in to your computer.
My code uploads, but my LED won't turn on	LEDs will only work in one direction. Try taking it out of your breadboard, turning it 180 degrees, and reinserting it.
Still not working?	Jumper wires unfortunately can go "bad" from getting bent too much. The copper wire inside can break, leaving an open connection in your circuit. If you are certain that your circuit is wired correctly and that your code is error-free and uploaded but you are still encountering issues, try replacing one or more of the jumper wires for the component that is not working.

Circuit 1B: Potentiometer

Potentiometers (also known as “pots” or “knobs”) are one of the basic inputs for electronics devices. By tracking the position of the knob with your RedBoard, you can make volume controls, speed controls, angle sensors and a ton of other useful inputs for your projects. In this circuit, you'll use a potentiometer as an input device to control the speed at which your LED blinks.

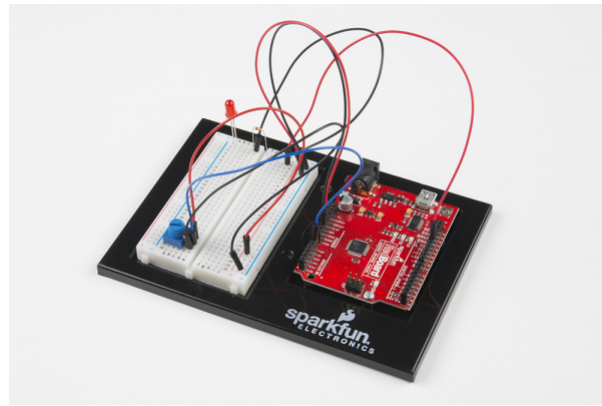

Parts Needed

Grab the following quantities of each part listed to build this circuit:

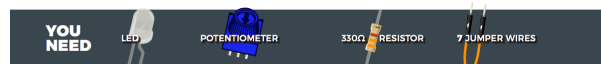

New Components

Potentiometer

A potentiometer (trimpot for short) is a variable resistor. When powered with 5V, the middle pin outputs a voltage between 0V and 5V, depending on the position of the knob on the potentiometer. Internal to the trimpot is a single resistor and a wiper, which cuts the resistor in two and moves to adjust the ratio between both halves. Externally, there are usually three pins: two pins connect to each end of the resistor, while the third connects to the pot's wiper.

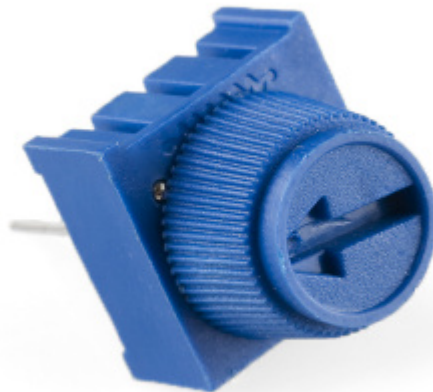

New Concepts

Analog vs. Digital

Understanding the difference between analog and digital is a fundamental concept in electronics.

We live in an analog world. There is an infinite number of colors to paint an object (even if the difference is indiscernible to our eye), an infinite number of tones we can hear, and an infinite number of smells we can smell. The common theme among all of these **analog** signals is their **infinite** possibilities.

Digital signals deal in the realm of the **discrete** or **finite**, meaning there is a limited set of values they can be. The LED from the previous circuit had only two states it could exist in, ON or OFF, when connected to a Digital Output.

Analog Inputs

So far, we've only dealt with outputs. The RedBoard also has inputs. Both inputs and outputs can be analog or digital. Based on our definition of analog and digital above, that means an analog input can sense a wide range of values versus a digital input, which can only sense two states.

You may have noticed some pins labeled **Digital** and some labeled **Analog In** on your RedBoard. There are only six pins that function as analog inputs; they are labeled A0–A5.

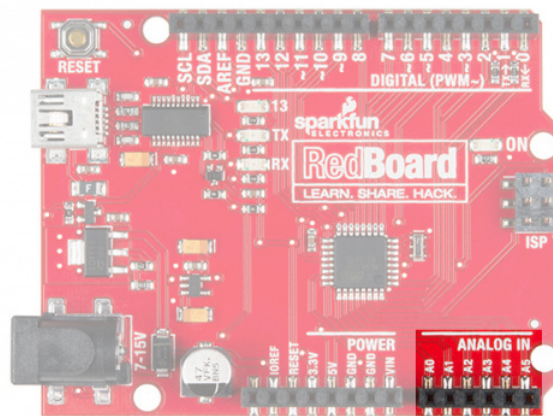

The six analog pins highlighted.

Voltage Divider

A voltage divider is a simple circuit that turns some voltage into a smaller voltage using two resistors. The following is a schematic of the voltage divider circuit. Schematics are a universally agreed upon set of symbols that engineers use to represent electric circuits.

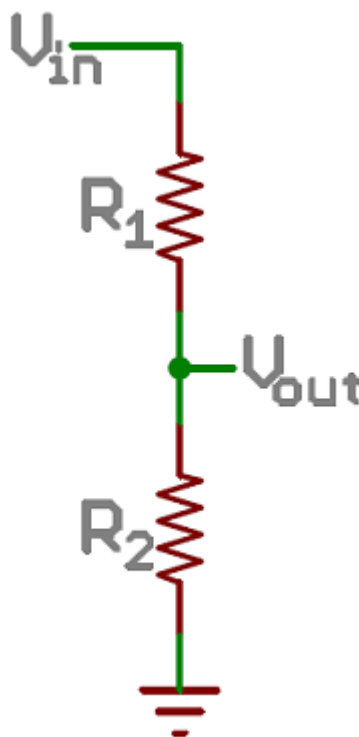

A potentiometer is a variable resistor that can be used to create an adjustable voltage divider.

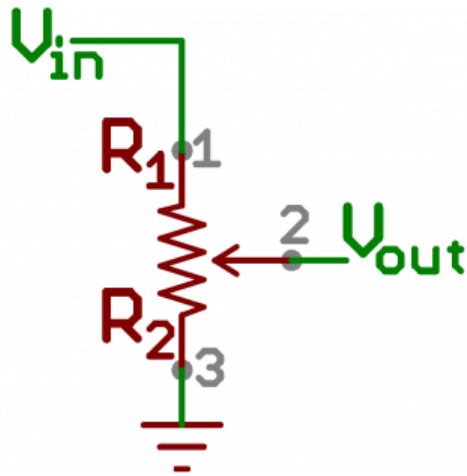

A potentiometer schematic symbol where pins 1 and 3 are the resistor ends, and pin 2 connects to the wiper

If the outside pins connect to a voltage source (one to ground, the other to V_{in}), the output (V_{out}) at the middle pin will mimic a voltage divider. Turn the trimpot all the way in one direction, and the voltage may be zero; turned to the other side, the output voltage approaches the input. A wiper in the middle position means the output voltage will be half of the input.

Voltage dividers will be covered in more detail in the next circuit.

Hardware Hookup

The potentiometer has three legs. Pay close attention into which pins you're inserting it on the breadboard, as they will be hard to see once inserted.

Potentiometers are not polarized. You can attach either of the outside pins to 5V and the opposite to GND. However, the values you get out of the trimpot will change based on which pin is 5V and which is GND.

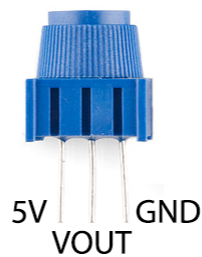

Ready to start hooking everything up? Check out the circuit diagram and hookup table below to see how everything is connected.

Circuit Diagram

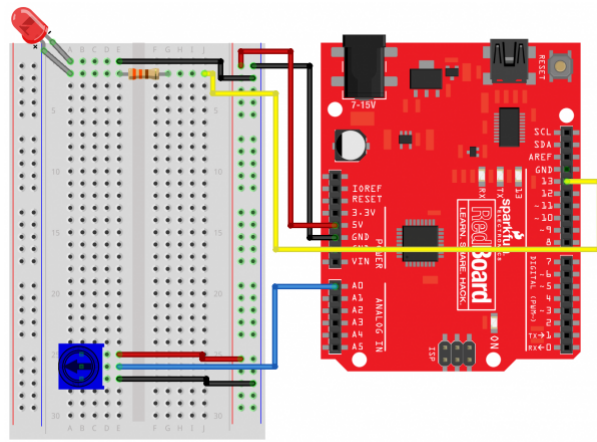

fritzing

Having a hard time seeing the circuit? Click on the image for a closer look.

Hookup Table

Component	RedBoard	Breadboard	Breadboard	Breadboard
Jumper Wire	5V	5V Rail (+)		
Jumper Wire	GND	GND Rail (-)		
LED 		A1 LED (-)	A2 LED (+)	
330Ω Resistor (orange, orange, brown)		E2	F2	
Jumper Wire		E1	GND Rail (-)	
Jumper Wire	Digital Pin 13	J2		
Potentiometer		B25	B26	B27
Jumper Wire	Analog Pin 0 (A0)	E26		
Jumper Wire		E25	5V Rail (+)	
Jumper Wire		E27	GND Rail (-)	

In the table, polarized components are shown with a warning triangle and the **whole row highlighted yellow**.

Open the Sketch

To open the code, go to: **File > Examples > SIK_Guide_Code-V_4 > SIK_Circuit_1B-Potentiometer**

You can also copy and paste the following code into the Arduino IDE. Hit upload, and see what happens!

```

/*
SparkFun Inventor's Kit
Circuit 1B-Potentiometer

Changes how fast an LED connected to pin 13 blinks, based on a potentiometer connected to pin A0

This sketch was written by SparkFun Electronics, with lots of help from the Arduino community.
This code is completely free for any use.

View circuit diagram and instructions at: https://learn.sparkfun.com/tutorials/sparkfun-inventor-s-kit-experiment-guide---v40
Download code at: https://github.com/sparkfun/SIK-Guide-Code
*/

int potPosition;      //this variable will hold a value based on the position of the potentiometer

void setup()
{
  Serial.begin(9600);    //start a serial connection with the computer

  pinMode(13, OUTPUT);  //set pin 13 as an output that can be set to HIGH or LOW
}

void loop()
{
  //read the position of the pot
  potPosition = analogRead(A0);    //set potPosition to a number between 0 and 1023 based on how far the knob is turned
  Serial.println(potPosition);     //print the value of potPosition in the serial monitor on the computer

  //change the LED blink speed based on the trimpot value
  digitalWrite(13, HIGH);          // Turn on the LED
  delay(potPosition);              // delay for as many miliseconds as potPosition (0-1023)

  digitalWrite(13, LOW);           // Turn off the LED
  delay(potPosition);              // delay for as many miliseconds as potPosition (0-1023)
}

```

What You Should See

You should see the LED blink faster or slower in accordance with your potentiometer. The delay between each flash will change based on the position of the knob. If it isn't working, make sure you have assembled the circuit correctly and verified and uploaded the code to your board, or see the Troubleshooting section.

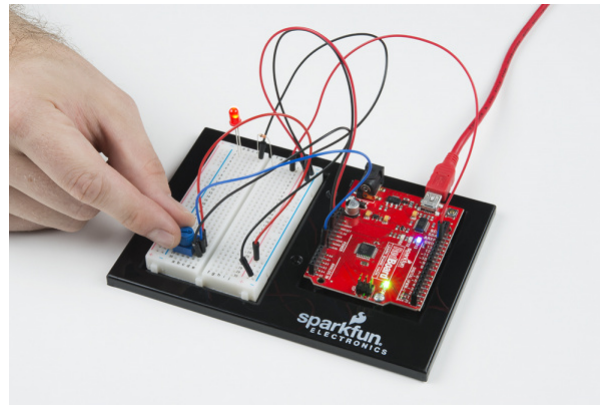

Program Overview

1. Read the position of the potentiometer (from 0 to 1023) and store it in the variable `potPosition` .
2. Turn the LED on.
3. Wait from 0 to 1023 milliseconds, based on the position of the knob and the value of `potPosition` .
4. Turn the LED off.
5. Wait from 0 to 1023 milliseconds, based on the position of the knob and the value of `potPosition` .
6. Repeat.

The Serial Monitor: The Serial Monitor is one of the Arduino IDE's many great built-in tools. It can help you understand the values that your program is trying to work with, and it can be a powerful debugging tool when you run into issues where your code is not behaving the way you expected it to. This circuit introduces you to the Serial Monitor by showing you how to print the values from your potentiometer to it. To see these values, click the Serial Monitor button, found in the upper-right corner of the IDE in most recent versions. You can also select `Tools > Serial Monitor` from the menu.

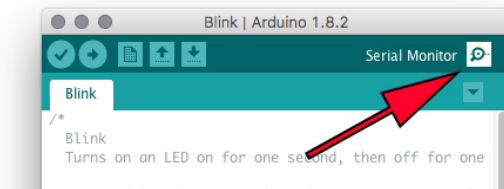

You should then see numeric values print out on the monitor. Turn the potentiometer, and you should see the values change as well as the delay between each print.

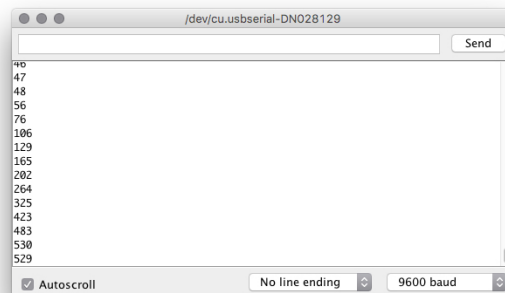

If you are having trouble seeing the values, ensure that you have selected **9600 baud** in the dropdown menu and have auto scroll checked.

Code to Note

Code	Description
Integer Variables: <pre>int potPosition;</pre>	A variable is a placeholder for values that may change in your code. You must introduce, or "declare" variables before you use them. Here we're declaring a variable called <code>potPosition</code> of type <code>int</code> (integer). We will cover more types of variables in later circuits. Don't forget that variable names are case-sensitive!
Serial Begin: <pre>Serial.begin(9600);</pre>	Serial commands can be used to send and receive data from your computer. This line of code tells the RedBoard that we want to "begin" that communication with the computer, the same way we would say "Hi" to initiate a conversation. Notice that the baud rate, 9600, is the same as the one we selected in the monitor. This is the speed at which the two devices communicate, and it must match on both sides.
Analog Input: <pre>potPosition = analogRead(A0);</pre>	We use the <code>analogRead()</code> function to read the value on an analog pin. <code>analogRead()</code> takes one parameter, the analog pin you want to use, <code>A0</code> in this case, and returns a number between 0 (0 volts) and 1023 (5 volts), which is then assigned to the variable <code>potPosition</code> .
Serial Print: <pre>Serial.println(potPosition);</pre>	This is the line that actually prints the trimpot value to the monitor. It takes the variable <code>potPosition</code> and prints whatever value it equals at that moment in the <code>loop()</code> . The <code>ln</code> at the end of <code>print</code> tells the monitor to print a new line at the end of each value; otherwise the values would all run together on one line. Try removing the <code>ln</code> to see what happens.

Coding Challenges

Challenge	Description
Changing the Range	Try multiplying, dividing or adding to your sensor reading so that you can change the range of the delay in your code. For example, can you multiply the sensor reading so that the delay goes from 0–2046 instead of 0–1023?
Adding More LEDs	Add more LEDs to your circuit. Don't forget the current limiting resistor for each one. Try making multiple LEDs blink at different rates by changing the range of each using multiplication or division.

Troubleshooting

Problem	Solution
The potentiometer always reads as 0 or 1023	Make sure that your 5V, A0 and GND pins are properly connected to the three pins on your potentiometer. It is easy to misalign a wire with the actual trimpot pin.

No values in
Serial Monitor

Make sure that you have selected the correct baud rate, **9600**. Also ensure that you are on the correct Serial Port. The same Serial Port you use when uploading code to your board is the same Serial Port you use to print values to the Serial Monitor.

Circuit 1C: Photoresistor

In circuit 1B, you got to use a potentiometer, which varies resistance based on the twisting of a knob. In this circuit you'll be using a photoresistor, which changes resistance based on how much light the sensor receives. Using this sensor you can make a simple night-light that turns on when the room gets dark and turns off when it is bright.

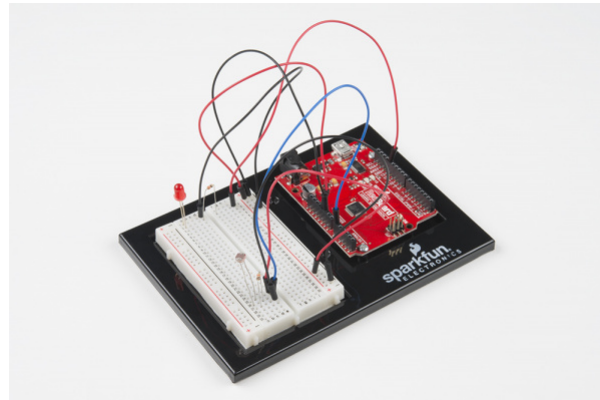

Parts Needed

Grab the following quantities of each part listed to build this circuit:



New Components

Photoresistor

Photoresistors, or photocells, are light-sensitive, variable resistors. As more light shines on the sensor's head, the resistance between its two terminals decreases. They're an easy-to-use component in projects that require ambient-light sensing.



New Concepts

Analog to Digital Conversion

The world we live in is analog, but the RedBoard lives in a digital world. In order to have the RedBoard sense analog signals, we must first pass them through an Analog to Digital Converter (or ADC). The six analog inputs (A0–A5) covered in the last circuit all use an ADC. These pins “sample” the analog signal and create a digital signal for the microcontroller to interpret. The “resolution” of this signal is based on the resolution of the ADC. In the case of the RedBoard, that resolution is 10-bit. With a 10-bit ADC, we get $2^{10} = 1024$ possible values, which is why the analog signal varies between 0 and 1023.

Voltage Divider Continued

Since the RedBoard can't directly interpret resistance (rather, it reads voltage), we need to use a voltage divider to use our photoresistor, a part that doesn't output voltage. The resistance of the photoresistor changes as it gets darker or lighter. That changes the amount of voltage that is read on the analog pin, which "divides" the voltage, 5V in this case. That divided voltage is then read on the analog to digital converter.

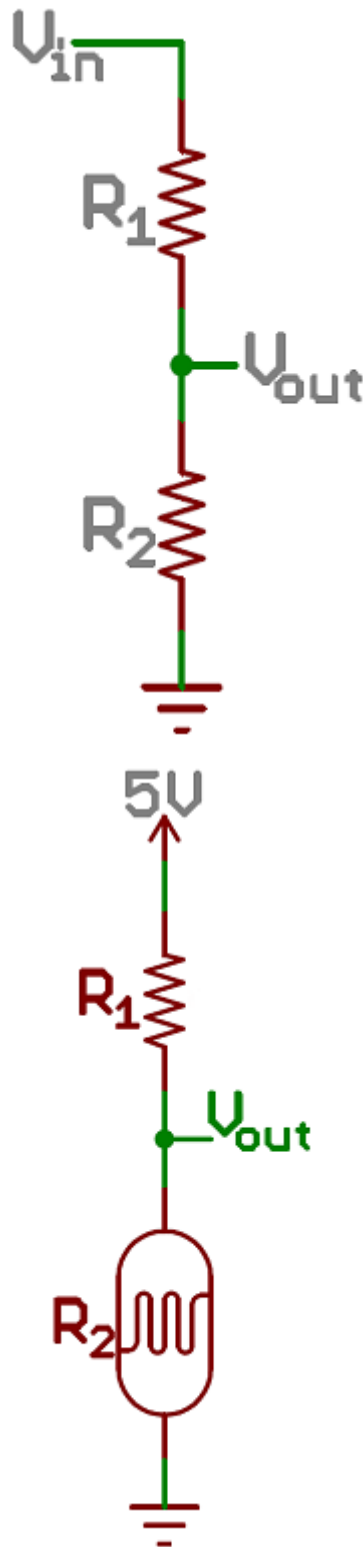

Left: A regular voltage divider circuit. V_{out} will be a constant voltage. Right: A variable voltage divider circuit. V_{out} will fluctuate as the resistance of the photoresistor changes.

The voltage divider equation assumes that you know three values of the above circuit: the input voltage (V_{in}), and both resistor values (R_1 and R_2). Given those values, we can use this equation to find the output voltage (V_{out}):

$$V_{out} = V_{in} \cdot \frac{R_2}{R_1 + R_2}$$

If R_1 is a constant value (the resistor) and R_2 fluctuates (the photoresistor), the amount of voltage measured on the V_{out} pin will also fluctuate.

Hardware Hookup

Note that the photoresistor is not polarized. It can be inserted in either direction.

Ready to start hooking everything up? Check out the circuit diagram and hookup table below to see how everything is connected.

Circuit Diagram

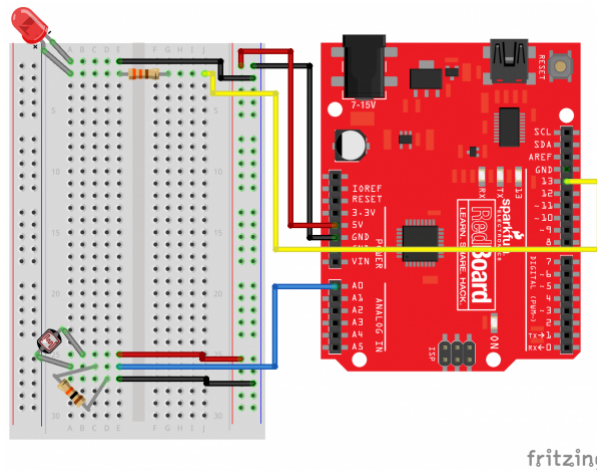

fritzing

Having a hard time seeing the circuit? Click on the image for a closer look.

Hookup Table

Component	RedBoard	Breadboard	Breadboard
Jumper Wire	5V	5V Rail (+)	
Jumper Wire	GND	GND Rail (-)	
LED		A1 LED (-)	A2 LED (+)
330Ω Resistor (orange, orange, brown)		E2	F2
Jumper Wire		E1	GND Rail (-)
Jumper Wire	Digital Pin 13	J2	
Photoresistor		A26	B25
10kΩ Resistor (brown, black, orange)		C26	D27

Jumper Wire	Analog Pin 0 (A0)	E26	
Jumper Wire		E25	5V Rail (+)
Jumper Wire		E27	GND Rail (-)

*In the table, polarized components are shown with a warning triangle and the **whole row** highlighted **yellow**.*

Open the Sketch

To open the code, go to: **File > Examples > SIK_Guide_Code-V_4 > SIK_Circuit_1C-Photoresistor**

You can also copy and paste the following code into the Arduino IDE. Hit upload, and see what happens!

```

/*
SparkFun Inventor's Kit
Circuit 1C-Photoresistor

Use a photoresistor to monitor how bright a room is, and turn an LED on when it gets dark.

This sketch was written by SparkFun Electronics, with lots of help from the Arduino community.
This code is completely free for any use.

View circuit diagram and instructions at: https://learn.sparkfun.com/tutorials/sparkfun-inventor-s-kit-experiment-guide---v40
Download drawings and code at: https://github.com/sparkfun/SIK-Guide-Code
*/

int photoresistor = 0;           //this variable will hold a value based on the position of t
he knob
int threshold = 750;           //if the photoresistor reading is below this value the light
will turn on

void setup()
{
  Serial.begin(9600);           //start a serial connection with the computer

  pinMode(13, OUTPUT);         //set pin 13 as an output that can be set to HIGH or LOW
}

void loop()
{
  //read the position of the knob
  photoresistor = analogRead(A0); //set photoresistor to a number between 0 and 1023 based on
how far the knob is turned
  Serial.println(photoresistor); //print the value of photoresistor in the serial monitor on
the computer

  //if the photoresistor value is below the threshold turn the light on, otherwise turn it off
  if (photoresistor < threshold){
    digitalWrite(13, HIGH);     // Turn on the LED
  } else{
    digitalWrite(13, LOW);     // Turn off the LED
  }

  delay(100);                   //short delay to make the printout easier to read
}

```

What You Should See

The program stores the light level in a variable, `photoresistor`. Then, using an `if/else` statement, the program checks to see what it should do with the LED. If the variable is above the threshold (it's bright), turn the LED off. If the variable is below the threshold (it's dark), turn the LED on. You now have just built your own night-light!

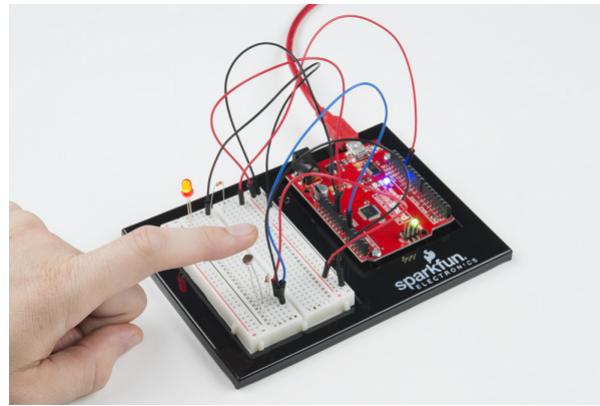

Open the Serial Monitor in Arduino. The value of the photoresistor should be printed every so often. When the photoresistor value drops below the threshold value set in the code, the LED should turn on (you can cover the photoresistor with your finger to make the value drop).

Note: If the room you are in is very bright or dark, you may have to change the value of the “threshold” variable in the code to make your night-light turn on and off. See the Troubleshooting section for instructions.

Program Overview

1. Store the light level in the variable `photoresistor` .
2. If the value of `photoresistor` is above the `threshold` (it's bright), turn the LED off.
3. If the value of `photoresistor` is below the `threshold` (it's dark), turn the LED on.

Code to Note

Code	Description
<p>If/else Statements:</p> <pre>if(logic statement) { code to be run if the logic statement is true} else { code to be run if the logic statement is false }</pre>	<p>The if/else statement lets your code react to the world by running one set of code when the logic statement in the round brackets is true and another set of code when the logic statement is false. For example, this sketch uses an if statement to turn the LED on when it is dark, and turn the LED off when it is light.</p>
<p>Logical Operators:</p> <pre>(photoresistor < threshold)</pre>	<p>Programmers use logic statements to translate things that happen in the real world into code. Logic statements use logical operators such as 'equal to' (<code>==</code>), 'greater than' (<code>></code>), and 'less than' (<code><</code>), to make comparisons. When the comparison is true (e.g., <code>4 < 5</code>) then the logic statement is true. When the comparison is false (e.g., <code>5 < 4</code>) then the logic statement is false. This example is asking whether the variable <code>photoresistor</code> is less than the variable <code>threshold</code>.</p>

Coding Challenges

Challenge	Description
Response Pattern	Right now your if statement turns the LED on when it gets dark, but you can also use the light sensor like a no-touch button. Try using <code>digitalWrite()</code> and <code>delay()</code> to make the LED blink a pattern when the light level drops, then calibrate the threshold variable in the code so that the blink pattern triggers when you wave your hand over the sensor.
Replace 10KΩ Resistor with LED	Alter the circuit by replacing the 10KΩ resistor with an LED (the negative leg should connect to GND). Now what happens when you place your finger over the photoresistor? This is a great way to see Ohm's law in action by visualizing the change in resistance's affect on the current flowing through the LED.

Troubleshooting

Problem	Solution
The light never turns on or always stays on	Start the Serial Monitor in Arduino. Look at the value that the photoresistor is reading in a bright room (e.g., 915). Cover the photoresistor, or turn the lights off. Then look at the new value that the photoresistor is reading (e.g., 550). Set the threshold in between these two numbers (e.g., 700) so that the reading is above the threshold when the lights are on and below the threshold when the lights are off.
Nothing is printing in the Serial Monitor	Try unplugging your USB cable and plugging it back in. In the Arduino IDE, go to Tools > Port, and make sure that you select the right port.

Circuit 1D: RGB Night-Light

In this circuit, you'll take the night-light concept to the next level by adding an RGB LED, which is three differently colored Light-Emitting Diodes (LEDs) built into one component. RGB stands for Red, Green and Blue, and these three colors can be combined to create any color of the rainbow!

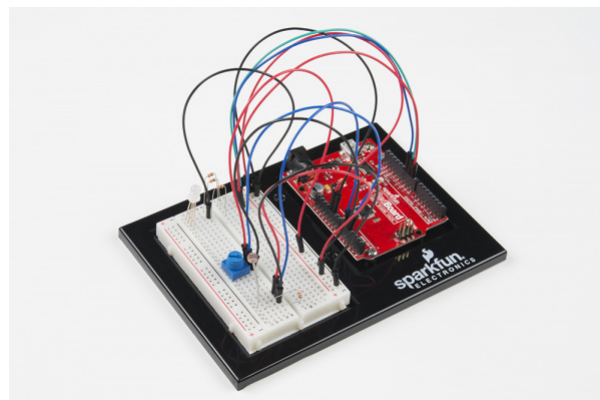

Parts Needed

Grab the following quantities of each part listed to build this circuit:

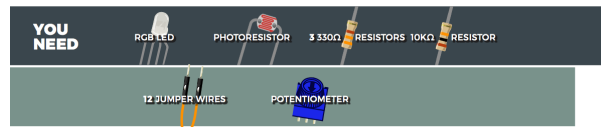

New Components

RGB LED

An RGB LED is actually three small LEDs — one red, one green and one blue — inside a normal LED housing. The RGB LED included in this kit has all the internal LEDs share the same ground wire, so there are four legs in total. To turn one color on, ensure ground is connected, then power one of the legs just as you would a regular LED. If you turn on more than one color at a time, you will see the colors start to blend together to form a new color.



* The longest lead is the common(gnd).

New Concepts

Analog Output (Pulse-width Modulation)

You can use the `digitalWrite()` command to turn pins on the RedBoard on (5V) or off (0V), but what if you want to output 2.5V? The RedBoard doesn't have an Analog Output, but it is really good at switching some digital pins on and off fast enough to simulate an analog output. `analogWrite()` can output 2.5 volts by quickly switching a pin on and off so that the pin is only on 50 percent of the time (50% of 5V is 2.5V). By changing the percent of time that a pin is on, from 0 percent (always off) to 100 percent (always on), `analogWrite()` can output any voltage between 0 and 5V. This is what is known as **pulse-width modulation** (or PWM). By using PWM, you can create many different colors with the RGB LED.

Digital (PWM~): Only a few of the pins on the RedBoard have the circuitry needed to turn on and off fast enough for PWM. These are pins **3, 5, 6, 9, 10 and 11**. Each PWM pin is marked with a ~ on the board. Remember, you can only use `analogWrite()` on these pins.

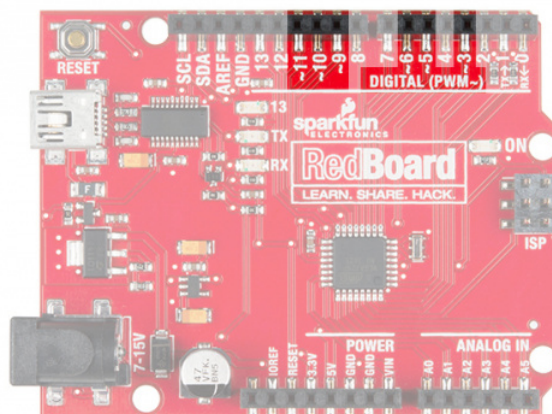

Creating Your Own Simple Functions

When programmers want to use a piece of code over and over again, they write a function. The simplest functions are just chunks of code that you give a name to. When you want to run that code, you can “call” the function by typing its name, instead of writing out all of the code. More complicated functions take and return pieces of information from the program (we call these pieces of information **parameters**). In this circuit, you’ll write functions to turn the RGB LED different colors by just typing that color’s name.

Hardware Hookup

<p>Polarized Components</p> <p>⚠</p>	<p>Pay special attention to the component’s markings indicating how to place it on the breadboard. Polarized components can only be connected to a circuit in one direction.</p>
--------------------------------------	--

Just like a regular LED, an RGB LED is polarized and only allows electricity to flow in one direction. Pay close attention to the flat edge and to the different length leads. Both are indicators to help orient the LED correctly.

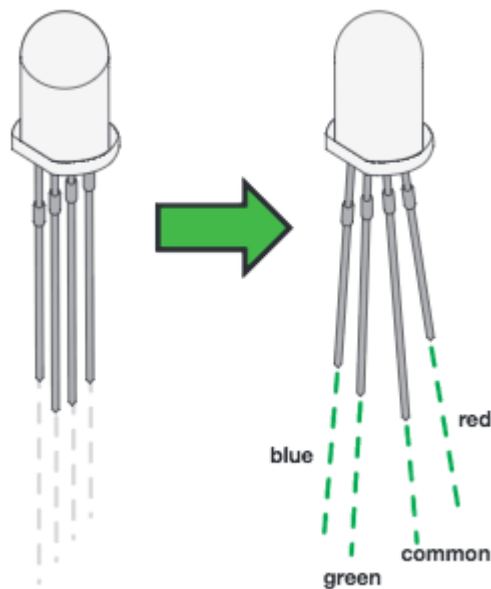

Ready to start hooking everything up? Check out the circuit diagram and hookup table below to see how everything is connected.

Circuit Diagram

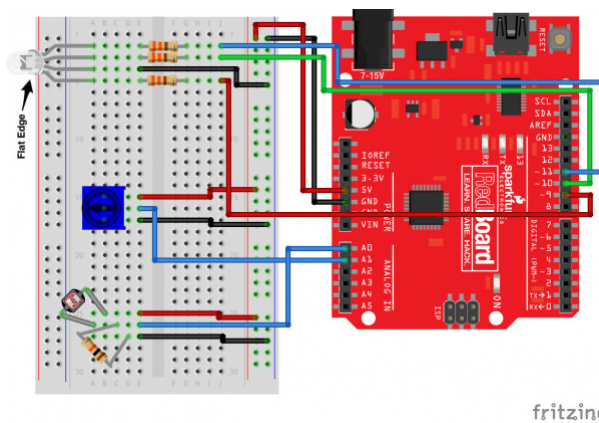

fritzing

Having a hard time seeing the circuit? Click on the image for a closer look.

Hookup Table

--

Component	RedBoard	Breadboard	Breadboard	Breadboard	Breadboard
RGB LED 		A5 (RED)	A4 (GND)	A3 (GREEN)	A2 (BLUE)
330Ω Resistor (orange, orange, brown)		E2	F2		
330Ω Resistor (orange, orange, brown)		E3	F3		
330Ω Resistor (orange, orange, brown)		E5	F5		
Jumper Wire		E4	GND Rail (-)		
Jumper Wire	Digital Pin 9	J5			
Jumper Wire	Digital Pin 10	J3			
Jumper Wire	Digital Pin 11	J2			
Jumper Wire	5V	5V Rail (+)			
Jumper Wire	GND	GND Rail (-)			
Potentiometer		B15	B16	B17	
Jumper Wire	Analog Pin 1 (A1)	E16			
Jumper Wire		E15	5V Rail (+)		
Jumper Wire		E17	GND Rail (-)		
Photoresistor		A26	B25		
10kΩ Resistor (brown, black, orange)		C26	D27		
Jumper Wire	Analog Pin 0 (A0)	E26			
Jumper Wire		E25	5V Rail (+)		
Jumper Wire		E27	GND Rail (-)		

*In the table, polarized components are shown with a warning triangle and the **whole row highlighted yellow**.*

Open the Sketch

To open the code, go to: **File > Examples > SIK_Guide_Code-V_4 > SIK_Circuit_1D-RGBNightlight**

You can also copy and paste the following code into the Arduino IDE. Hit upload, and see what happens!

```

/*
SparkFun Inventor's Kit
Circuit 1D-RGB Nightlight

Turns an RGB LED on or off based on the light level read by a photoresistor.
Change colors by turning the potentiometer.

This sketch was written by SparkFun Electronics, with lots of help from the Arduino community.
This code is completely free for any use.

View circuit diagram and instructions at: https://learn.sparkfun.com/tutorials/sparkfun-inventor-s-kit-experiment-guide---v40
Download drawings and code at: https://github.com/sparkfun/SIK-Guide-Code
*/

int photoresistor;           //variable for storing the photoresistor value
int potentiometer;          //variable for storing the photoresistor value
int threshold = 700;         //if the photoresistor reading is lower than this value the light
                             //will turn on

//LEDs are connected to these pins
int RedPin = 9;
int GreenPin = 10;
int BluePin = 11;

void setup() {
  Serial.begin(9600);        //start a serial connection with the computer

  //set the LED pins to output
  pinMode(RedPin,OUTPUT);
  pinMode(GreenPin,OUTPUT);
  pinMode(BluePin,OUTPUT);
}

void loop() {

  photoresistor = analogRead(A0);           //read the value of the photoresistor
  potentiometer = analogRead(A1);

  Serial.print("Photoresistor value:");
  Serial.print(photoresistor);             //print the photoresistor value to the serial monitor
  Serial.print(" Potentiometer value:");
  Serial.println(potentiometer);           //print the photoresistor value to the serial monitor

  if(photoresistor < threshold){           //if it's dark (the photoresistor value is below the threshold)
    turn the LED on
    //These nested if statements check for a variety of ranges and
    //call different functions based on the current potentiometer value.
    //Those functions are found at the bottom of the sketch.
    if(potentiometer > 0 && potentiometer <= 150)
      red();
    if(potentiometer > 150 && potentiometer <= 300)
      orange();
    if(potentiometer > 300 && potentiometer <= 450)

```

```

    if(potentiometer > 300 && potentiometer <= 450)
        yellow();
    if(potentiometer > 450 && potentiometer <= 600)
        green();
    if(potentiometer > 600 && potentiometer <= 750)
        cyan();
    if(potentiometer > 750 && potentiometer <= 900)
        blue();
    if(potentiometer > 900)
        magenta();
}
else {
    //if it isn't dark turn the LED off

    turnOff();
    //call the turn off function

}

delay(100);
//short delay so that the printout is easier to read
}

void red (){

    //set the LED pins to values that make red
    analogWrite(RedPin, 100);
    analogWrite(GreenPin, 0);
    analogWrite(BluePin, 0);
}

void orange (){

    //set the LED pins to values that make orange
    analogWrite(RedPin, 100);
    analogWrite(GreenPin, 50);
    analogWrite(BluePin, 0);
}

void yellow (){

    //set the LED pins to values that make yellow
    analogWrite(RedPin, 100);
    analogWrite(GreenPin, 100);
    analogWrite(BluePin, 0);
}

void green (){

    //set the LED pins to values that make green
    analogWrite(RedPin, 0);
    analogWrite(GreenPin, 100);
    analogWrite(BluePin, 0);
}

void cyan (){

    //set the LED pins to values that make cyan
    analogWrite(RedPin, 0);
    analogWrite(GreenPin, 100);
    analogWrite(BluePin, 100);
}

```

```

}
void blue (){

    //set the LED pins to values that make blue
    analogWrite(RedPin, 0);
    analogWrite(GreenPin, 0);
    analogWrite(BluePin, 100);
}
void magenta (){

    //set the LED pins to values that make magenta
    analogWrite(RedPin, 100);
    analogWrite(GreenPin, 0);
    analogWrite(BluePin, 100);
}
void turnOff (){

    //set all three LED pins to 0 or OFF
    analogWrite(RedPin, 0);
    analogWrite(GreenPin, 0);
    analogWrite(BluePin, 0);
}
}

```

What You Should See

This sketch is not dissimilar from the last. It reads the value from the photoresistor, compares it to a threshold value, and turns the RGB LED on or off accordingly. This time, however, we've added a potentiometer back into the circuit. When you twist the pot, you should see the color of the RGB LED change based on the pot's value.

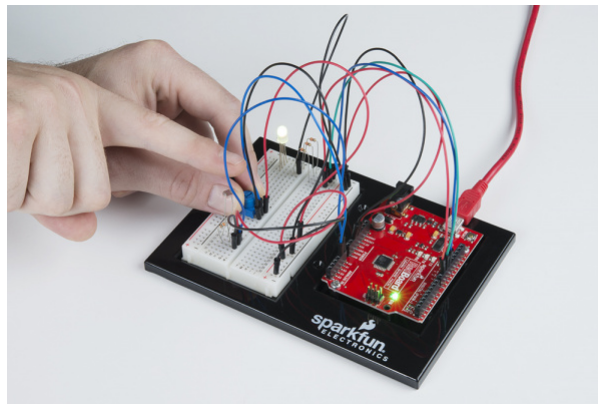

Open the Serial Monitor. The value being read by the light sensor should be printed several times a second. When you turn out the lights or cover the sensor, the LED will shine whatever color your programmed in your color function. Next to the light value, you'll see the potentiometer value print out as well.

Note: If the room you are in is very bright or dark, you may have to change the value of the “threshold” variable in the code to make your night-light turn on and off. See the Troubleshooting section for instructions.

Program Overview

1. Store the light level from pin A0 in the variable `photoresistor` .
2. Store the potentiometer value from pin A1 in the variable `potentiometer` .
3. If the light level variable is above the `threshold` , call the function that turns the RGB LED off.

4. If the light level variable is below the `threshold` , call one of the color functions to turn the RGB LED on.
5. If `potentiometer` is between 0 and 150, turn the RGB LED on red.
6. If `potentiometer` is between 151 and 300, turn the RGB LED on orange.
7. If `potentiometer` is between 301 and 450, turn the RGB LED on yellow.
8. If `potentiometer` is between 451 and 600, turn the RGB LED on green.
9. If `potentiometer` is between 601 and 750, turn the RGB LED on cyan.
10. If `potentiometer` is between 751 and 900, turn the RGB LED on blue.
11. If `potentiometer` is greater than 900, turn the RGB LED on magenta.

Code to Note

Code	Description
Analog Output (PWM): <pre>analogWrite(RedPin, 100);</pre>	The <code>analogWrite()</code> function outputs a voltage between 0 and 5V on a pin. The function breaks the range between 0 and 5V into 255 little steps. Note that we are not turning the LED on to full brightness (255) in this code so that the night-light is not too bright. Feel free to change these values and see what happens.
Nested if Statements: <pre>if(logic statement) { if(logic statement) { code to be run if the logic statement is true} if(logic statement) { code to be run if the logic statement is true} }</pre>	A nested if statement is one or more if statements "nested" inside of another if statement. If the parent if statement is true, then the code looks at each of the nested if statements and executes any that are true. If the parent if statement is false, then none of the nested statements will execute.
More Logical Operators: <pre>if(potentiometer > 0 && potentiometer <= 150)</pre>	These if statements are checking for two conditions by using the AND (<code>&&</code>) operator. In this line, the if statement will only be true if the value of the variable <code>potentiometer</code> is greater than 0 AND if the value is less than or equal to 150. By using <code>&&</code> , the program allows the LED to have many color states.
Defining a Function: <pre>void function_name () { code to run inside function }</pre>	This simple version of a function executes the code inside the curly brackets whenever the name is written in the main program.
Calling a Function: <pre>function_name();</pre>	Calls a function that you have created. In a later circuit, you will learn how to make more complicated functions that take data from the main program (these pieces of data are called parameters).

Coding Challenges

Challenge	Description

Add more colors	You can create many more colors with the RGB LED. Use the <code>analogWrite()</code> function to blend different values of red, green and blue together to make even more colors. You can divide the potentiometer value up more and make more nested if statements so that you can have more colors as you twist the knob.
Multi color blink	Try using delays and multiple color functions to have your RGB LED change between multiple colors.
Change the threshold	Try setting your threshold variable by reading the value of a potentiometer with <code>analogRead()</code> . By turning the potentiometer, you can then change the threshold level and adjust your night-light for different rooms.
Fading the LED	Try using a loop with the <code>analogWrite()</code> to get your LED to pulse gently or smoothly transition between colors.

Troubleshooting

Problem	Solution
The LED never turns on or off	Open the Serial Monitor in Arduino and make sure that your photoresistor is returning values between 0 and 1023. Try covering the photoresistor; the values should change. If they do not change, check the wiring of the photoresistor. If your photoresistor is working correctly, make sure that your threshold variable sits in between the value that the photoresistor reads when it is bright and the value that the photoresistor reads when it is dark (e.g., bright = 850, dark = 600, threshold = 700).
My LED doesn't show the colors that I expect	Make sure that all three of the pins driving your RGB LED are set to <code>OUTPUT</code> , using the <code>pinMode()</code> command in the setup section of the code. Then make sure that each LED is wired properly.
Nothing is printing in the Serial Monitor	Try unplugging your USB cable and plugging it back in. In the Arduino IDE, go to Tools > Port, and make sure that you select the right port.

Project 2: Sound

In Project 2, you will venture into the world of buttons and buzzers while building your own Simon Says game! Simon Says is a game in which the LEDs flash a pattern of red, green, yellow and blue blinks, and the user must recreate the pattern using color-coded buttons before the timer runs out.

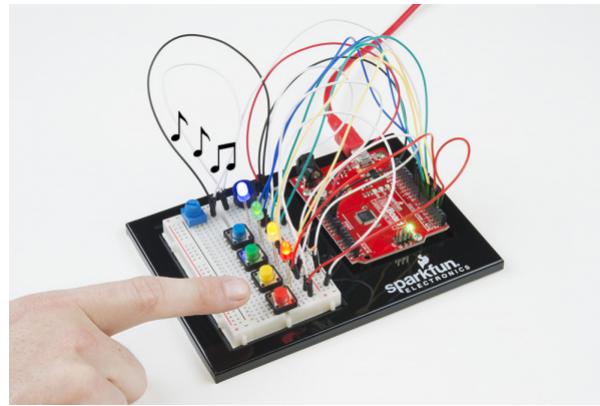

New Components Introduced in This Project

Each of the components listed below will be described in more detail as you progress through each circuit.

- Buzzer
- Buttons

New Concepts Introduced in This Project

Each of the concepts listed below will be described in more detail as you progress through each circuit.

- Arrays
- Binary
- Digital Inputs
- Pull-up Resistors
- For Loops
- Measuring Elapsed Time

You Will Learn

- How to make tones with a buzzer
- How to read a button using digital inputs
- How to program a game

Circuit 2A: Buzzer

In this circuit, you'll use the RedBoard and a small buzzer to make music, and you'll learn how to program your own songs using arrays.

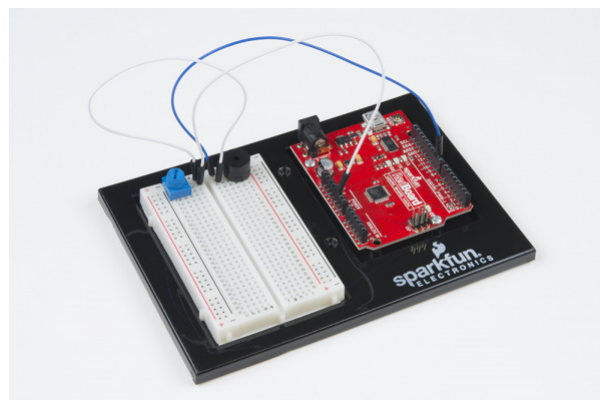

Parts Needed

Grab the following quantities of each part listed to build this circuit:



New Components

Buzzer

The buzzer uses a small magnetic coil to vibrate a metal disc inside a plastic housing. By pulsing electricity through the coil at different rates, different frequencies (itches) of sound can be produced. Attaching a potentiometer to the output allows you to limit the amount of current moving through the buzzer and lower its volume.



New Concepts

Reset Button

The RedBoard has a built-in reset button. This button will reset the board and start the code over from the beginning, running what is in `setup()` and then `loop()` .

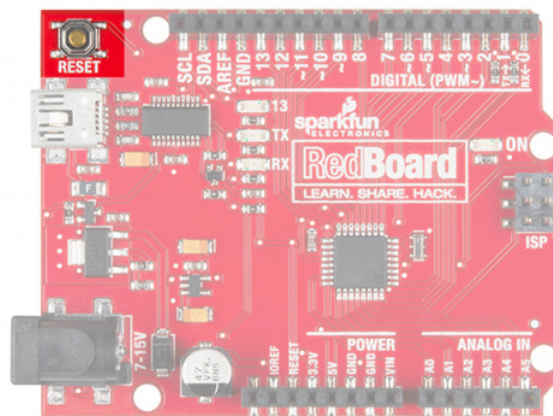

Tone Function

To control the buzzer, you will use the tone function. This function is similar to PWM in that it generates a wave that is of a certain frequency on the specified pin. The frequency and duration can both be passed to the `tone()` function when calling it. To turn the tone off, you need to call `noTone()` or pass a duration of time for it to play and then stop. Unlike PWM, `tone()` can be used on any digital pin.

Arrays

Arrays are used like variables, but they can store multiple values. The simplest array is just a list. Imagine that you want to store the frequency for each note of the C major scale. We could make seven variables and assign a frequency to each one, or we could use an array and store all seven in the same array, as shown below. To refer to a specific value in the array, an index number is used. Arrays are indexed from 0. For example, to call the first element in the array, use `array_name[0]`; to call the second element, use `array_name[1]`; and so on.

Musical Note	Frequency (Hz)	Using Variables	Using an Array
A	220	aFrequency	frequency[0]
B	247	bFrequency	frequency[1]
C	261	cFrequency	frequency[2]
D	294	dFrequency	frequency[3]
E	330	eFrequency	frequency[4]
F	349	fFrequency	frequency[5]
G	392	gFrequency	frequency[6]

Hardware Hookup

Polarized Components ⚠	Pay special attention to the component's markings indicating how to place it on the breadboard. Polarized components can only be connected to a circuit in one direction.
---------------------------	---

The buzzer is polarized. To see which leg is positive and which is negative, flip the buzzer over and look at the markings underneath. Keep track of which pin is where, as they will be hard to see once inserted into the breadboard. There is also text on the positive side of the buzzer, along with a tiny (+) symbol.





Volume Knob

All of the circuits in Project 2 make use of a potentiometer as a rudimentary volume knob. Notice that only two of the potentiometer's legs are used in these circuits. In these instances, the potentiometer is acting as a variable resistor, limiting the amount of current flowing to the speaker and thus affecting the volume as you turn the knob. This is similar to the current-limiting resistor used to limit current to the LED in circuit 1A — only this time the resistance is variable.

Ready to start hooking everything up? Check out the circuit diagram and hookup table below to see how everything is connected.

Circuit Diagram

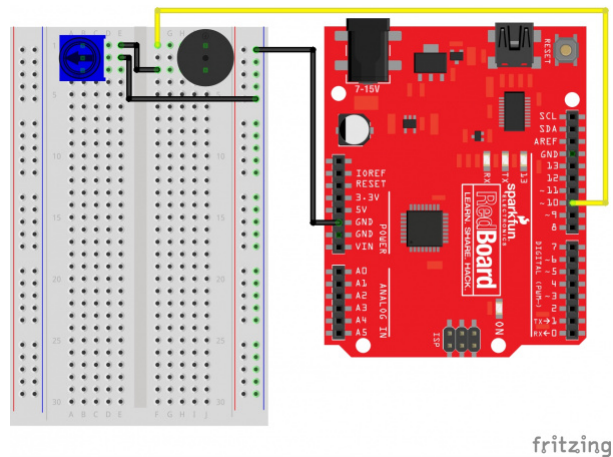

Having a hard time seeing the circuit? Click on the image for a closer look.

Hookup Table

Component	RedBoard	Breadboard	Breadboard	Breadboard
Buzzer 		J1 (Buzzer +)	J3 (Buzzer -)	
Potentiometer		B1	B2	B3
Jumper Wire	GND	GND Rail (-)		
Jumper Wire	Digital Pin 10	F1		
Jumper Wire		E2	GND Rail (-)	
Jumper Wire		E1	F3	

*In the table, polarized components are shown with a warning triangle and the **whole row** highlighted **yellow**.*

Open the Sketch

To open the code, go to: **File > Examples > SIK_Guide_Code-V_4 > SIK_Circuit_2A-Buzzer**

You can also copy and paste the following code into the Arduino IDE. Hit upload, and see what happens!

```

/*
SparkFun Inventor's Kit
Circuit 2A - Buzzer

Play notes using a buzzer connected to pin 10

This sketch was written by SparkFun Electronics, with lots of help from the Arduino community.
This code is completely free for any use.

View circuit diagram and instructions at: https://learn.sparkfun.com/tutorials/sparkfun-inventor-s-kit-experiment-guide---v40
Download drawings and code at: https://github.com/sparkfun/SIK-Guide-Code
*/

int speakerPin = 10;           //the pin that buzzer is connected to

void setup()
{
  pinMode(speakerPin, OUTPUT); //set the output pin for the speaker
}

void loop()
{
  play('g', 2);      //ha
  play('g', 1);      //ppy
  play('a', 4);      //birth
  play('g', 4);      //day
  play('C', 4);      //to
  play('b', 4);      //you

  play(' ', 2);      //pause for 2 beats

  play('g', 2);      //ha
  play('g', 1);      //ppy
  play('a', 4);      //birth
  play('g', 4);      //day
  play('D', 4);      //to
  play('C', 4);      //you

  play(' ', 2);      //pause for 2 beats

  play('g', 2);      //ha
  play('g', 1);      //ppy
  play('G', 4);      //birth
  play('E', 4);      //day
  play('C', 4);      //dear
  play('b', 4);      //your
  play('a', 6);      //name

  play(' ', 2);      //pause for 2 beats

```

```

play('F', 2);      //ha
play('F', 1);      //ppy
play('E', 4);      //birth
play('C', 4);      //day
play('D', 4);      //to
play('C', 6);      //you

while(true){      //get stuck in this loop forever so that the song only plays once
}

void play( char note, int beats)
{
    int numNotes = 14; // number of notes in our note and frequency array (there are 15 values, but arrays start at 0)

    //Note: these notes are C major (there are no sharps or flats)

    //this array is used to look up the notes
    char notes[] = { 'c', 'd', 'e', 'f', 'g', 'a', 'b', 'C', 'D', 'E', 'F', 'G', 'A', 'B', ' ' };
    //this array matches frequencies with each letter (e.g. the 4th note is 'f', the 4th frequency is 175)
    int frequencies[] = {131, 147, 165, 175, 196, 220, 247, 262, 294, 330, 349, 392, 440, 494, 0};

    int currentFrequency = 0; //the frequency that we find when we look up a frequency in the arrays
    int beatLength = 150; //the length of one beat (changing this will speed up or slow down the tempo of the song)

    //look up the frequency that corresponds to the note
    for (int i = 0; i < numNotes; i++) // check each value in notes from 0 to 14
    {
        if (notes[i] == note) // does the letter passed to the play function match the letter in the array?
        {
            currentFrequency = frequencies[i]; // Yes! Set the current frequency to match that note
        }
    }

    //play the frequency that matched our letter for the number of beats passed to the play function
    tone(speakerPin, currentFrequency, beats * beatLength);
    delay(beats* beatLength); //wait for the length of the tone so that it has time to play
    delay(50); //a little delay between the notes makes the song sound more natural
}

/* CHART OF FREQUENCIES FOR NOTES IN C MAJOR
Note      Frequency (Hz)
c         131
d         147
e         165
f         175

```

g	196
a	220
b	247
C	262
D	294
E	330
F	349
G	392
A	440
B	494
*/	

What You Should See

When the program begins, a song will play from the buzzer once. To replay the song, press the reset button on the RedBoard. Use the potentiometer to adjust the volume.

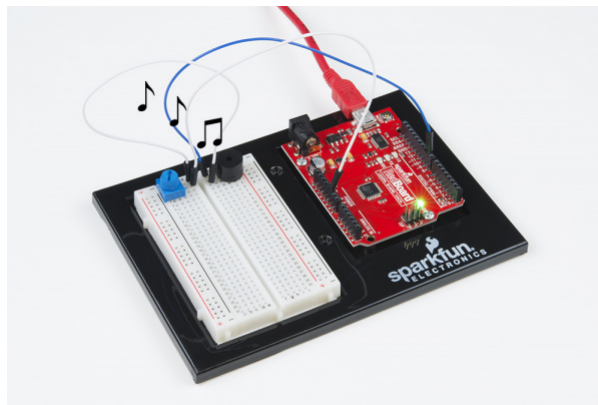

Program Overview

Inside the main loop:

1. Play the first note for x number of beats using the play function.
 - a. (Inside the play function:) Take the note passed to the play function and compare it to each letter in the notes array. When you find a note that matches, remember the index position of that note (e.g., 6th entry in the notes array).
 - b. Get a frequency from the frequency array that has the same index as the note that matched (e.g., the 6th frequency).
 - c. Play that frequency for the number of beats passed to the play function.
2. Play the second note using the play function
...and so on.

Code to Note

Code	Description
------	-------------

<p>Character Variables:</p> <pre>void play(char note, int beats)</pre>	<p>The char, or character, variable to store character values. For example, in this sketch, the <code>play()</code> function gets passed two variables, a character variable that represents the musical note we want to play and an integer variable that represents how long to play that note. A second array takes the character variable and associates a frequency value to it. This makes programming a song easier as you can just reference the character and not the exact frequency.</p>
<p>Tone Function:</p> <pre>tone(pin, frequency, duration);</pre>	<p>The <code>tone()</code> function will pulse power to a pin at a specific frequency. The duration controls how long the sound will play. Tone can be used on any digital pin.</p>
<p>Declaring an Array:</p> <pre>array_name[array_size]; or array_name[] = {array elements};</pre>	<p>To declare an array, you must give it a name, then either tell Arduino how many positions the array will have or assign a list of values to the array.</p>
<p>Calling an Array:</p> <pre>array_name[index #];</pre>	<p>To call one of the values in an array, simply type the name of the array and the index of the value. You can use a variable instead of a number in between the square brackets. Don't forget the index starts at 0, not 1, so to call the first element, use <code>array_name[0];</code> .</p>

Coding Challenges

Challenge	Description
Change the tempo of the song	Experiment with the <code>beatLength;</code> variable to change the tempo of the song.
Make your own song	Try changing the notes to make a different song. Spaces " " can be used for rests in the song.

Troubleshooting

Problem	Solution
The song is too quiet or too loud	Turn the potentiometer to adjust the volume.
No sound is playing	Try pressing the reset button on the RedBoard. If that doesn't work, check your wiring of the buzzer. It's easy to misalign a pin with a jumper wire.

Circuit 2B: Digital Trumpet

Learn about digital inputs and buttons as you build your own digital trumpet!

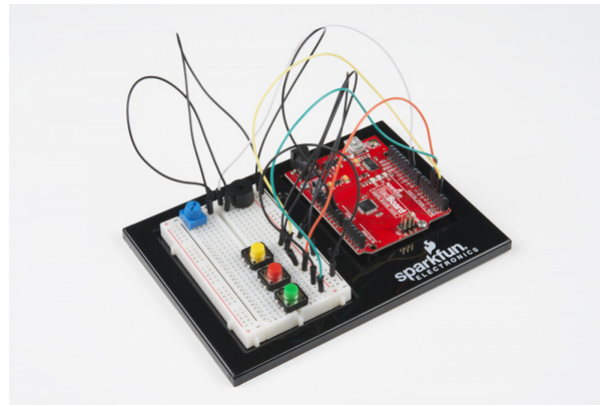

Parts Needed

Grab the following quantities of each part listed to build this circuit:

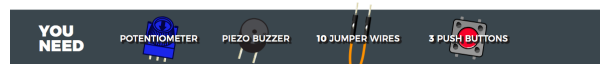

New Components

Buttons

Buttons, also known as momentary switches, are switches that only remain in their on state as long as they're being actuated, or pressed. Most often momentary switches are best used for intermittent user-input cases: reset button and keypad buttons. These switches have a nice, tactile, “clicky” feedback when you press them.



Note that the different colors are just aesthetic. All of the buttons included behave the same no matter their color.

New Concepts

Binary Number System

Number systems are the methods we use to represent numbers. We've all been mostly operating within the comfy confines of a base-10 number system, but there are many others. The base-2 system, otherwise known as binary, is common when dealing with computers and electronics. There are really only two ways to represent the state of anything: ON or OFF, HIGH or LOW, 1 or 0. And so, almost all electronics rely on a base-2 number system to store and manipulate numbers. The heavy reliance electronics places on binary numbers means it's important to know how the base-2 number system works.

Digital Input

In circuit 1A, you worked with digital outputs. This circuit focuses on digital inputs. Digital inputs only care if something is in one of two states: TRUE or FALSE, HIGH or LOW, ON or OFF. Digital inputs are great for determining if a button has been pressed or if a switch has been flipped.

Pull-up Resistors

A pull-up resistor is a small circuit that holds the voltage HIGH (5V) on a pin until a button is pressed, pulling the voltage LOW (0V). The most common place you will see a pull-up resistor is when working with buttons. A pull-up resistor keeps the button in one state until it is pressed. The RedBoard has built-in pull-up resistors, but they can also be added to a circuit externally. This circuit uses the internal pull-up resistors, covered in more detail in the Code to Note section.

Hardware Hookup

Buttons are not polarized. However, they do merit a closer look. Buttons make momentary contact from one connection to another, so why are there four legs on each button? The answer is to provide more stability and support to the buttons in your breadboard circuit. Each row of legs is connected internally. When the button is pressed, one row connects to the other, making a connection between all four pins.

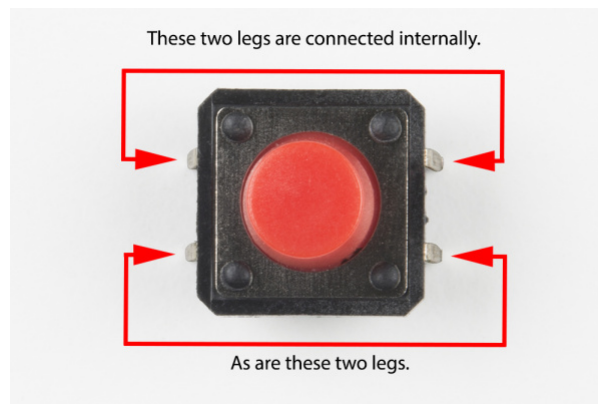

If the button's legs don't line up with the slots on the breadboard, rotate it 90 degrees.

Ready to start hooking everything up? Check out the circuit diagram and hookup table below to see how everything is connected.

Circuit Diagram

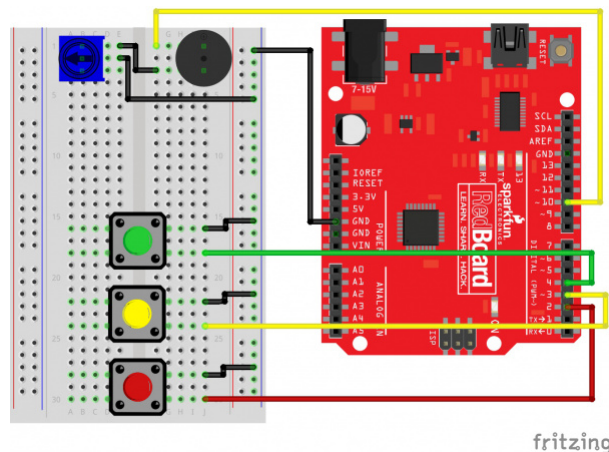

Having a hard time seeing the circuit? Click on the image for a closer look.

Hookup Table

Component	RedBoard	Breadboard	Breadboard	Breadboard
Buzzer 		J1 (Buzzer +)	J3 (Buzzer -)	

Potentiometer		B1	B2	B3
Jumper Wire	GND	GND Rail (-)		
Jumper Wire	Digital Pin 10	F1		
Jumper Wire		E2	GND Rail (-)	
Jumper Wire		E1	F3	
Push Button		D16/D18	G16/G18	
Push Button		D22/D24	G22/G24	
Push Button		D28/D30	G28/G30	
Jumper Wire	Digital Pin 4	J18		
Jumper Wire	Digital Pin 3	J24		
Jumper Wire	Digital Pin 2	J30		
Jumper Wire		J16	GND Rail (-)	
Jumper Wire		J22	GND Rail (-)	
Jumper Wire		J28	GND Rail (-)	

*In the table, polarized components are shown with a warning triangle and the **whole row** highlighted **yellow**.*

Open the Sketch

To open the code, go to: **File > Examples > SIK_Guide_Code-V_4 > SIK_Circuit_2B-ButtonTrumpet**

You can also copy and paste the following code into the Arduino IDE. Hit upload, and see what happens!

```

/*
SparkFun Inventor's Kit
Circuit 2B-DigitalTrumpet

Use 3 buttons plugged to play musical notes on a buzzer.

This sketch was written by SparkFun Electronics, with lots of help from the Arduino community.
This code is completely free for any use.

View circuit diagram and instructions at: https://learn.sparkfun.com/tutorials/sparkfun-inventor-s-kit-experiment-guide---v40
Download drawings and code at: https://github.com/sparkfun/SIK-Guide-Code
*/

//set the pins for the button and buzzer
int firstKeyPin = 2;
int secondKeyPin = 3;
int thirdKeyPin = 4;

int buzzerPin = 10;

void setup() {
  //set the button pins as inputs
  pinMode(firstKeyPin, INPUT_PULLUP);
  pinMode(secondKeyPin, INPUT_PULLUP);
  pinMode(thirdKeyPin, INPUT_PULLUP);

  //set the buzzer pin as an output
  pinMode(buzzerPin, OUTPUT);
}

void loop() {

  if(digitalRead(firstKeyPin) == LOW){          //if the first key is pressed
    tone(buzzerPin, 262);                       //play the frequency for c
  }
  else if(digitalRead(secondKeyPin) == LOW){   //if the second key is pressed
    tone(buzzerPin, 330);                       //play the frequency for e
  }
  else if(digitalRead(thirdKeyPin) == LOW){    //if the third key is pressed
    tone(buzzerPin, 392);                       //play the frequency for g
  }
  else{
    noTone(buzzerPin);                          //if no key is pressed turn the buzzer off
  }
}

/*
note  frequency
c      262 Hz
d      294 Hz
e      330 Hz
f      348 Hz

```

T	549 Hz
g	392 Hz
a	440 Hz
b	494 Hz
C	523 Hz
*/	

What You Should See

Different tones will play when you press different keys. Turning the potentiometer will adjust the volume.

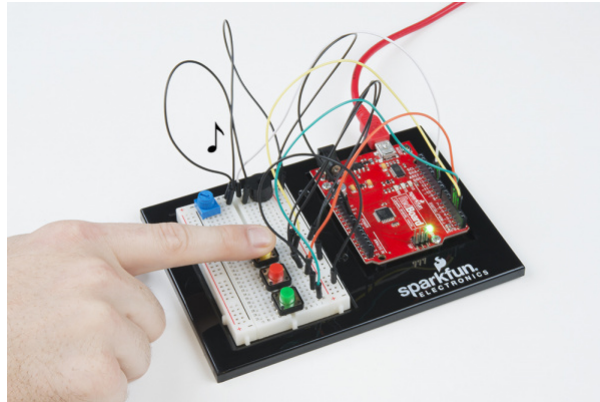

Program Overview

1. Check to see if the first button is pressed.
 - a. If it is, play the frequency for c.
 - b. If it isn't, skip to the next **else if** statement.
2. Check to see if the second button is pressed.
 - a. If it is, play the frequency for e.
 - b. If it isn't, skip to the next **else if** statement.
3. Check to see if the second button is pressed.
 - a. If it is, play the frequency for g.
 - b. If it isn't, skip to the next **else if** statement.
4. If none of the **if** statements are true
 - a. Turn the buzzer off.

Code to Note

Code	Description
Internal Pull-Up Resistor: <pre>pinMode(firstKeyPin, INPUT_PULLUP);</pre>	To declare a standard input, use the line <code>pinMode(pin_name, INPUT)</code> . If you would like to use one of the RedBoard's built-in pull-up 20kΩ resistors, it would look like this: <pre>pinMode(firstKeyPin, INPUT_PULLUP);</pre> . The advantage of external pull-ups is being able to choose a more exact value for the resistor.
Digital Input: <pre>digitalRead(pin);</pre>	Check to see if an input pin is reading HIGH (5V) or LOW (0V). Returns TRUE (1) or FALSE (0) depending on the reading.

<p>Is Equal to:</p> <pre>if(digitalRead(firstKeyPin) == LOW)</pre>	<p>This is another logical operator. The 'is equal to' symbol (==) can be confusing. Two equals signs are equivalent to asking, "Are these two values equal to one another?" On the other hand, one equals sign in code is assigning a particular variable to a value. Don't forget to add the second equals sign if you are comparing two values.</p>
--	--

Coding Challenges

Challenge	Description
Change the key of each button	Use the frequency table in the comment section at the end of the code to change the notes that each button plays.
Play more than three notes with if statements	By using combinations of buttons, you can play up to seven notes of the scale. You can do this in a few ways. To get more practice with if statements, try adding seven if statements and using the Boolean AND (&&) operator to represent all of the combinations of keys.
Play more than three notes with binary math	You can use a clever math equation to play more than three notes with your three keys. By multiplying each key by a different number, then adding up all of these numbers, you can make a math equation that produces a different number for each combination of keys.

Troubleshooting

Problem	Solution
The buzzer is too loud or too quiet	Turn the potentiometer to adjust the volume.
The RedBoard thinks one key is always pressed	Check your wiring. You may have ground and 5V backward if one or more buttons behave as though they're pressed all the time.
The buttons are not working	First, make sure that the wiring is correct. It is easy to misalign a wire with a button leg. Second, make sure that you have declared your buttons as inputs and have enabled the internal pull-up resistors with <code>INPUT_PULLUP</code> .

Circuit 2C: Simon Says Game

The Simon Says game uses LEDs to flash a pattern, which the player must remember and repeat using four buttons. The classic Simon game has been a hit since the 1980s. Now you can build your own!

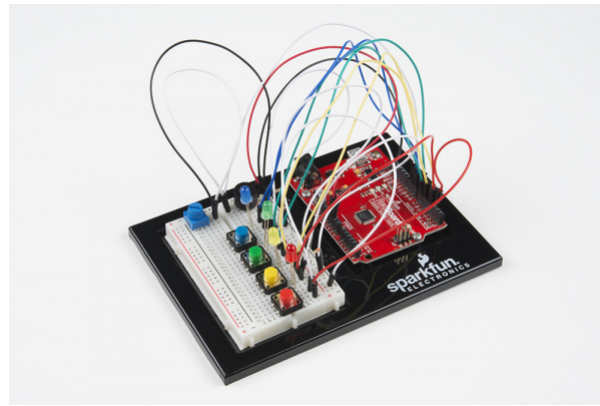

Parts Needed

Grab the following quantities of each part listed to build this circuit:



New Concepts

For Loops

For loops repeat a section of code a set number of times. The loop works by using a counter (usually programmers use the letter “i” for this variable) that increases each loop until it reaches a stop value. Here’s an example of a simple for loop:

```
for (int i = 0; i < 5; i++){  
  Serial.print(i);  
}
```

The for loop takes three parameters in the brackets, separated by semicolons. The first parameter is the start value. In this case, integer `i` starts at 0. The second value is the stop condition. In this case, we stop the loop when `i` is no longer less than 5 (`i < 5` is no longer true). The final parameter is an increment value. `i++` is shorthand for increase `i` by 1 each time, but you could also increase `i` by different amounts. This loop would repeat five times. Each time it would run the code in between the brackets, which prints the value of `i` to the serial monitor.

Measuring Durations of Time With `millis()`

The RedBoard has a built-in clock that keeps accurate time. You can use the `millis()` command to see how many milliseconds have passed since the RedBoard was last powered. By storing the time when an event happens and then subtracting the current time, you can measure the number of milliseconds (and thus seconds) that have passed. This sketch uses this function to set a time limit for repeating the pattern.

Custom Functions

This sketch uses several user-defined functions. These functions perform operations that are needed many times in the program (for example, reading which button is currently pressed or turning all of the LEDs off). Functions are essential to make more complex programs readable and compact.

Hardware Hookup

Ready to start hooking everything up? Check out the circuit diagram and hookup table below to see how everything is connected.

Circuit Diagram

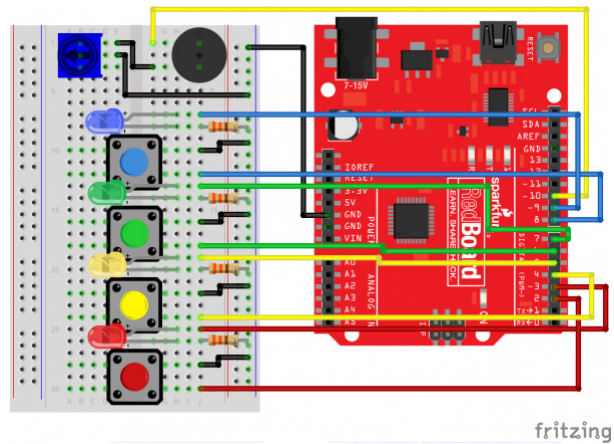

Having a hard time seeing the circuit? Click on the image for a closer look.

Hookup Table

Component	RedBoard	Breadboard	Breadboard	Breadboard
Buzzer 		J1 (Buzzer +)	J3 (Buzzer -)	
Potentiometer		B1	B2	B3
Jumper Wire	GND	GND Rail (-)		
Jumper Wire	Digital Pin 10	F1		
Jumper Wire		E2	GND Rail (-)	
Jumper Wire		E1	F3	
Push Button		D10/D12	G10/G12	
Push Button		D16/D18	G16/G18	
Push Button		D22/D24	G22/G24	
Push Button		D28/D30	G28/G30	
Jumper Wire	Digital Pin 8	J12		
Jumper Wire	Digital Pin 6	J18		
Jumper Wire	Digital Pin 4	J24		
Jumper Wire	Digital Pin 2	J30		
Jumper Wire		J10	GND Rail (-)	

Jumper Wire		J16	GND Rail (-)	
Jumper Wire		J22	GND Rail (-)	
Jumper Wire		J28	GND Rail (-)	
Blue LED ⚠		H7 LED (+)	H8 LED (-)	
Green LED ⚠		H13 LED (+)	H14 LED (-)	
Yellow LED ⚠		H19 LED (+)	H20 LED (-)	
Red LED ⚠		H25 LED (+)	H26 LED (-)	
Jumper Wire	Digital Pin 9	J7		
Jumper Wire	Digital Pin 7	J13		
Jumper Wire	Digital Pin 5	J19		
Jumper Wire	Digital Pin 3	J25		
330Ω Resistor (orange, orange, brown)		J8	GND Rail (-)	
330Ω Resistor (orange, orange, brown)		J14	GND Rail (-)	
330Ω Resistor (orange, orange, brown)		j20	GND Rail (-)	
330Ω Resistor (orange, orange, brown)		J26	GND Rail (-)	

*In the table, polarized components are shown with a warning triangle and the **whole row highlighted yellow**.*

Open the Sketch

To open the code, go to: **File > Examples > SIK_Guide_Code-V_4 > SIK_Circuit_2C-SimonSays**

You can also copy and paste the following code into the Arduino IDE. Hit upload, and see what happens!

```

/*
SparkFun Inventor's Kit
Circuit 2C-Simon Says

The Simon Says game flashes a pattern using LED lights, then the player must repeat the pattern.

This sketch was written by SparkFun Electronics, with lots of help from the Arduino community.
This code is completely free for any use.

View circuit diagram and instructions at: https://learn.sparkfun.com/tutorials/sparkfun-inventor-s-kit-experiment-guide---v40
Download drawings and code at: https://github.com/sparkfun/SIK-Guide-Code
*/

//set the pins where the buttons, LEDs and buzzer connect
int button[] = {2,4,6,8};    //red is button[0], yellow is button[1], green is button[2], blue
                             //is button[3]
int led[] = {3,5,7,9};      //red is led[0], yellow is led[1], green is led[2], blue is led[3]
int tones[] = {262, 330, 392, 494}; //tones to play with each button (c, e, g, b)

int roundsToWin = 10;       //number of rounds the player has to play before they win the game
                             //(the array can only hold up to 16 rounds)
int buttonSequence[16];     //make an array of numbers that will be the sequence that the player
                             //needs to remember

int buzzerPin = 10;         //pin that the buzzer is connected to

int pressedButton = 4;      //a variable to remember which button is being pressed. 4 is the v
                             //alue if no button is being pressed.
int roundCounter = 1;       //keeps track of what round the player is on

long startTime = 0;         //timer variable for time limit on button press
long timeLimit = 2000;     //time limit to hit a button

boolean gameStarted = false; //variable to tell the game whether or not to play the start s
                             //equence

void setup(){

    //set all of the button pins to input_pullup (use the builtin pullup resistors)
    pinMode(button[0], INPUT_PULLUP);
    pinMode(button[1], INPUT_PULLUP);
    pinMode(button[2], INPUT_PULLUP);
    pinMode(button[3], INPUT_PULLUP);

    //set all of the LED pins to output
    pinMode(led[0], OUTPUT);
    pinMode(led[1], OUTPUT);
    pinMode(led[2], OUTPUT);
    pinMode(led[3], OUTPUT);

    pinMode(buzzerPin, OUTPUT); //set the buzzer pin to output

```

```

,
void loop(){

if (gameStarted == false){    //if the game hasn't started yet
    startSequence();           //flash the start sequence
    roundCounter = 0;         //reset the round counter
    delay(1500);              //wait a second and a half
    gameStarted = true;       //set gameStarted to true so that this sequence doesn't start again
}

//each round, start by flashing out the sequence to be repeated
for(int i=0; i <= roundCounter; i++){ //go through the array up to the current round number
    flashLED(buttonSequence[i]);      //turn on the LED for that array position and play the sound
    delay(200);                       //wait
    allLEDOff();                      //turn all of the LEDs off
    delay(200);
}

//then start going through the sequence one at a time and see if the user presses the correct button
for(int i=0; i <= roundCounter; i++){ //for each button to be pressed in the sequence

    startTime = millis();             //record the start time

    while(true){ //loop until the player presses a button or the time limit is up (the time limit check is in an if statement)

        pressedButton = buttonCheck(); //every loop check to see which button is pressed

        if (pressedButton < 4){ //if a button is pressed... (4 means that no button is pressed)

            flashLED(pressedButton); //flash the LED for the button that was pressed

            if(pressedButton == buttonSequence[i]){ //if the button matches the button in the sequence
                delay(250); //leave the LED light on for a moment
                allLEDOff(); //then turn off all of the lights and
                break; //end the while loop (this will go to the next number in the for loop)
            } else{ //if the button doesn't match the button in the sequence
                loseSequence(); //play the lose sequence (the lose sequence stops the program)
                break; //when the program gets back from the lose sequence, break the while loop so that the game can start over
            }
        } else { //if no button is pressed
            allLEDOff(); //turn all the LEDs off
        }
    }
}

```

```

    //check to see if the time limit is up
    if(millis() - startTime > timeLimit){ //if the time limit is up
        loseSequence(); //play the lose sequence
        break; //when the program gets back from the lose sequence,
break the while loop so that the game can start over
    }
}
}

roundCounter = roundCounter + 1; //increase the round number by 1

if (roundCounter >= roundsToWin){ //if the player has gotten to the 16th round
    winSequence(); //play the winning song
}

delay(500); //wait for half a second between rounds

}

//-----FUNCTIONS-----

//FLASH LED
void flashLED (int ledNumber){
    digitalWrite(led[ledNumber], HIGH);
    tone(buzzerPin, tones[ledNumber]);
}

//TURN ALL LEDS OFF
void allLEDoft (){
    //turn all the LEDs off
    digitalWrite(led[0],LOW);
    digitalWrite(led[1],LOW);
    digitalWrite(led[2],LOW);
    digitalWrite(led[3],LOW);
    //turn the buzzer off
    noTone(buzzerPin);
}

//CHECK WHICH BUTTON IS PRESSED
int buttonCheck(){
    //check if any buttons are being pressed
    if(digitalRead(button[0]) == LOW){
        return 0;
    }else if(digitalRead(button[1]) == LOW){
        return 1;
    }else if(digitalRead(button[2]) == LOW){
        return 2;
    }else if(digitalRead(button[3]) == LOW){
        return 3;
    }else{
        return 4; //this will be the value for no button being pressed
    }
}
}

```

J

```
//START SEQUENCE
void startSequence(){

    randomSeed(analogRead(A0)); //make sure the random numbers are really random

    //populate the buttonSequence array with random numbers from 0 to 3
    for (int i=0;i<=roundsToWin;i++){
        buttonSequence[i] = round(random(0,4));
    }

    //flash all of the LEDs when the game starts
    for(int i=0; i<=3; i++){

        tone(buzzerPin, tones[i], 200); //play one of the 4 tones

        //turn all of the leds on
        digitalWrite(led[0],HIGH);
        digitalWrite(led[1],HIGH);
        digitalWrite(led[2],HIGH);
        digitalWrite(led[3],HIGH);

        delay(100); //wait for a moment

        //turn all of the leds off
        digitalWrite(led[0],LOW);
        digitalWrite(led[1],LOW);
        digitalWrite(led[2],LOW);
        digitalWrite(led[3],LOW);

        delay(100); //wait for a moment

    } //this will repeat 4 times
}

//WIN SEQUENCE
void winSequence(){

    //turn all the LEDs on
    for(int j=0; j<=3; j++){
        digitalWrite(led[j], HIGH);
    }

    //play the 1Up noise
    tone(buzzerPin, 1318, 150); //E6
    delay(175);
    tone(buzzerPin, 1567, 150); //G6
    delay(175);
    tone(buzzerPin, 2637, 150); //E7
    delay(175);
    tone(buzzerPin, 2093, 150); //C7
    delay(175);
    tone(buzzerPin, 2349, 150); //D7
    delay(175);
}
```

```

delay(175);
tone(buzzerPin, 3135, 500); //G7
delay(500);

//wait until a button is pressed
do {
  pressedButton = buttonCheck();
} while(pressedButton > 3);
delay(100);

gameStarted = false; //reset the game so that the start sequence will play again.
}

//LOSE SEQUENCE
void loseSequence(){

//turn all the LEDs on
for(int j=0; j<=3; j++){
  digitalWrite(led[j], HIGH);
}

//play the 1Up noise
tone(buzzerPin, 130, 250); //E6
delay(275);
tone(buzzerPin, 73, 250); //G6
delay(275);
tone(buzzerPin, 65, 150); //E7
delay(175);
tone(buzzerPin, 98, 500); //C7
delay(500);

//wait until a button is pressed
do {
  pressedButton = buttonCheck();
} while(pressedButton > 3);
delay(200);

gameStarted = false; //reset the game so that the start sequence will play again.
}

```

What You Should See

The circuit will flash all of the LEDs and play a melody. After a few seconds, it will flash the first light in the pattern. If you repeat the pattern correctly by pressing the corresponding colored button, then the game will move to the next round and add another color to the pattern sequence. If you make a mistake, the loss melody will play. If you get to round 10, the win melody will play. Press any button to start a new game.

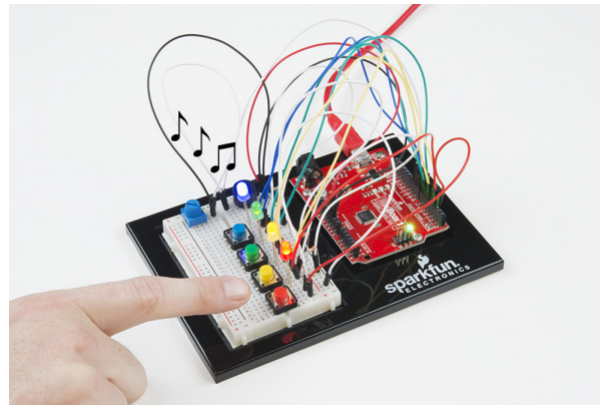

Program Overview

1. Check if a new game is starting. If it is, play the start sequence. Reset the counter that keeps track of rounds, and randomly generate a sequence of numbers from 0 to 3 that control which LEDs the user will have to remember.
2. The game works in rounds that progress from 0 to 10. Each round the game will flash LEDs in a pattern, then the player has to recreate the pattern by pressing the button(s) that match the LED(s). In the first round, one LED will flash, and the player will have to press one button. In the eighth round, eight LEDs will flash, and the player will have to press eight buttons.
3. Use a loop to flash LEDs from the sequence until you have flashed the number of LEDs that matches the round number (1 for round 1, 2 for round 2, etc).
4. Start a timer, and wait for the player to press a button. The player has 1.5 seconds to press the correct button.
 - a. If the time limit runs out before a button is pressed, the player loses.
 - b. If the player presses the wrong button, the player loses.
 - c. If the player presses the right button, move on to the next number in the sequence.
 - d. Repeat this process until the player has lost or correctly repeated the sequence for this round.
5. If the player repeats the entire sequence for that round. Increase the round number by one (this will add one extra item to the end of the pattern). Then go back to step 3.
6. Keep incrementing the round until the player loses or the player finishes 10 rounds. If the player finishes 10 rounds, play the winning sequence.

Code to Note

Code	Description
Elapsed Time: <code>millis();</code>	The <code>millis</code> function returns the number of milliseconds that have passed since the RedBoard was last turned on.
Boolean Variables: <code>boolean variable_name;</code>	The name for these variables comes from Boolean logic. The Boolean variable type only has two values: 1 or 0, HIGH or LOW, TRUE or FALSE. Using Boolean variables helps save memory on your microcontroller if you only need to know if something is true or false. Space in your microcontroller's memory is reserved when a variable is declared. How much memory is reserved depends on the type of variable.

Storing pin numbers in Arrays: <code>int led[] = {3,5,7,9};</code>	Sometimes you will want to cycle through all of the LEDs or buttons connected to a project. You can do this by storing a sequence of pin numbers in an array. The advantage of having pins in an array instead of a sequence of variables is that you can use a loop to easily cycle through each pin.
User Functions	Description
<code>flashLED(# for LED to flash);</code>	This turns one of the four LEDs on and plays the tone associated with it. 0 = Red, 1 = Yellow, 2 = Green, 3 = Blue.
<code>allLEDOff();</code>	Turns all four LEDs off.
<code>buttonCheck();</code>	Uses <code>digitalRead()</code> to check which button is pressed. Returns 0, 1, 2 or 3 if one of the buttons is pressed. Returns 4 if no button is pressed.
<code>startSequence();</code>	Flashes the LEDs and plays tones in a sequence. Resets the round counter and generates a new random sequence for the user to remember.
<code>winSequence();</code>	Plays a sequence of tones, turns all of the LEDs on, then waits for the player to press a button. If a button is pressed, restarts the game.
<code>loseSequence();</code>	Plays a sequence of tones, turns all of the LEDs on, then waits for the player to press a button. If a button is pressed, restarts the game.

Coding Challenges

Challenge	Description
Change the difficulty of the game	Change the difficulty of the game by changing how fast the player has to press each button or by increasing or decreasing the number of rounds needed to win. Note that if you increase the number of rounds to be larger than 16, you will need to change the size of the “buttonSequence” array (it is set at the top of the code in a line that looks like this: <code>int buttonSequence[16];</code> .
Change the sound effects	Try changing the sequence of notes that play when you start, win or lose the game.
2-Player mode	Ready for a real coding challenge? Try changing the code so that two players can play head-to-head.

Troubleshooting

Problem	Solution
---------	----------

One of the LEDs isn't lighting up	Make sure your LED is flipped around in the right direction. If the LED still doesn't work, try wiggling the resistor and the wires that connect to the LED.
The buzzer is too loud or too quiet	Turn the potentiometer to adjust the volume
One of the buttons isn't working	Carefully check your wiring for each button. One leg of the button should connect to a pin on the RedBoard; the other leg should connect to the ground rail on the breadboard.
None of the buttons or LEDs is working	Make sure you don't have 5V and GND mixed up. Double check that you have a GND connection from the RedBoard to the GND rail on the breadboard.
Still not working?	Jumper wires unfortunately can go "bad" from getting bent too much. The copper wire inside can break, leaving an open connection in your circuit. If you are certain that your circuit is wired correctly and that your code is error-free and uploaded, but you are still encountering issues, try replacing one or more of the jumper wires for the component that is not working.

Project 3: Motion

Tired of your cat walking all over the kitchen counter? How about the dog getting into the garbage? Need a way to stop your little brother from sneaking into your bedroom? Learn how to protect against all of these annoyances as you build a multipurpose alarm. The alarm detects distance and motion using an ultrasonic distance sensor, and creates motion using a servo motor.

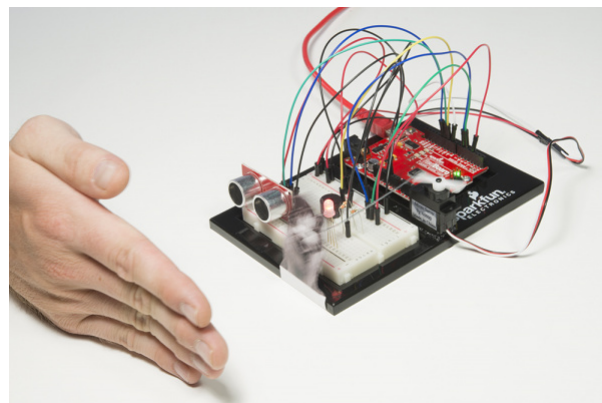

New Components Introduced in This Project

Each of the components listed below will be described in more detail as you progress through each circuit.

- Servo Motor
- Ultrasonic Distance Sensor

New Concepts Introduced in This Project

Each of the concepts listed below will be described in more detail as you progress through each circuit.

- PWM Duty Cycle
- Arduino Libraries
- Objects and Methods
- Datasheets
- Digital Sensors
- Servo Mechanisms

You Will Learn

- How to control a servo motor
- How to use an ultrasonic distance sensor
- How to move objects using servo mechanisms

Circuit 3A: Servo Motors

In this circuit, you will learn how to wire a servo and control it with code. Servo motors can be told to move to a specific position and stay there. Low-cost servo motors were originally used to steer remote-controlled airplanes and cars, but they have become popular for any project where precise movement is needed.

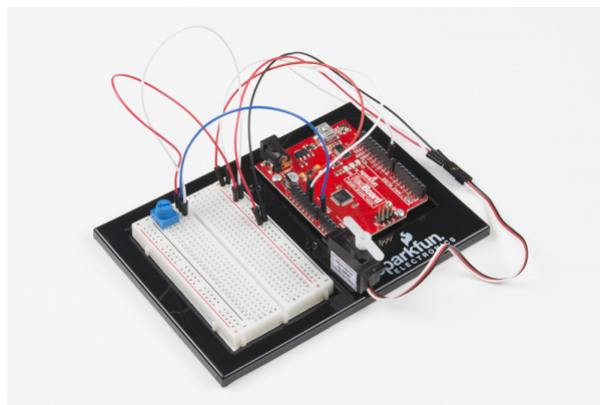

Parts Needed

Grab the following quantities of each part listed to build this circuit:



Additional Materials

- Scissors (NOT INCLUDED)

New Components

Servo Motors

Regular DC motors have two wires. When you hook the wires up to power, the motor spins around and around. Servo motors, on the other hand, have three wires: one for power, one for ground and one for signal. When you send the right signal through the signal wire, the servo will move to a specific angle and stay there. Common servos rotate over a range of 0° to 180°. The signal that is sent is a PWM signal, the same used to control the RGB LED in Project 1.

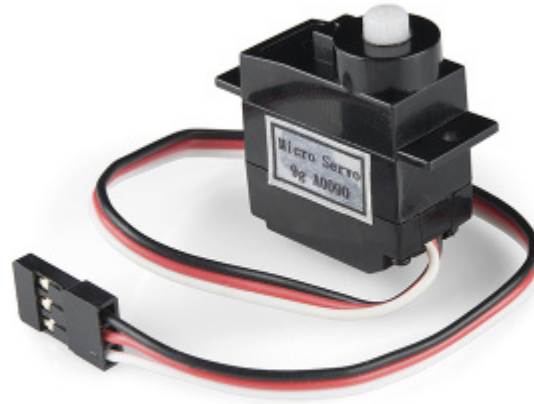

New Concepts

Duty Cycle

The Pulse Width Modulation (PWM) hardware available on a microcontroller is a great way to generate servo control signals. When talking about how long a PWM signal is on, this is referred to as duty cycle. Duty cycle is measured in percentage. The percentage of duty cycle specifically describes the percentage of time a digital signal is on over an interval or period of time. The variation in the duty cycle tells the servo which position to go to in its rotation.

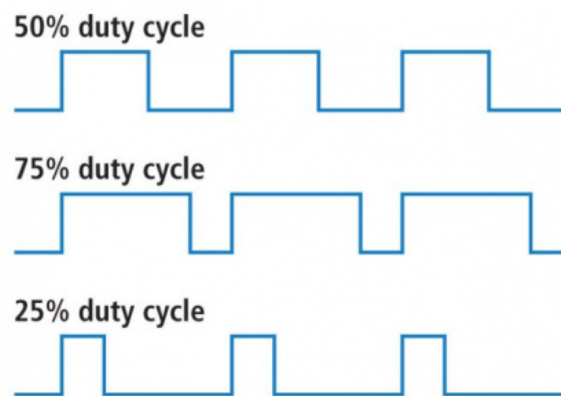

50%, 75% and 25% duty cycle examples

Arduino Libraries

Writing code that sends precise PWM signals to the servo would be time consuming and would require a lot more knowledge about the servo. Luckily, the Arduino IDE has hundreds of built-in and user-submitted containers of code that are called libraries. One of the built-in libraries, the Servo Library, allows us to control a servo with just a few lines of code!

To use one of the built-in Arduino libraries, all you have to do is “include” a link to its header file. A header file is a smaller code file that contains definitions for all the functions used in that library. By adding a link to the header file in your code, you are enabling your code to use all of those library functions. To use the Servo Library, you would add the following line to the top of your sketch.

```
#include <Servo.h>
```

Objects and Methods

To use the Servo Library, you will have to start by creating a servo object, like this:

```
Servo myServo;
```

Objects look a lot like variables, but they can do much more. Objects can store values, and they can have their own functions, which are called methods.

The most used method that a servo object has is `.write()` .

```
myServo.write(90);
```

The write method takes one parameter, a number from 0 to 180, and moves the servo arm to the specified position (in this case, degree 90).

Why would we want to go to the trouble of making an object and a method instead of just sending a servo control signal directly over a pin? First, the servo object does the work of translating our desired position into a signal that the servo can read. Second, using objects makes it easy for us to add and control more than one servo.

Hardware Hookup

Polarized
Components



Pay special attention to the component’s markings indicating how to place it on the breadboard. Polarized components can only be connected to a circuit in one direction.

Servo motor connectors are polarized, but there is no place to attach them directly. Instead, connect three jumper wires to the female 3-pin header on the servo. This will make it so you can connect the servo to the breadboard.

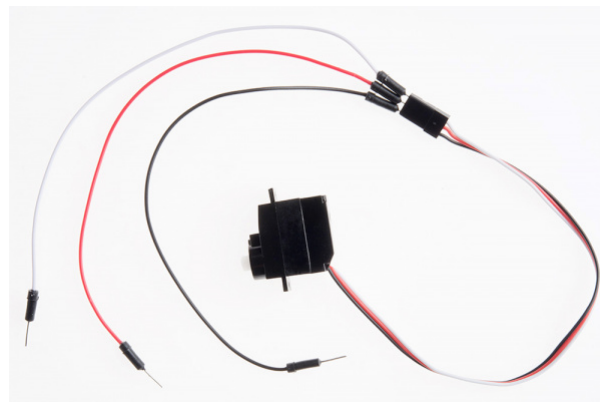

The servo wires are color coded to make hookup simple. The pin-out is as follows:

Pin	Description
-----	-------------

White	Signal - PWM In
Red	Power (5V)
Black	Ground (GND)

Included with your servo motor you will find a variety of motor mounts that connect to the shaft of your servo. You may choose to attach any mount you wish for this circuit. It will serve as a visual aid, making it easier to see the servo spin. The mounts will also come in handy at the end of this project.



The various motor mounts included with your servo motor

Affix the Servo (optional)

Included in your SIK is a strip of Dual Lock™. Cut a piece off the strip that is about $\frac{5}{8}$ inch or 1.6cm. Then cut that strip in half to get two pieces that are roughly $\frac{5}{8}$ inch x $\frac{1}{2}$ inch or 1.6cm x 1.3cm.



Peel off the adhesive backing, and stick one half on the bottom of the servo motor.

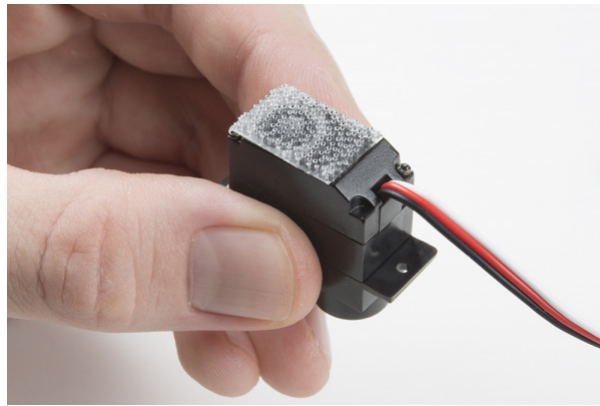

Stick the other half anywhere on the breadboard baseplate you want. Firmly press the bottom of the servo to the baseplate to temporarily adhere the two pieces of Dual Lock together. This will help stabilize the servo motor as it moves about.

Ready to start hooking everything up? Check out the Fritzing diagram below to see how everything is connected.

Circuit Diagram

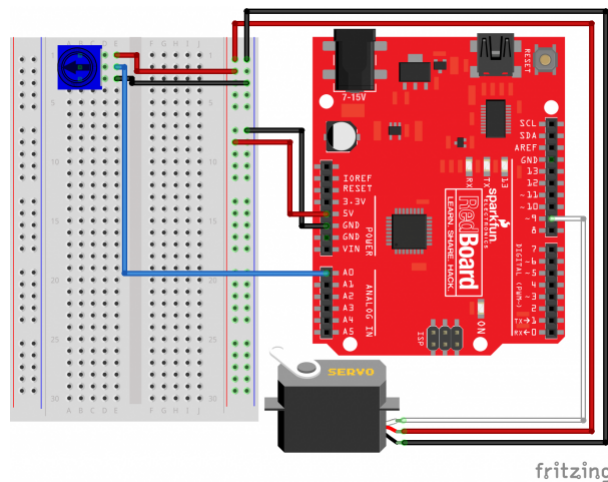

Having a hard time seeing the circuit? Click on the image for a closer look.

Hookup Table

Component	RedBoard	Breadboard	Breadboard	Breadboard	Servo 
Potentiometer		B1	B2	B3	
Jumper Wire	Analog Pin 0	E2			
Jumper Wire		E1	5V Rail (+)		
Jumper Wire		E3	GND Rail (-)		
Jumper Wire	5V	5V Rail (+)			
Jumper Wire	GND	GND Rail (-)			
Jumper Wire	Digital Pin 9				White Servo Pin
Jumper Wire				5V Rail (+)	Red Servo Pin

Jumper Wire				GND Rail (-)	Black Servo Pin
-------------	--	--	--	----------------	-----------------

*In the table, polarized components are shown with a warning triangle and the **whole column** highlighted **yellow**.*

Open the Sketch

To open the code, go to: **File > Examples > SIK_Guide_Code-V_4 > SIK_Circuit_3A-Servo**.

You can also copy and paste the following code into the Arduino IDE. Hit upload, and see what happens!

```

/*
SparkFun Inventor's Kit
Circuit 3A-Servo

Move a servo attached to pin 9 so that it's angle matches a potentiometer attached to A0.

This sketch was written by SparkFun Electronics, with lots of help from the Arduino community.
This code is completely free for any use.

View circuit diagram and instructions at: https://learn.sparkfun.com/tutorials/sparkfun-inventor-s-kit-experiment-guide---v40
Download drawings and code at: https://github.com/sparkfun/SIK-Guide-Code
*/

#include <Servo.h>           //include the servo library

int potPosition;           //this variable will store the position of the potentiometer
int servoPosition;        //the servo will move to this position

Servo myservo;            //create a servo object

void setup() {

  myservo.attach(9);       //tell the servo object that its servo is plugged into pin 9
}

void loop() {

  potPosition = analogRead(A0);           //use analog read to measure the position of
  the potentiometer (0-1023)

  servoPosition = map(potPosition, 0,1023,20,160); //convert the potentiometer number to a servo
  position from 20-160

  //Note: its best to avoid driving the little
  SIK servos all the                               //way to 0 or 180 degrees it can cause the m
  otor to jitter, which is bad for the servo.

  myservo.write(servoPosition);           //move the servo to the 10 degree position
}

```

What You Should See

Turning the potentiometer will cause the servo to turn.

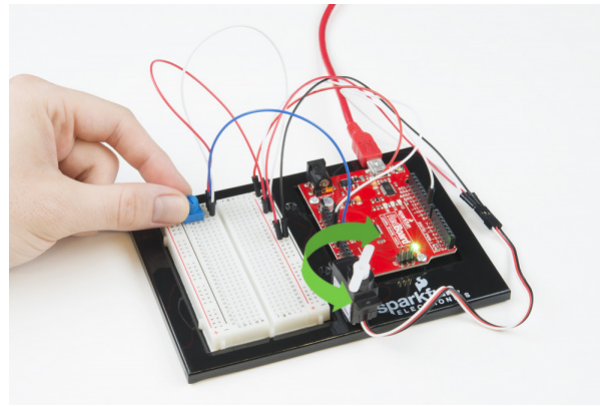

Program Overview

1. Read the value of the potentiometer.
2. Convert the potentiometer value (0–1023) to an angle (20–160).
3. Tell the servo to go to this angle.

Code to Note

Code	Description
Including Libraries: <code>#include <Servo.h></code>	The <code>#include</code> command adds a library to your Arduino program. After you include a library, you can use the commands in the library in your program. This line adds the Servo library.
Creating Servo Objects: <code>Servo myServo;</code>	The <code>Servo</code> command creates a new servo object and assigns a name to it, <code>myServo</code> in this case. If you make more than one servo object, you will need to give them different names.
Servo Attach: <code>myServo.attach(9);</code>	The <code>.attach()</code> method tells the servo object to which pin the signal wire of its servo is attached. It will send position signals to this pin. In this sketch, pin 9 is used. Remember to only use digital pins that are capable of PWM.
Range Mapping: <code>map(potPosition, 0,1023,20,160);</code>	As shown in previous circuits, the analog pin values on your microcontroller vary from 0-1023. However, what if we want those values to control a servo motor that only accepts a value from 0-180? The answer is to use the <code>map</code> function. The <code>map()</code> function takes a range of values and outputs a different range of values that can contain more or less values than the original. In this case, we are taking the range 0-1023 and mapping it to the range 20-160.
Servo Write: <code>myServo.write(90);</code>	The <code>.write()</code> method moves the servo to a specified angle. In this example, the servo is being told to go to angle 90.

Coding Challenges

Challenge	Description

Reverse the direction	Try making the servo move in the opposite direction to the potentiometer.
Change the range	Try altering the map function so that moving the potentiometer a lot only moves the servo a little.
Swap in a different sensor	Try swapping a light sensor in for the potentiometer. You have just made a dial that reads how much light is present!

Troubleshooting

Problem	Solution
The servo doesn't move	Check the wiring on your servo. Make sure that the red wire on the servo cord is connected to 5V, the black wire is connected to GND and the white signal wire is connected to pin 9.
The servo is twitching	Although these servos are supposed to move from 0 to 180 degrees, sometimes sending them to the extremes of their range causes them to twitch (the servo is trying to move farther than it can). Make sure that you aren't telling the servo to move outside of the 20-160 degree range.

Circuit 3B: Distance Sensor

Distance sensors are amazing tools with all kinds of uses. They can sense the presence of an object, they can be used in experiments to calculate speed and acceleration, and they can be used in robotics to avoid obstacles. This circuit will walk you through the basics of using an ultrasonic distance sensor, which measures distance using sound waves!

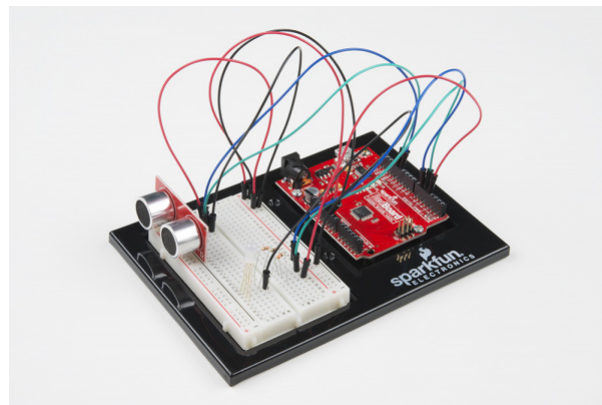

Parts Needed

Grab the following quantities of each part listed to build this circuit:



Need Ultrasonic Distance Sensor image for parts list

New Components

Ultrasonic Distance Sensor

Distance sensors work by sending pulses of light or sound out from a transmitter, then timing how long it takes for the signals to bounce off an object and return to a receiver (just like sonar). Some sensors use infrared light, some use lasers, and some, like the HC-SR04 included in your kit, use ultrasonic sound (sound so high-pitched that you can't hear it).

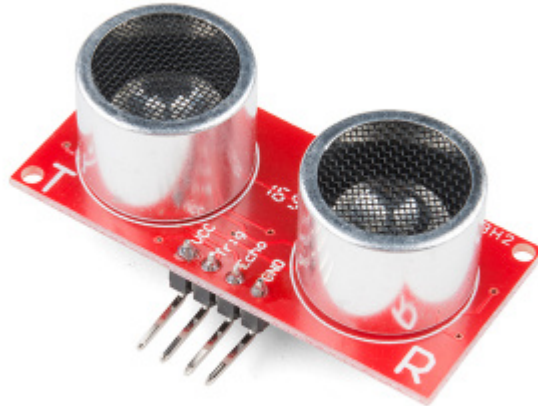

New Concepts

Datasheets

When working with electronics, datasheets are your best friend. Datasheets contain all the relevant information needed to get you up and running with a part. In this circuit, we are calculating distance based on the time it takes sound waves to be transmitted, bounce off an object and then be received. But, how can we tell distance from that information? The answer lies in the datasheet for the distance sensor. In it, you can find the equation the program needs to interpret distance from the time it takes the sound wave to travel.

Else If Statement

In the night-light circuit, you used an **if/else** statement to run one set of code when a logic statement was true, and a different set of code when it was false. What if you wanted to have more than two options? **Else if** statements let you run as many logical tests as you want in one **if** statement. For example, in the code for this circuit, there is an **if** statement that flows like this:

1. **If** the distance is less than 10, make the RGB LED red.
2. **Else if** the distance is more than 10 but less than 20, make the RGB LED yellow.
3. **Else** make the RGB LED green.

If you wanted to have four or five colors for different distances, you could add more **else if** statements.

Else if statements are different from nested **if** statements in that only one of the statements above can be true, whereas you could have multiple nested **if** statements that could true.

Hardware Hookup

Polarized Components 	Pay special attention to the component's markings indicating how to place it on the breadboard. Polarized components can only be connected to a circuit in one direction.
---	---

The distance sensor is polarized. Take note of the pin labels when connecting your circuit.

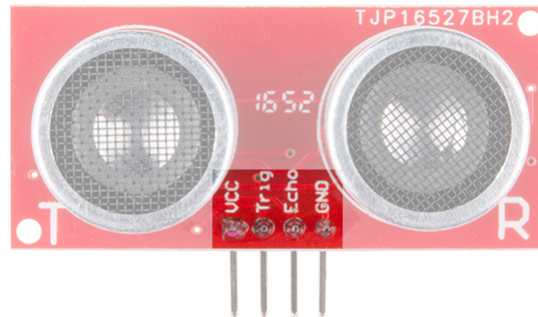

The following table describes the function of each pin on the distance sensor:

Pin	Description
VCC	Power (5V)
Trig	Trigger Pulse Input: Sends bursts of ultrasound at 40kHz.
Echo	Echo Pulse Output: Receives echo signal. Range is calculated by the proportion of trigger signal sent and echo signal received.
GND	Ground (0V)

Ready to start hooking everything up? Check out the Fritzing diagram below to see how everything is connected.

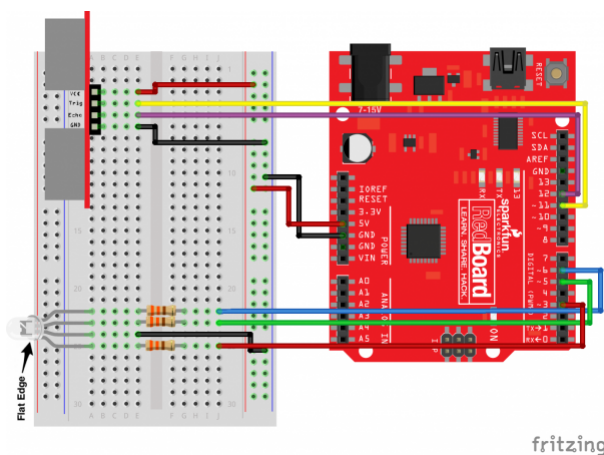

Circuit Diagram



Having a hard time seeing the circuit? Click on the image for a closer look.

Hookup Table

Component	RedBoard	Breadboard	Breadboard	Breadboard	Breadboard

Jumper Wire	5V	5V Rail (+)			
Jumper Wire	GND	GND Rail (-)			
RGB LED 		A25 (RED)	A24 (GND)	A23 (GREEN)	A22 (BLUE)
330Ω Resistor (orange, orange, brown)		E22	F22		
330Ω Resistor (orange, orange, brown)		E23	F23		
330Ω Resistor (orange, orange, brown)		E25	F25		
Jumper Wire		E24	GND Rail (-)		
Jumper Wire	Digital Pin 3	J25			
Jumper Wire	Digital Pin 5	J23			
Jumper Wire	Digital Pin 6	J22			
Distance Sensor 		A3 (Vcc)	A4 (Trig)	A5 (Echo)	A6 (GND)
Jumper Wire	Digital Pin 11	E4 (Trig)			
Jumper Wire	Digital Pin 12	E5 (Echo)			
Jumper Wire		E3	5V Rail (+)		
Jumper Wire		E6	GND Rail (-)		

*In the table, polarized components are shown with a warning triangle and the **whole row highlighted yellow**.*

Open the Sketch

To open the code, go to: **File > Examples > SIK_Guide_Code-V_4 > SIK_Circuit_3B-DistanceSensor**

You can also copy and paste the following code into the Arduino IDE. Hit upload, and see what happens!

```

/*
SparkFun Inventor's Kit
Circuit 3B-Distance Sensor

Control the color of an RGB LED using an ultrasonic distance sensor.

This sketch was written by SparkFun Electronics, with lots of help from the Arduino community.
This code is completely free for any use.

View circuit diagram and instructions at: https://learn.sparkfun.com/tutorials/sparkfun-inventor-s-kit-experiment-guide---v40
Download drawings and code at: https://github.com/sparkfun/SIK-Guide-Code
*/

const int trigPin = 11;           //connects to the echo pin on the distance sensor
const int echoPin = 12;          //connects to the trigger pin on the distance sensor

const int redPin = 3;            //pin to control the red LED inside the RGB LED
const int greenPin = 5;          //pin to control the green LED inside the RGB LED
const int bluePin = 6;           //pin to control the blue LED inside the RGB LED

float distance = 0;              //stores the distance measured by the distance sensor

void setup()
{
  Serial.begin (9600);           //set up a serial connection with the computer

  pinMode(trigPin, OUTPUT);      //the trigger pin will output pulses of electricity
  pinMode(echoPin, INPUT);       //the echo pin will measure the duration of pulses coming back from the distance sensor

  //set the RGB LED pins to output
  pinMode(redPin, OUTPUT);
  pinMode(greenPin, OUTPUT);
  pinMode(bluePin, OUTPUT);
}

void loop() {
  distance = getDistance();      //variable to store the distance measured by the sensor

  Serial.print(distance);        //print the distance that was measured
  Serial.println(" in");        //print units after the distance

  if(distance <= 10){           //if the object is close

    //make the RGB LED red
    analogWrite(redPin, 255);
    analogWrite(greenPin, 0);
    analogWrite(bluePin, 0);

  } else if(10 < distance && distance < 20){ //if the object is a medium distance

    //make the RGB LED yellow
    analogWrite(redPin, 255);

```

```

    analogWrite(redPin, 255);
    analogWrite(greenPin, 50);
    analogWrite(bluePin, 0);

} else{                                     //if the object is far away

    //make the RGB LED green
    analogWrite(redPin, 0);
    analogWrite(greenPin, 255);
    analogWrite(bluePin, 0);
}

delay(50);      //delay 50ms between each reading
}

//-----FUNCTIONS-----

//RETURNS THE DISTANCE MEASURED BY THE HC-SR04 DISTANCE SENSOR
float getDistance()
{
    float echoTime;                //variable to store the time it takes for a ping to bounce off an object
    float calculatedDistance;      //variable to store the distance calculated from the echo time

    //send out an ultrasonic pulse that's 10ms long
    digitalWrite(trigPin, HIGH);
    delayMicroseconds(10);
    digitalWrite(trigPin, LOW);

    echoTime = pulseIn(echoPin, HIGH); //use the pulseIn command to see how long it takes for the
                                        //pulse to bounce back to the sensor

    calculatedDistance = echoTime / 148.0; //calculate the distance of the object that reflected the pulse (half the bounce time multiplied by the speed of sound)

    return calculatedDistance;        //send back the distance that was calculated
}

```

What You Should See

Move your hand or a large, flat object closer and farther away from the distance sensor. As the object approaches, the light will change from green to yellow to red.

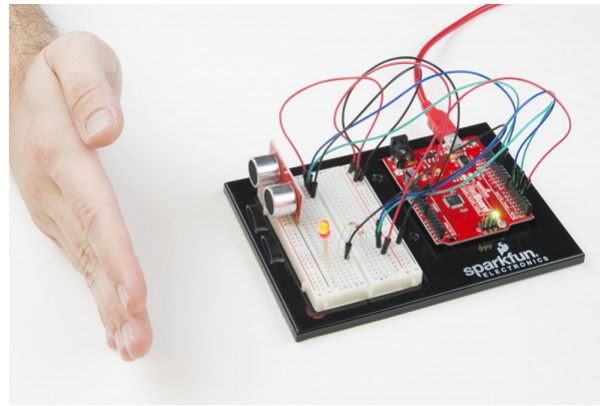

Open the Serial Monitor, and you should see the distance printed to the window.

Troubleshooting Warning: HVAC systems in offices and schools have been known to interfere with the performance of the ultrasonic distance sensor. If you are experiencing sporadic behavior from your circuit, check your surroundings. If there are numerous air ducts in the room you are using, try moving to a different room that does not have ducts. The airflow from these ducts can interfere with the waves sent from the sensor, creating noise and resulting in bad readings.

Program Overview

1. Check what distance the sensor is reading.
 - a. If the distance is less than 10 inches, make the RGB LED red.
 - b. If the distance is between 10 and 20 inches, make the RGB LED yellow.
 - c. If the distance value is not equal to the first two conditions, make the RGB LED green.

Code to Note

Code	Description
Float Variables: <pre>float echoTime;</pre>	The float variable, short for floating-point number, is similar to an integer except it can represent numbers that contain a decimal point. Floats are good for representing values that need to be more precise than an int. Floats allow us to measure precise distances such as 9.33 inches instead of just 9 inches.
Else if Statement: <pre>if(logic statement){ code to run if logic statement is true } else if(second logic statement){ code to run if the second logic statement is true } else(default logic statement){ code to run if neither of the first two statements are true }</pre>	Else if statements let you combine more than one logic statement. Arduino will test each logic statement in order; if one is true it will run the code in that section and then skip all of the other sections of code in the if statement.

User-Defined Function: <code>getDistance();</code>	This function tells the distance sensor to send out an ultrasonic wave form, measures the time it takes to bounce back to the sensor, then calculates the distance based on the speed of sound. This calculation is based off information found in the distance sensor's datasheet.
--	---

Coding Challenges

Challenge	Description
Change the limits of the distance sensor	Try editing the values in the logic statements so that the RGB LED changes color at different distances.
Change the units of the distance sensor	Try editing the code so that the distance sensor outputs a different unit of length, such as centimeters or feet.
Add a fourth color	Try adding another else if statement so that there are four different colors instead of three.

Troubleshooting

Problem	Solution
The RGB LED colors aren't working or a color is missing	Check the connection for the wire and resistor connected to each leg of the LED. Ensure the RGB LED is inserted in the correct orientation.
The distance sensor doesn't seem to work	Open up the serial monitor on your computer. You should see a stream of distances being printed in the monitor. If they are all reading 0 or jump around, then check the wiring on your sensor.
The distance sensor still doesn't work	Ultrasonic noise pollution will interfere with your distance sensor readings. If you aim two distance sensors at each other, they will confuse each other. Some air-conditioning systems may also emit noises in the ultrasonic range. Try pointing your sensor away from the other distance sensors or changing to a different location.

Circuit 3C: Motion Alarm

Time to take your distance sensor project to the next level. Let's imagine that you want to stop your cat from prowling around your countertop. This circuit will use light, sound and motion to scare away your cat when it is detected by the distance sensor. Using a servo motor, you can add a moving pop-up to animate your alarm.

Don't have a cat? No problem! This circuit can be adapted for a variety of projects such as a room alarm, an automated pop-up story, an automatic treat dispenser and so much more. Let your imagination run wild with this project.

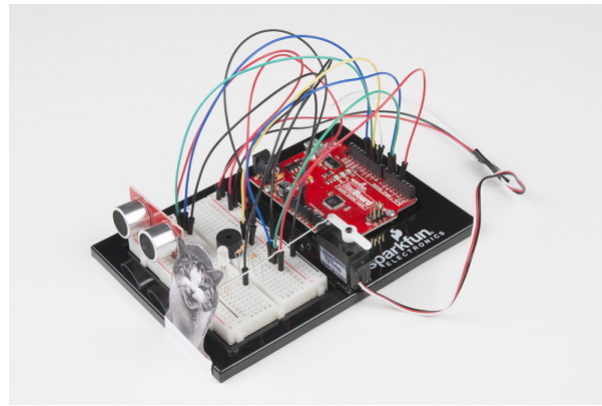

Parts Needed

Grab the following quantities of each part listed to build this circuit:



Need Ultrasonic Distance Sensor image for parts list

Additional Materials (NOT INCLUDED)

The following materials are optional. The circuit can be completed without these items.

- Paper
- Scissors
- Scotch™ Tape
- Markers/Pen
- Paper Clip
- Needle-Nose Pliers

New Concepts

Getting Creative With Mechanisms

This circuit gets really fun when you start to use your servo to animate the world around you. To do this, you'll need to connect your servo to some physical mechanisms. Tape and hot glue are easy ways to connect things to your servo. You can also loop a paper clip through the small holes in the servo arm to serve as a linkage. See the Hardware Hookup section below for more information.



Linkage rods are found on many RC airplanes, which use servo motors to control the ailerons, elevators and rudder.

Hardware Hookup

If you have opted for the extra materials, use the following instructions to create the moving pop-up for your cat alarm.

To begin, attach your servo to the baseplate using Dual Lock, as described in Circuit 3A.

Attach the servo mount of your choice. It is recommended you wait until after you have uploaded your code to ensure the mount is in the best position before screwing on the mount. The screw is optional, but it will make for a more robust mechanism.



Next, use needle-nose pliers to bend the paper clip straight. Imagine a 3D space. The straight clip is the X-axis. Bend one end of the paper clip 90 degrees along the Y-axis. The bent segment should be about 1 inch or 2.5cm long. Then bend the other end along the Z-axis. This bend should be about 1/8 inch or 3mm long. Repeat this bend once more back toward the X-axis, making a hook shape. You should now have a linkage rod that looks something like this:



Attach the hook end of the linkage rod to the end hole on your servo mount.

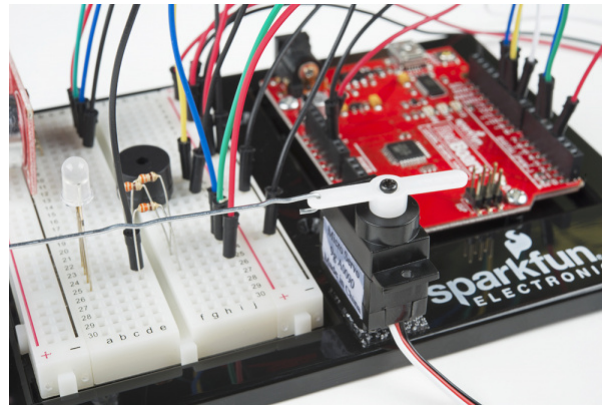

Cut out the pop-up image of your choice. We chose this public domain menacing cat image (<http://bit.ly/2vinyE1>). The image you choose should be about 2.5 inches x 2.5 inches and can be drawn or printed. Leave a rectangular strip of paper under the image that is about 2 inches long. Fold along the bottom of the image. Tape the pop-up to the underside of the breadboard baseplate on the same side to which the servo is connected.

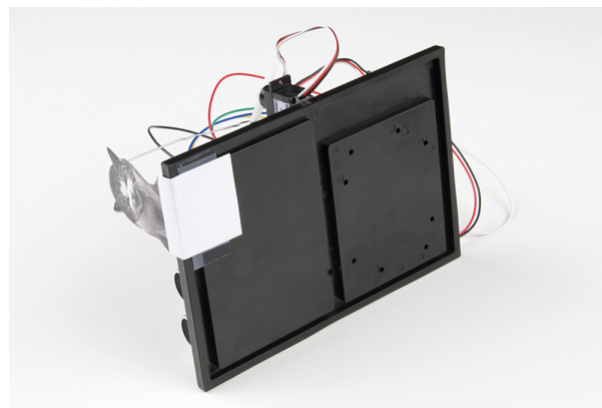

Last, tape the free end of the rod to the back of your pop-up image.

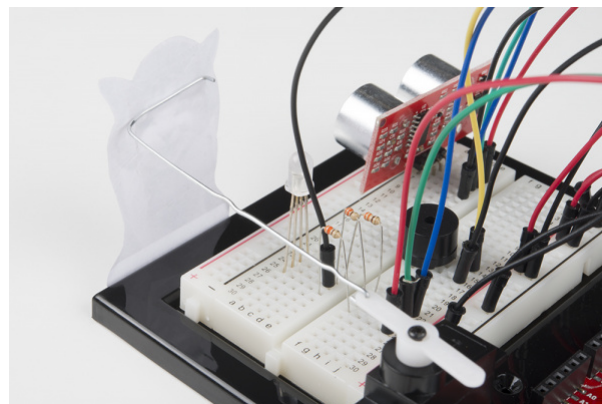

Once you have the rest of the circuit built and the code uploaded, you can fine-tune your moving pop-up and make any necessary adjustments. Remember to wait until these adjustments have been made before you screw the servo mount onto the motor.

Ready to start hooking everything up? Check out the Fritzing diagram below to see how everything is connected.

Circuit Diagram

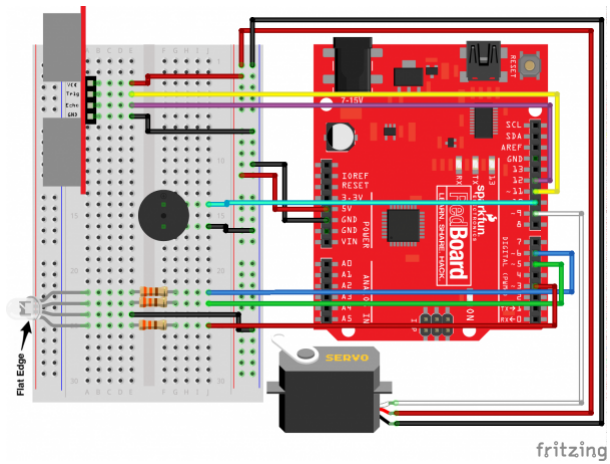

Having a hard time seeing the circuit? [Click on the image for a closer look.](#)

Hookup Table

Component	RedBoard	Breadboard	Breadboard	Breadboard	Breadboard	Se
Jumper Wire	5V	5V Rail (+)				
Jumper Wire	GND	GND Rail (-)				
RGB LED ⚠		A25 (RED)	A24 (GND)	A23 (GREEN)	A22 (BLUE)	
330Ω Resistor (orange, orange, brown)		E22	F22			
330Ω Resistor (orange, orange, brown)		E23	F23			
330Ω Resistor (orange, orange, brown)		E25	F25			
Jumper Wire		E24	GND Rail (-)			
Jumper Wire	Digital Pin 3	J25				
Jumper Wire	Digital Pin 5	J23				
Jumper Wire	Digital Pin 6	J22				
Distance Sensor ⚠		A3 (Vcc)	A4 (Trig)	A5 (Echo)	A6 (GND)	
Jumper Wire	Digital Pin 11	E4 (Trig)				
Jumper Wire	Digital Pin 12	E5 (Echo)				
Jumper Wire		E3	5V Rail (+)			

Jumper Wire		E6	GND Rail (-)			
Buzzer⚠		F14 (Buzzer +)	F16 (Buzzer -)			
Jumper Wire	Digital Pin 10	J14				
Jumper Wire		J16	GND Rail (-)			
Jumper Wire	Digital Pin 9					White
Jumper Wire					5V Rail (+)	Red
Jumper Wire					GND Rail (-)	Black

*In the table, polarized components are shown with a warning triangle and the **whole row or whole column** highlighted **yellow**.*

Open the Sketch

To open the code, go to: **File > Examples > SIK_Guide_Code-V_4 > SIK_Circuit_3C-CatAlarm**

You can also copy and paste the following code into the Arduino IDE. Hit upload, and see what happens!

```

/*
SparkFun Inventor's Kit
Circuit 3C-Motion Alarm

Control the color of an RGB LED using an ultrasonic distance sensor. When an object is close to
the sensor, buzz the buzzer and wiggle the servo motor.

This sketch was written by SparkFun Electronics, with lots of help from the Arduino community.
This code is completely free for any use.

View circuit diagram and instructions at: https://learn.sparkfun.com/tutorials/sparkfun-inventor-s-kit-experiment-guide---v40
Download drawings and code at: https://github.com/sparkfun/SIK-Guide-Code
*/

#include <Servo.h>                //include the servo library

const int trigPin = 11;          //connects to the echo pin on the distance sensor
const int echoPin = 12;         //connects to the trigger pin on the distance sensor

const int redPin = 3;           //pin to control the red LED inside the RGB LED
const int greenPin = 5;        //pin to control the green LED inside the RGB LED
const int bluePin = 6;         //pin to control the blue LED inside the RGB LED

const int buzzerPin = 10;       //pin that will drive the buzzer

float distance = 0;             //stores the distance measured by the distance sensor

Servo myservo;                 //create a servo object

void setup()
{
  Serial.begin (9600);          //set up a serial connection with the computer

  pinMode(trigPin, OUTPUT);     //the trigger pin will output pulses of electricity
  pinMode(echoPin, INPUT);      //the echo pin will measure the duration of pulses coming back from the distance sensor

  //set the RGB LED pins to output
  pinMode(redPin, OUTPUT);
  pinMode(greenPin, OUTPUT);
  pinMode(bluePin, OUTPUT);

  pinMode(buzzerPin, OUTPUT);   //set the buzzer pin to output

  myservo.attach(9);            //use pin 9 to control the servo
}

void loop() {
  distance = getDistance();     //variable to store the distance measured by the sensor

  Serial.print(distance);       //print the distance that was measured

```



```

Serial.println(" in");      //print units after the distance

if(distance <= 10){        //if the object is close

    //make the RGB LED red
    analogWrite(redPin, 255);
    analogWrite(greenPin, 0);
    analogWrite(bluePin, 0);

    //this code wiggles the servo and beeps the buzzer
    tone(buzzerPin, 272);      //buzz the buzzer pin
    myservo.write(45);        //move the servo to 45 degrees
    delay(100);              //wait 100 milliseconds

    noTone(buzzerPin);        //turn the buzzer off
    myservo.write(135);       //move the servo to 135 degrees
    delay(100);              //wait 100 milliseconds

} else if(10 < distance && distance < 20){ //if the object is a medium distance

    //make the RGB LED yellow
    analogWrite(redPin, 255);
    analogWrite(greenPin, 50);
    analogWrite(bluePin, 0);

} else{                    //if the object is far away

    //make the RGB LED green
    analogWrite(redPin, 0);
    analogWrite(greenPin, 255);
    analogWrite(bluePin, 0);
}

delay(50);      //delay 50ms between each reading
}

//-----FUNCTIONS-----

//RETURNS THE DISTANCE MEASURED BY THE HC-SR04 DISTANCE SENSOR
float getDistance()
{
    float echoTime;          //variable to store the time it takes for a ping to bounce off an object
    float calculatedDistance; //variable to store the distance calculated from the echo time

    //send out an ultrasonic pulse that's 10ms long
    digitalWrite(trigPin, HIGH);
    delayMicroseconds(10);
    digitalWrite(trigPin, LOW);

    echoTime = pulseIn(echoPin, HIGH); //use the pulseIn command to see how long it takes for the

```

```
        //pulse to bounce back to the sensor

    calcualtedDistance = echoTime / 148.0; //calculate the distance of the object that reflected
    the pulse (half the bounce time multiplied by the speed of sound)

    return calcualtedDistance;           //send back the distance that was calculated
}
```

What You Should See

The RGB LED will behave as in your last circuit. It will be green when objects are far, yellow when they are midrange and red when they are close. When an object is close the buzzer will also beep, and the servo will rotate back and forth.

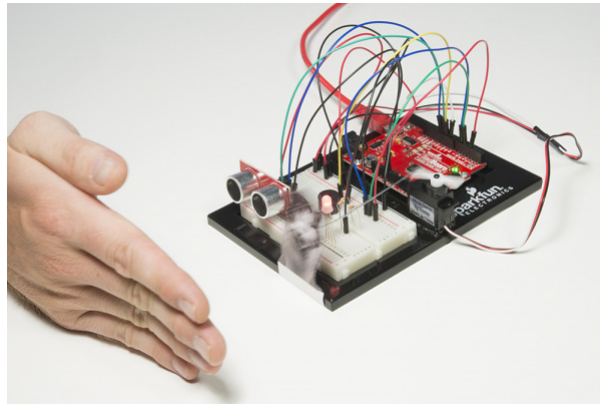

Troubleshooting Warning: HVAC systems in offices and schools have been known to interfere with the performance of the ultrasonic distance sensor. If you are experiencing sporadic behavior from your circuit, check your surroundings. If there are numerous air ducts in the room you are using, try moving to a different room that does not have ducts. The airflow from these ducts can interfere with the waves sent from the sensor, creating noise and resulting in bad readings.

Program Overview

1. Check what distance the sensor is reading.
 - a. If the distance is less than 10 inches, make the RGB LED red. Then make the servo rotate back and forth and make the buzzer beep.
 - b. If the distance is between 10 and 20 inches, make the RGB LED yellow.
 - c. If the distance value is not equal to the fist two conditions, make the RGB LED green.

Code to Note

Code	Description
Constants: const int trigPin = 11;	Constants are variables that have been marked as "read-only" and cannot have their value changed as the program progresses. Constants are great for declaring pin number variables that will not change throughout the program.

<p>No Tone Function:</p> <pre>noTone(pin_number);</pre>	<p>In circuit 2A you made songs using a buzzer and the tone function, but you gave the tone function three parameters: a pin number, a frequency and a duration. You can leave out the third parameter, and the tone will play until you change it or turn it off. <code>noTone()</code> turns off a pin that has been activated with the tone command.</p>
---	---

Coding Challenges

Challenge	Description
Change the servo behavior	Try changing the way that your servo behaves when the distance sensor is triggered.
Change the alarm settings	Try altering the code so the alarm goes off from much farther or closer distances.
Create a different mechanism	Try your hand at making different objects move with your servo motor. Make an interactive pop-up story. Make an automatic fish feeder. Time to use your imagination!

Troubleshooting

Problem	Solution
The RGB LED colors aren't working or a color is missing	Check the connection for the wire and resistor connected to each leg of the LED. Ensure the RGB LED is inserted in the correct orientation.
The distance sensor doesn't seem to work	Open up the Serial Monitor on your computer. You should see a stream of distances being printed in the monitor. If they are all reading 0 or jumping around, then check the wiring on your sensor.
The distance sensor still doesn't work	Ultrasonic noise pollution will interfere with your distance sensor readings. If you aim two distance sensors at each other, they will confuse each other. Some air conditioning systems may also emit noises in the ultrasonic range. Try pointing your sensor away from the other distance sensors or changing to a different location.
The servo doesn't work	Make sure all of your servo wires are connected. Be sure that the black wire is connected to the negative rail and the red wire is connected to the positive rail. Make sure you are using a digital pin that is capable of PWM.
The pop-up is moving too much or not enough	The two lines of code that pass angles to the servo motor are <code>myservo.write(45);</code> and <code>myservo.write(135);</code> . Try changing these angle values to fine-tune your mechanism.

Project 4: Display

Printing data to the Arduino Serial Monitor is a great way to see data from the RedBoard. But, what if you want to make your project mobile and see sensor values away from your computer? This project will show you how to do exactly that. You'll learn about liquid crystal displays (LCDs) and how to print things like sensor data and strings of words to the display.



New Components Introduced in This Project

Each of the components listed below will be described in more detail as you progress through each circuit.

- Liquid Crystal Display (LCD)
- TMP36 Digital Temperature Sensor
- 4xAA Battery Holder

New Concepts Introduced in This Project

Each of the concepts listed below will be described in more detail as you progress through each circuit.

- Contrast
- Pixels
- Algorithms
- Button Debouncing
- Strings
- Pointers

You Will Learn

- How to print simple messages to an LCD
- How to use a temperature sensor
- How to print sensor data to an LCD
- How to make an interactive game that incorporates the LCD

Circuit 4A: LCD "Hello, World!"

Printing "Hello, world!" is usually the first thing that programming tutorials will have you do in a new language. This guide starts by blinking an LED, but now we're going to print out real text using a Liquid Crystal Display (LCD).

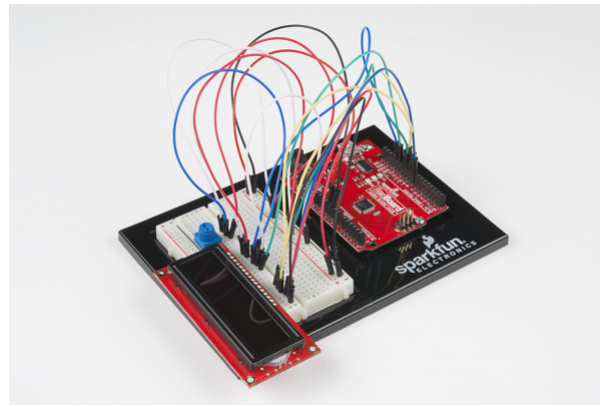

Parts Needed

Grab the following quantities of each part listed to build this circuit:



New Components

Character Liquid Crystal Display (LCD)

Character LCDs are designed to show a grid of letters, numbers and a few special characters. This makes them great for printing data and showing values. When current is applied to this special kind of crystal, it turns opaque. This is used in a lot of calculators, watches and simple displays. Adding an LCD to your project will make it super portable and allow you to integrate up to 32 characters (16 x 2) of information.

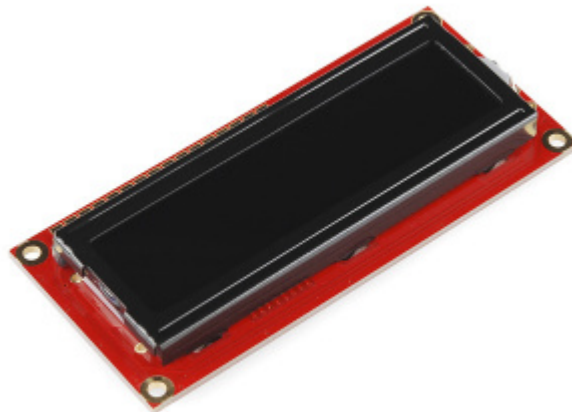

New Concepts

Contrast

Pin 3 on the LCD controls the contrast and brightness of the LCD. Using a simple voltage divider with a potentiometer, the contrast can be adjusted. As you rotate the knob on the potentiometer, you should notice that the screen will get brighter or darker and that the characters become more visible or less visible. The contrast of LCDs is highly dependent on factors such as temperature and the voltage used to power it. Thus, external contrast knobs are needed for displays that cannot automatically account for temperature and voltage changes.

Pixels

If you look closely at the characters on the LCD, you will notice that they are actually made up of lots of little squares. These little squares are called pixels. The size of displays is often represented in pixels. Pixels make up character space, which is the number of pixels in which a character can exist.

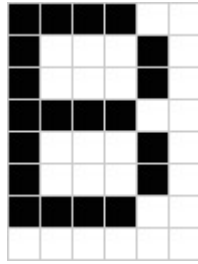

Here is a capital letter B as created in pixels. The character space in this example is 6 pixels x 8 pixels.

Hardware Hookup

<p>Polarized Components</p> 	<p>Pay special attention to the component's markings indicating how to place it on the breadboard. Polarized components can only be connected to a circuit in one direction.</p>
---	--

The LCD has 16 pins, and it is polarized. The pins are numbered from left to right, 1 through 16. The LCD utilizes an extremely common parallel interface LCD driver chip from Hitachi called the HD44780. Thankfully, the Arduino community has developed a library to handle a great deal of the software-to-hardware interface. Below is a list of each of the pins on the LCD.

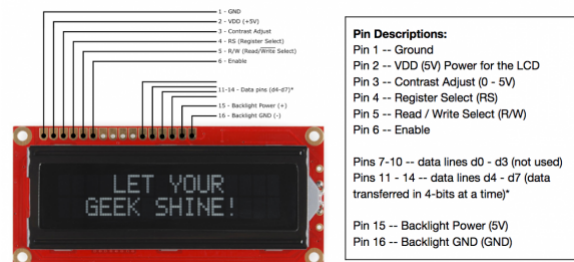

Click on the image for a closer look.

Ready to start hooking everything up? Check out the circuit diagram and hookup table below to see how everything is connected.

Circuit Diagram

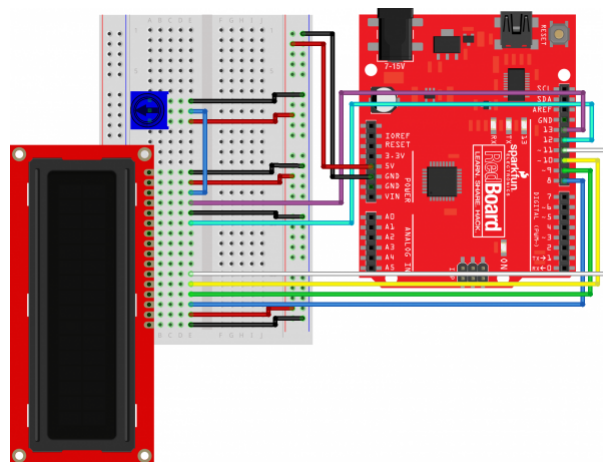

Having a hard time seeing the circuit? Click on the image for a closer look.

Hookup Table

Component	RedBoard	Breadboard	Breadboard	Breadboard
Jumper Wire	5V	5V Rail (+)		
Jumper Wire	GND	GND Rail (-)		
LCD ⚠		A15-A30 (Pin 1 on A15)		
Jumper Wire		E30	GND Rail (-)	
Jumper Wire		E29	5V Rail (+)	
Jumper Wire	Digital Pin 8	E28		
Jumper Wire	Digital Pin 9	E27		
Jumper Wire	Digital Pin 10	E26		
Jumper Wire	Digital Pin 11	E25		
Jumper Wire	Digital Pin 12	E20		
Jumper Wire		E19	GND Rail (-)	
Jumper Wire	Digital Pin 13	E18		
Jumper Wire		E16	5V Rail (+)	
Jumper Wire		E15	GND Rail (-)	
Potentiometer		A8	A9	A10
Jumper Wire		E9	E17	
Jumper Wire		E8	GND Rail (-)	
Jumper Wire		E10	5V Rail (+)	

In the table, polarized components are shown with a warning triangle and the **whole row highlighted yellow**.

Open the Sketch

To open the code, go to: **File > Examples > SIK_Guide_Code-V_4 > SIK_Circuit_4A-LCDHelloWorld**

You can also copy and paste the following code into the Arduino IDE. Hit upload, and see what happens!

```

/*
SparkFun Inventor's Kit
Circuit 4A-HelloWorld

The LCD will display the words "Hello World" and show how many seconds have passed since
the RedBoard was last reset.

This sketch was written by SparkFun Electronics, with lots of help from the Arduino community.
This code is completely free for any use.

View circuit diagram and instructions at: https://learn.sparkfun.com/tutorials/sparkfun-inventor-s-kit-experiment-guide---v40
Download drawings and code at: https://github.com/sparkfun/SIK-Guide-Code
*/

#include <LiquidCrystal.h>           //the liquid crystal library contains commands for printing
to the display

LiquidCrystal lcd(13, 12, 11, 10, 9, 8); // tell the RedBoard what pins are connected to the d
isplay

void setup() {

  lcd.begin(16, 2);                 //tell the lcd library that we are using a display that is 1
6 characters wide and 2 characters high
  lcd.clear();                       //clear the display
}

void loop() {

  lcd.setCursor(0,0);                //set the cursor to the 0,0 position (top left corner)
  lcd.print("Hello, world!");        //print hello, world! starting at that position

  lcd.setCursor(0,1);                //move the cursor to the first space of the bottom row
  lcd.print(millis()/1000);          //print the number of seconds that have passed since the las
t reset
}

```

What You Should See

The LCD screen will show "Hello, world!" On the row below, a counter will count every second that passes.

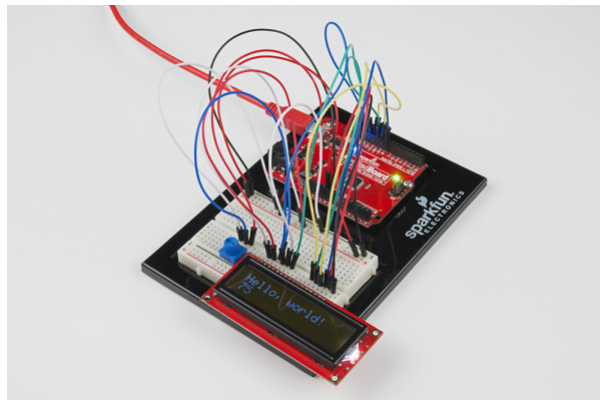

Contrast Adjust

If you are not seeing any characters, are seeing barely visible characters, or see just white rectangles, then you need to adjust the contrast. Twist the potentiometer very slowly until you can clearly read the display. If you reach the end of the potentiometer's rotation, try twisting in the opposite direction.

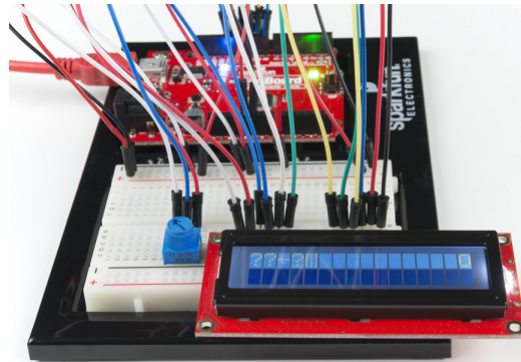

A display that needs the contrast adjusted. Note the white rectangles.

Program Overview

1. Import the LCD library.
2. Make an LCD object called "lcd" that will be controlled using pins 8, 9, 10, 11, 12 and 13.
3. "Begin" the LCD. This sets the dimensions of the LCD that you are working with (16 x 2). It needs to be called before any other commands from the LCD library are used.
4. Clear the display.
5. Set the cursor to the top left corner `lcd.setCursor(0,0);` , then print "Hello, world!"
6. Move the cursor to the first space of the lower line `lcd.setCursor(0,1);` , then print the number of seconds that have passed since the RedBoard was last reset.

Code to Note

Code	Description
LCD Library: <code>#include <LiquidCrystal.h></code>	Includes the liquid crystal library into your program.
LCD Library Instance: <code>LiquidCrystal LCD_name(RS_pin, enable_pin, d4, d5, d6, d7);</code>	As with servos, you need to create an LCD object and give it a name (you can make more than one). The numbers in the brackets are pins on the RedBoard that connect to specific pins on the LCD.
LCD Begin: <code>lcd.begin(16, 2);</code>	This line initializes the LCD object and tells the program the LCD's dimensions. In this case it is 16 characters by 2 characters.
LCD Clear: <code>lcd.clear();</code>	This method clears the pixels on the display.

LCD Cursor: <code>lcd.setCursor(0,0);</code>	Move the cursor to a point on the 16x2 grid of characters. Text that you write to the LCD will start from the cursor. This line is starting back at position (0,0).
LCD Print : <code>lcd.print("Hello, world!");</code>	Prints a string of characters to the LCD starting at the cursor position.

Coding Challenges

Challenge	Description
Change the message	Try changing the code to display another message.
Show hours, minutes and seconds	Try adding some code so that the display shows the hours, minutes and seconds that have passed since the RedBoard was last reset.
Count button presses	By adding a button to the circuit, you can count the number of times the button was pressed or have the button change what the LCD is displaying. There could be many pages of information.

Troubleshooting

Problem	Solution
The screen is blank or flickering	Adjust the contrast by twisting the potentiometer. If it's incorrectly adjusted, you won't be able to read the text. Also, check the potentiometer, and make sure it's connected correctly.
Not working at all	Double check the circuit's wiring. There are a lot of wires in this circuit, and it's easy to mix up one or two.
Rectangles in first row	If you see 16 rectangles (like "█") on the first row, it may be due to the jumper wires being loose on the breadboard. This is normal and can happen with other LCDs wired in parallel with a microcontroller. Make sure that the wires are fully inserted into the breadboard, then try pressing the reset button and adjusting the contrast using the potentiometer.
Still not working?	Jumper wires unfortunately can go "bad" from getting bent too much. The copper wire inside can break, leaving an open connection in your circuit. If you are certain that your circuit is wired correctly and that your code is error-free and uploaded but you are still encountering issues, try replacing one or more of the jumper wires for the component that is not working.

Circuit 4B: Temperature Sensor

Want to create a DIY environmental monitor or weather station? You can use a small, low-cost sensor like the TMP36 to make devices that track and respond to temperature. In this activity you will also use the LCD screen to display sensor readings, a common use for LCDs in electronics projects.

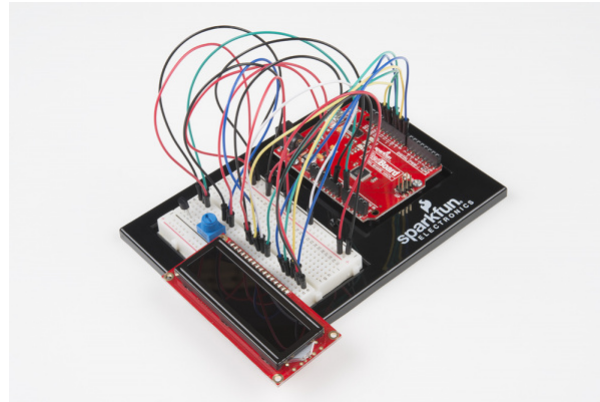

Parts Needed

Grab the following quantities of each part listed to build this circuit:



New Components

TMP36 Temperature Sensor

This temperature sensor has three legs. One connects to 5V, one to ground, and the voltage output from the third leg varies proportionally to changes in temperature. By doing some simple math with this voltage we can measure temperature in degrees Celsius or Fahrenheit.

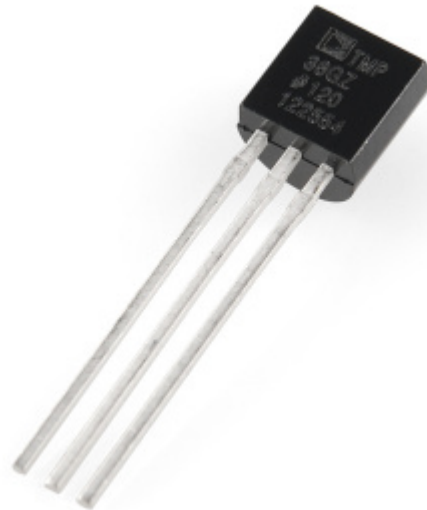

New Concepts

Algorithms

An algorithm is a process used in order to achieve a desired result. Often, the information needed to create an algorithm lives in the part's datasheet. This sketch uses a few formulas to turn a voltage value into a temperature value, making them all part of the larger temperature-retrieving algorithm. The first formula takes the voltage read

on analog pin 0 and multiplies it to get a voltage value from 0V–5V:

```
voltage = analogRead(A0) * 0.004882814;
```

The number we are multiplying by comes from dividing 5V by the number of samples the analog pin can read (1024), so we get: $5 / 1024 = 0.004882814$.

The second formula takes that 0–5V value and calculates degrees Centigrade:

```
degreesC = (voltage - 0.5) * 100.0;
```

The reason 0.5V is subtracted from the calculated voltage is because there is a 0.5V offset, mentioned on page 8 of the TMP36 datasheet. It's then multiplied by 100 to get a value that matches temperature.

The last formula takes the Centigrade temperature and converts it to a Fahrenheit temperature using the standard conversion formula:

```
degreesF = degreesC * (9.0/5.0) + 32.0;
```

Together, these three formulas make up the algorithm that converts voltage to degrees Fahrenheit.

Hardware Hookup

Polarized Components ⚠	Pay special attention to the component's markings indicating how to place it on the breadboard. Polarized components can only be connected to a circuit in one direction.
---------------------------	---

The temperature sensor is polarized and can only be inserted in one direction. See below for the pin outs of the temperature sensor. Pay very close attention to the markings on each side as you insert it into your circuit.

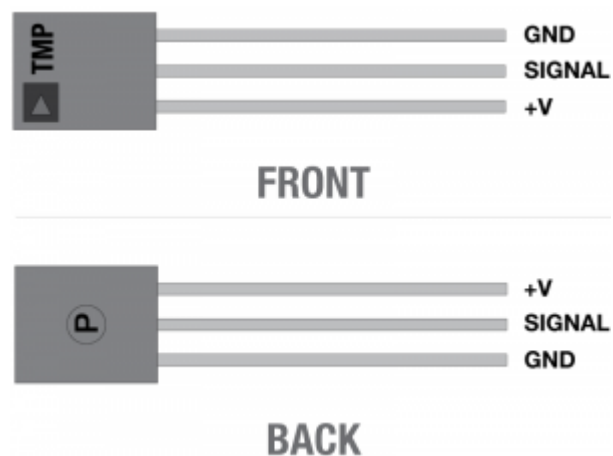

Heads up! Double check the polarity of the TMP36 temperature sensor before powering the RedBoard. It can become very hot if it is inserted backward!

Ready to start hooking everything up? Check out the circuit diagram and hookup table below to see how everything is connected.

Circuit Diagram

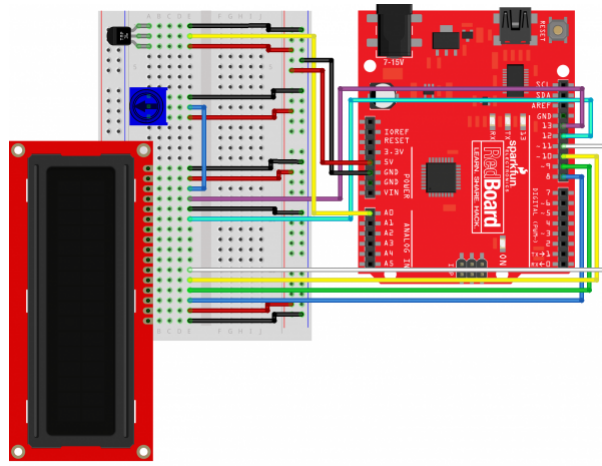

fritzing

Having a hard time seeing the circuit? Click on the image for a closer look.

Hookup Table

Component	RedBoard	Breadboard	Breadboard	Breadboard
Jumper Wire	5V	5V Rail (+)		
Jumper Wire	GND	GND Rail (-)		
LCD 		A15-A30 (Pin 1 on A15)		
Jumper Wire		E30	GND Rail (-)	
Jumper Wire		E29	5V Rail (+)	
Jumper Wire	Digital Pin 8	E28		
Jumper Wire	Digital Pin 9	E27		
Jumper Wire	Digital Pin 10	E26		
Jumper Wire	Digital Pin 11	E25		
Jumper Wire	Digital Pin 12	E20		
Jumper Wire		E19	GND Rail (-)	
Jumper Wire	Digital Pin 13	E18		
Jumper Wire		E16	5V Rail (+)	
Jumper Wire		E15	GND Rail (-)	
Potentiometer		A8	A9	A10
Jumper Wire		E9	E17	
Jumper Wire		E8	GND Rail (-)	

Jumper Wire		E10	5V Rail (+)	
TMP36 Temperature Sensor⚠		A1 (GND)	A2 (Signal)	A3 (V+)
Jumper Wire		E1	GND Rail (-)	
Jumper Wire	Analog Pin 0 (A0)	E2		
Jumper Wire		E3	5V Rail (+)	

*In the table, polarized components are shown with a warning triangle and the **whole row highlighted yellow**.*

Open the Sketch

To open the code, go to: **File > Examples > SIK_Guide_Code-V_4 > SIK_Circuit_4B-TemperatureSensor**

You can also copy and paste the following code into the Arduino IDE. Hit upload, and see what happens!

```

/*
SparkFun Inventor's Kit
Circuit 4B - Temperature Sensor

The LCD will display readings from a temperature sensor in degrees Celsius and Fahrenheit.

This sketch was written by SparkFun Electronics, with lots of help from the Arduino community.
This code is completely free for any use.

View circuit diagram and instructions at: https://learn.sparkfun.com/tutorials/sparkfun-inventor-s-kit-experiment-guide---v40
Download drawings and code at: https://github.com/sparkfun/SIK-Guide-Code
*/

#include <LiquidCrystal.h> //the liquid crystal libarry contains commands for p
rinting to the display
LiquidCrystal lcd(13, 12, 11, 10, 9, 8); // tell the RedBoard what pins are connected to the
display

float voltage = 0; //the voltage measured from the TMP36
float degreesC = 0; //the temperature in Celsius, calcuated from the vol
tage
float degreesF = 0; //the temperature in Farenheit, calcuated from the v
oltage

void setup() {

  lcd.begin(16, 2); //tell the lcd library that we are using a display t
hat is 16 characters wide and 2 characters high
  lcd.clear(); //clear the display
}

void loop() {

  voltage = analogRead(A0) * 0.004882814; //convert the analog reading, which varies from 0 to
1023, back to a voltage value from 0-5 volts
  degreesC = (voltage - 0.5) * 100.0; //convert the voltage to a temperature in degrees Ce
lsius
  degreesF = degreesC * (9.0/5.0) + 32.0; //convert the voltage to a temperature in dgrees Fah
renheit

  lcd.clear(); //clear the LCD

  lcd.setCursor(0,0); //set the cursor to the top left position
  lcd.print("Degrees C: "); //print a label for the data
  lcd.print(degreesC); //print the degrees Celsius

  lcd.setCursor(0,1); //set the cursor to the lower left position
  lcd.print("Degrees F: "); //print a label for the data
  lcd.print(degreesF); //print the degrees Fahreheit

  delay(1000); //delay for 1 second between each reading (this make

```

```
s the display less noisy)  
}
```

What You Should See

The LCD will show the temperature in Celsius and Fahrenheit. The temperature readings will update every second. An easy way to see the temperature change is to press your finger to the sensor.

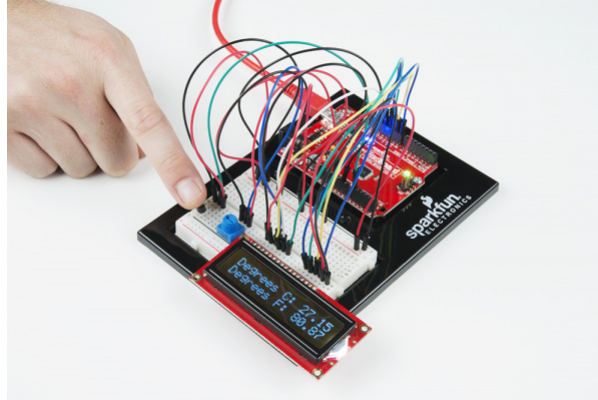

Program Overview

1. Get the analog value from the TMP36 and convert it back to a voltage between 0 and 5V.
2. Calculate the degrees Celsius from this voltage.
3. Calculate the degrees Fahrenheit from this voltage.
4. Clear the LCD.
5. Print the Degrees C with a label on the first row.
6. Print the Degrees F with a label on the second row.
7. Wait for a second before taking the next reading.

Code to Note

Code	Description
Voltage Conversion Algorithms	<p>Many of the sensors that you will use with your microcontroller work by changing a voltage in some predictable way in response to a property of the world (like temperature, light or magnetic fields). Often, you will need to build an algorithm that converts these voltages to the desired value and units. The temperature sensor is a great example of this code. We use three equations to convert a voltage value into degrees in C and F.</p> <pre>voltage = analogRead(A0) * 0.004882814; degreesC = (voltage - 0.5) * 100.0; degreesF = degreesC * (9.0/5.0) + 32.0;</pre>

Coding Challenges

Challenge	Description
Display the temperature in degrees Kelvin	Try adding an equation so that the temperature is displayed in degrees Kelvin (you will have to look up the formula for converting from degrees Celsius or Fahrenheit to Kelvin)

Display a bar graph	By changing the code you can display the temperature as a bar graph instead of a number.
Display values from another sensor	You can swap out the TMP36 for a potentiometer, photoresistor or other sensor and display the new set of values.
Add an RGB LED	Add an RGB LED that changes color based on the temperature.

Troubleshooting

Problem	Solution
Sensor is warm or hot to the touch	Make sure that you wired the temperature sensor correctly. The temperature sensor can get warm to the touch if it is wired incorrectly. Disconnect your microcontroller, rewire the circuit, and connect it back to your computer.
Temperature value is unchanging	Try pinching the sensor with your fingers to heat it up or pressing a bag of ice against it to cool it down. Also, make sure that the wires are connected properly to the temperature sensor.
Values not printing to screen	If you see text but no temperature values, there could be an error in your code. If you see no text at all, adjust the LCD contrast.

Circuit 4C: DIY Who Am I? Game

“DIY Who Am I?” is based on the popular Hedbanz game or HeadsUp! app. It’s a fun party game in which a player holds an LCD screen to his/her forehead so that the player can’t see the word(s) that appear on the screen. Other players have to give hints, act out charades or make noises that will make the player with the LCD guess the word(s).

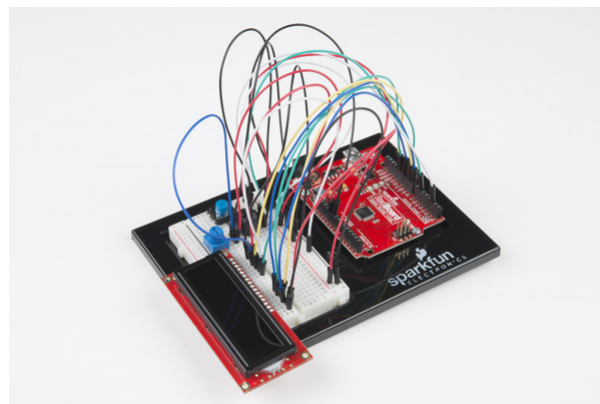

Parts Needed

Grab the following quantities of each part listed to build this circuit:



Need Battery holder image for parts list

New Components

4xAA Battery Holder

Included in your kit is a 4-cell AA battery holder. The 5-inch cable is terminated with a standard barrel jack connector. The connector mates with the barrel jack on the RedBoard, allowing you to easily make your project battery powered.



New Concepts

Button Debounce

When working with momentary buttons, it is usually necessary to add button debouncing to your code. This is because the code that is meant to execute when the button is pressed may execute faster than you can press and release the button (microcontrollers are fast!). The simplest way to debounce a button is to add a small delay to the end of your code. This sketch adds a 500 millisecond delay at the end of `loop()` to account for this. This simple addition will prevent a word from getting skipped when you press the button for the game.

For a more complex example of button debouncing, in the Arduino IDE click **File > Examples > 02.Digital > Debounce**.

Strings

Strings are used to print words and even sentences to an LCD or the Serial Monitor. Strings are actually just an array of characters with a null character at the end to let the program know where the end of the string is.

Arrays of Strings

In circuit 2A you used an array of characters to represent musical notes. In this program, you'll want to make an array of strings. Strings use multiple characters to make words, so you'll need to use a little trick to put them in an array. The trick is to use a pointer. When you declare your array, you'll use an asterisk after the char data type, as follows:

```
const char* arrayOfStrings = {"Feynman", "Sagan", "Tyson", "Nye"};
```

Pointers

Pointers are an advanced programming topic. They can be difficult to understand the first time you're introduced to them. For now, think of pointers as a variable that "points" to the value contained in a certain address in memory. In this sketch, the `char*` variable points to `arrayOfStrings` address and returns the character values to create a list of strings.

Hardware Hookup

<p>Polarized Components</p> <p>⚠</p>	<p>Pay special attention to the component's markings indicating how to place it on the breadboard. Polarized components can only be connected to a circuit in one direction.</p>
--------------------------------------	--

Batteries are polarized. They have a positive end and a negative end. The battery holder has images indicating which end goes in which orientation for each cell.

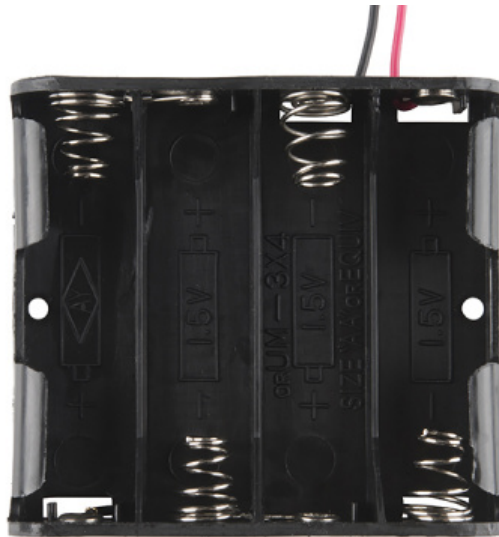

Ensure all the batteries are inserted correctly before plugging the battery holder into the RedBoard.

Battery Holder Attachment

To attach the battery holder to the breadboard baseplate, first cut two strips of Dual Lock that are roughly 1 inch x 1 inch each, or 2.5cm x 2.5cm. Remove the adhesive backing and attach one piece to the back of the battery holder.

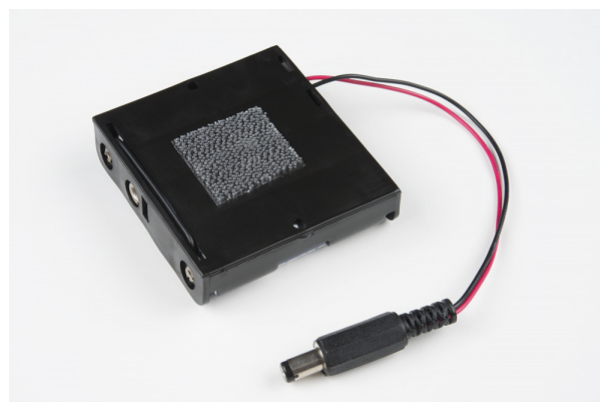

Adhere the second piece to the bottom of the breadboard baseplate (directly in the middle is recommended, as this will come into play in Project 5).

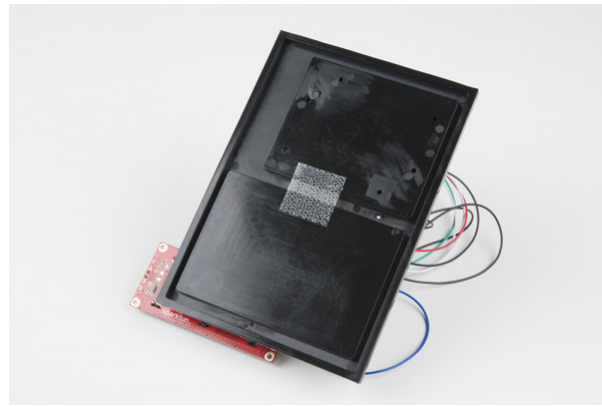

Last, press the battery holder to the baseplate so that the two pieces of Dual Lock snap together. Insert the batteries into the holder if you have not done so already. Remember that batteries are polarized and can only go in one way.

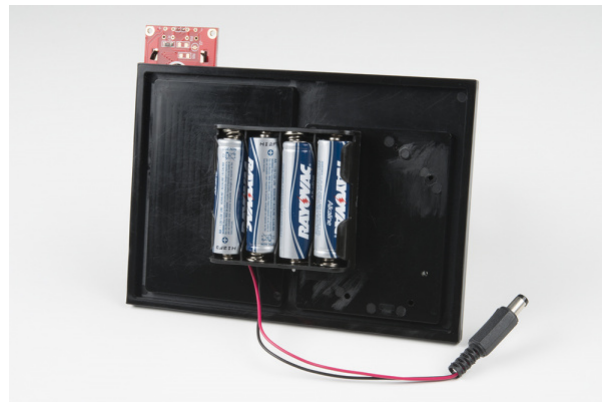

Remove the battery pack while building your circuit.

Ready to start hooking everything up? Check out the circuit diagram and hookup table below to see how everything is connected.

Circuit Diagram

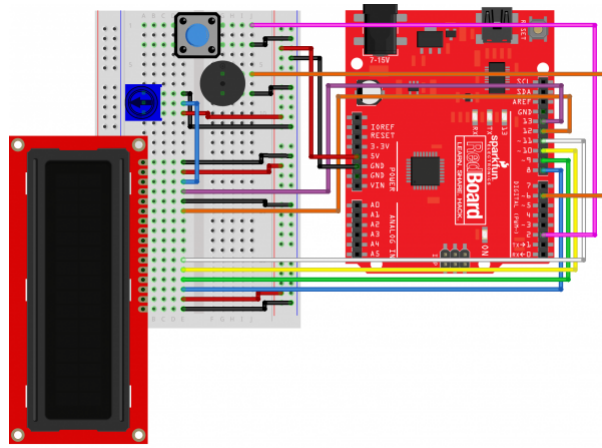

fritzing

Having a hard time seeing the circuit? Click on the image for a closer look.

Hookup Table

Component	RedBoard	Breadboard	Breadboard	Breadboard
Jumper Wire	5V	5V Rail (+)		
Jumper Wire	GND	GND Rail (-)		
LCD 		A15-A30 (Pin 1 on A15)		
Jumper Wire		E30	GND Rail (-)	
Jumper Wire		E29	5V Rail (+)	
Jumper Wire	Digital Pin 8	E28		
Jumper Wire	Digital Pin 9	E27		
Jumper Wire	Digital Pin 10	E26		
Jumper Wire	Digital Pin 11	E25		
Jumper Wire	Digital Pin 12	E20		
Jumper Wire		E19	GND Rail (-)	
Jumper Wire	Digital Pin 13	E18		
Jumper Wire		E16	5V Rail (+)	
Jumper Wire		E15	GND Rail (-)	
Potentiometer		A8	A9	A10
Jumper Wire		E9	E17	
Jumper Wire		E8	GND Rail (-)	

Jumper Wire		E10	5V Rail (+)	
Buzzer 		G6 (Buzzer +)	G8 (Buzzer -)	
Jumper Wire	Digital Pin 6	J6		
Jumper Wire		J8	GND Rail (-)	
Push Button		D1/D3	G1/G3	
Jumper Wire	Digital Pin 2	J1		
Jumper Wire		J3	GND Rail (-)	

*In the table, polarized components are shown with a warning triangle and the **whole row highlighted yellow**.*

Open the Sketch

To open the code, go to: **File > Examples > SIK_Guide_Code-V_4 > SIK_Circuit_4C-DIYWhoAmI**

You can also copy and paste the following code into the Arduino IDE. Hit upload, and see what happens!

```

    generateRandomOrder();                //generate an array of random numbers from 1-25 that will
    determine which order the words are shown in

    showStartSequence();                  //print the start sequence text
}

void loop() {

    for(int i=0; i<arraySize; i++){      //for each of the 25 words in the sequence

        lcd.clear();                     //clear off the array

        roundNumber = i+1;                //the array starts at 0, but the roundNumber will
        start counting from 1
        lcd.print(roundNumber);            //print the roundNumber (this is the current round
        number)
        lcd.print(": ");                  //spacer between the number and the word
        lcd.print(words[sequence[i]]);    //print a random word from the word array

        startTime = millis(); //record the time that this round started

        while(digitalRead(buttonPin) == HIGH){ //do this until the button is pressed...

            int roundedTime = round((timeLimit - (millis() - startTime))/1000); //calculate the time
            left in the round (dividing by 1000 converts the number to seconds
            lcd.setCursor(14,1);           //set the cursor in
            the lower right corner of the screen
            lcd.print(" ");
            lcd.setCursor(14,1);           //set the cursor in
            the lower right corner of the screen
            lcd.print(roundedTime);         //print the time left
            left in the time limit
            delay(15);

            if(millis() - startTime > timeLimit){ //if the time limit is up before the button
            is pressed
                gameOver();                 //end the game
            }

            if(digitalRead(buttonPin) == LOW){
                tone(buzzerPin, 272, 1);
            }

        } //exit this loop when the button is pressed

        delay(500); //delay for a moment before going on to the next round, so that the
        button press doesn't get registered twice

    }
    //if you finish all 25 words
    winner(); //show the you win message
}

```



```

//-----FUNCTIONS-----

//DISPLAYS A COUNTDOWN TO START THE GAME
void showStartSequence(){

    lcd.clear();                //clear the screen

    lcd.setCursor(0,0);         //move the cursor to the top left corner
    lcd.print("Category:");     //print "Category:"

    lcd.setCursor(0,1);         //move the cursor to the bottom left corner
    lcd.print("Animals");       //print "Animals:"

    delay(2000);                //Wait 2 seconds

    lcd.clear();                //clear the screen
    lcd.print("Get ready!");    //print "Get ready!"
    delay(1000);                //wait 1 second

    lcd.clear();                //clear the screen
    lcd.print("3");             //print "3"
    delay(1000);                //wait 1 second

    lcd.clear();                //clear the screen
    lcd.print("2");             //print "3"
    delay(1000);                //wait 1 second

    lcd.clear();                //clear the screen
    lcd.print("1");             //print "3"
    delay(1000);                //wait 1 second
}

//GENERATES A RANDOM ORDER FOR THE WORDS TO BE DISPLAYED
void generateRandomOrder(){

    randomSeed(analogRead(0));  //reset the random seed (Arduino needs this to generate
    truly random numbers

    for (int i = 0; i < 24; i++){ //do this until all 25 positions are filled

        int currentNumber = 0;   //variable to hold the current number
        boolean match = false;    //does the currentNumber match any of the previous numbe
rs?

        //generate random numbers until you've generated one that doesn't match any of the other num
bers in the array
        do {
            currentNumber = random(0,arraySize); //generate a random number from 1-25
            match = false;                       //we haven't checked for matches yet, so start b
y assuming that it doesn't match
            for (int i = 0; i < arraySize; i++){ //for all 25 numbers in the array
                if (currentNumber == sequence[i]){ //does the currentNumber match any of the number
s?

```

```

        match = true;                                //if so, set the match variable to true
    }
}
} while(match == true);                            //if the match variable is true, generate another
r random number and try again
    sequence[i] = currentNumber;                    //if the match variable is false (the new number
is unique) then add it to the sequence
}
}

//GAME OVER
void gameOver(){
    lcd.clear();                                    //clear the screen

    lcd.setCursor(0,0);                             //move the cursor the top left corner
    lcd.print("Game Over");                          //print "Game Over"

    lcd.setCursor(0,1);                             //move to the bottom row
    lcd.print("Score: ");                            //print a label for the score
    lcd.print(roundNumber);                          //print the score (the round number is the same as the score)

    //play the losing fog horn
    tone(buzzerPin, 130, 250);                       //E6
    delay(275);
    tone(buzzerPin, 73, 250);                        //G6
    delay(275);
    tone(buzzerPin, 65, 150);                       //E7
    delay(175);
    tone(buzzerPin, 98, 500);                       //C7
    delay(500);

    while(true){}                                   //get stuck in this loop forever
}

//WINNER
void winner(){
    lcd.clear();                                    //clear the screen

    lcd.setCursor(7,0);                             //move the cursor to the top center of the screen
    lcd.print("YOU");                                //print "You"

    lcd.setCursor(7,1);                             //move the cursor to the bottom center of the screen
    lcd.print("WIN!");                              //print "WIN!"

    //play the 1Up noise
    tone(buzzerPin, 1318, 150);                     //E6
    delay(175);
    tone(buzzerPin, 1567, 150);                     //G6
    delay(175);
    tone(buzzerPin, 2637, 150);                     //E7
    delay(175);
    tone(buzzerPin, 2093, 150);                     //C7
    delay(175);
    tone(buzzerPin, 2349, 150);                     //D7

```

```

delay(175);
tone(buzzerPin, 3135, 500);    //G7
delay(500);

while(true){                    //get stuck in this loop forever
}

```

What You Should See

The game will begin with a prompt telling you the category of words. Then it will run through a short countdown. When the first round starts, the word to be guessed will be displayed in the top left, and a countdown will be displayed in the bottom right of the LCD screen. Each time the button is pressed (before the timer expires) a new word will be displayed. If you win or lose, a short song will play and text will be displayed.



Program Overview

1. Generate a random order for the words to be displayed.
2. Show the starting countdown on the LCD.
3. Start a loop that will run 25 times (there are 25 words total). For each round:
 - a. Print the round number and the word to be guessed.
 - b. Display a countdown timer in the lower right-hand corner of the screen that counts down the time limit for each round.
 - c. If the time limit runs out, play the losing song, print "Game Over" and show the player's final score.
 - d. If the player presses the button before the time limit is up, advance to the next word.
4. If the player gets through all 25 words, play the winning song and print "YOU WIN!"

Code to Note

Code	Description
Array of Strings: <pre>const char* array_name [array_length] = {"string1", "string2"...}</pre>	Makes an array of strings. The strings are stored as constants, so they can't be changed once the program starts.
Rounding function: <pre>round(value_to_round);</pre>	This math function rounds a number up or down to the nearest whole number.
Random Function: <pre>random(min, max);</pre>	The random function takes a set of numbers and generates a pseudo-random number from that set.

Button Debounce: <code>delay(500);</code>	This 500 millisecond delay at the end of the loop adds button debounce so that erroneous button presses are not detected by the RedBoard.
User Functions	Description
<code>generateRandomOrder();</code>	Makes an array that is a random ordering of the numbers from 1-25. This is used to display words for the game in a random order.
<code>showStartSequence();</code>	Shows the category of words on the LCD, then displays a countdown before the game starts.
<code>gameOver();</code>	Plays a sound and shows the text "Game Over" along with the player's final score.
<code>winner();</code>	Shows the text "YOU WIN!" and plays a winning sound.

Coding Challenges

Challenge	Description
Change the time limit	Changing the time limit variable will change the difficulty of the game.
Change the words in the word list	Try changing the categories and words. The number of words in your words array must match the value of the variable "arraySize".
Change the winning and losing songs	By changing the tones in the winner() and gameover() functions you can change which song plays at the end of the game.

Troubleshooting

Problem	Solution
The screen is blank or flickering	Adjust the contrast by twisting the potentiometer. If it's incorrectly adjusted, you won't be able to read the text. Also, check the potentiometer to make sure it's connected correctly.
No sound is coming from the buzzer	Check the wiring from the buzzer. Make sure you are using the correct pin as defined in your code. You may add a potentiometer volume knob if you desire.
The button doesn't work or words are getting skipped before they are guessed	If the button isn't working, check your wiring. If words are being skipped when the button is pressed, increase the debounce delay found at the end of the loop. It should be 500 milliseconds by default. Increasing this number by tiny increments will help with this problem.

Project 5: Robot

Ah, robots. One of the most iconic and exciting electronics applications. In this project you will learn all about DC motors and motor drivers by building your own robot! You'll learn how to control a tethered robot first by sending it commands over serial. Then you will unleash your robot by removing the tether and making it autonomous.

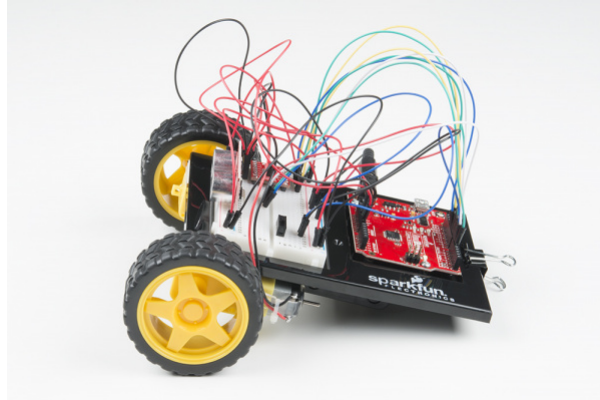

New Components Introduced in This Project

Each of the components listed below will be described in more detail as you progress through each circuit.

- TB6612FNG Motor Driver
- Switch
- DC Gearmotor
- Wheel

New Concepts Introduced in This Project

Each of the concepts listed below will be described in more detail as you progress through each circuit.

- Input Voltage
- Integrated Circuits
- H-Bridge Motor Driver
- ASCII Characters
- Converting Strings
- Autonomous Vehicles

You Will Learn

- How to control two motors using a motor driver
- How to send serial commands to create a remote-controlled robot
- How to build a robot that uses sensors to react to its environment

Circuit 5A: Motor Basics

In this circuit you will learn the basic concepts behind motor control. Motors require a lot of current, so you can't drive them directly from a digital pin on the RedBoard. Instead, you'll use what is known as a motor controller or motor driver board to power and spin the motor accordingly.

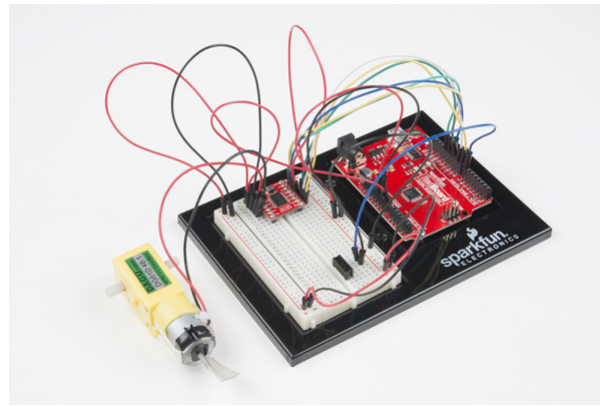

Parts Needed

Grab the following quantities of each part listed to build this circuit:

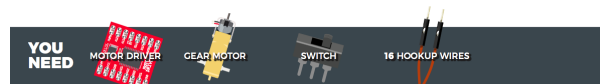

Need parts images for motor driver, switch, motors and wheels.

New Components

Switch

A switch is a component that controls the open-ness or closed-ness of an electric circuit. Just like the momentary buttons used in earlier circuits, a switch can only exist in one of two states: open or closed. However, a switch is different in that it will stay in the position it was last in until it is switched again.



DC Gearmotors

The motors in your Inventor's Kit have two main parts: a small DC motor that spins quickly and a plastic gearbox that gears down that output from the hobby motor so that it is slower but stronger, allowing it to move your robot. The motors have a clever design so that you can attach things that you want to spin fast (like a small fan or flag) to the hobby motor, and things that you want to be strong (like a wheel) to the plastic axle sticking out the side of the motor. The included wheels just so happen to fit on the plastic axles.



Inside the hobby motor are coils of wire that generate magnetic fields when electricity flows through them. When power is supplied to these electromagnets, they spin the drive shaft of the motor.

TB6612FNG Motor Driver

If you switch the direction of current through a motor by swapping the positive and negative leads, the motor will spin in the opposite direction. Motor controllers contain a set of switches (called an H-bridge) that let you easily control the direction of one or more motors. The TB6612FNG Motor Driver takes commands for each motor over three wires (two wires control direction, and one controls speed), then uses these signals to control the current through two wires attached to your motor.

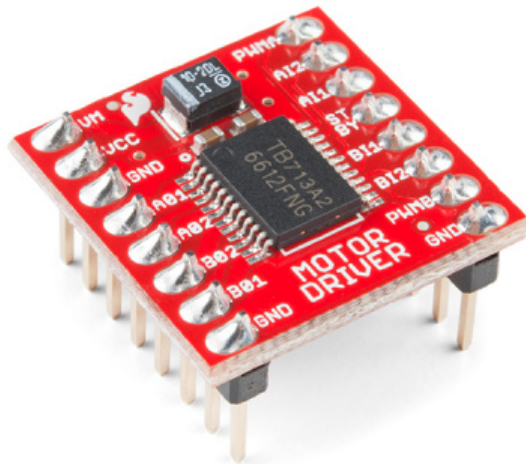

New Concepts

Voltage In (VIN)

This circuit utilizes the VIN pin found with the other power pins. The VIN pin outputs a voltage that varies based on whatever voltage the RedBoard is powered with. If the RedBoard is powered through the USB port, then the voltage on VIN will be about 4.6–5V. However, if you power the RedBoard through the barrel jack (highlighted in the picture below), the VIN pin will reflect that voltage. For example, if you were to power the barrel jack with 9V, the voltage out on VIN would also be 9V.

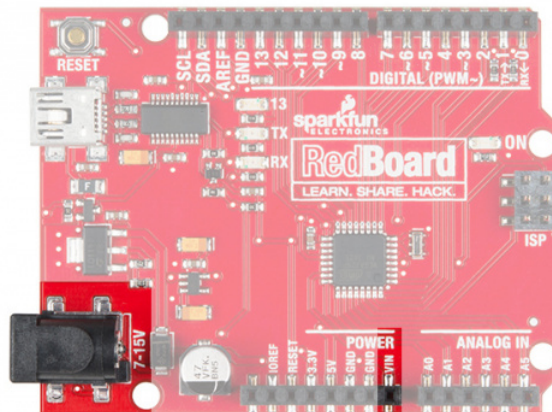

Integrated Circuits (ICs) and Breakout Boards

An Integrated Circuit (IC) is a collection of electronic components — resistors, transistors, capacitors, etc. — all stuffed into a tiny chip and connected together to achieve a common goal. They come in all sorts of flavors, shapes and sizes. The chip that powers the RedBoard, the ATmega328, is an IC. The chip on the motor driver, the TB6612FNG, is another IC, one designed to control motors, referred to as an H-bridge.

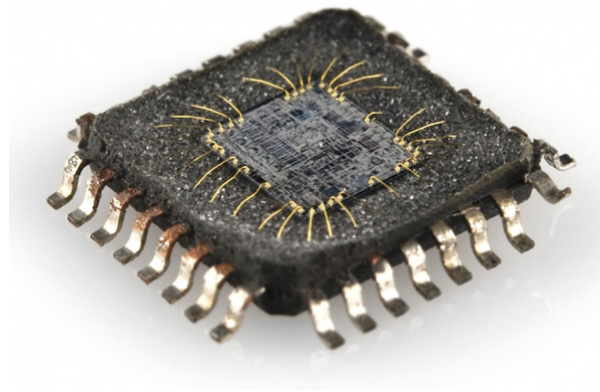

The guts of an integrated circuit, visible after removing the top.

Integrated circuits are often too small to work with by hand. To make working with ICs easier and to make them breadboard-compatible, they are often added to a breakout board, which is a printed circuit board that connects all the IC's tiny legs to larger ones that fit in a breadboard. The motor driver board in your kit is an example of a breakout board.

Hardware Hookup

Polarized Components ⚠	Pay special attention to the component's markings indicating how to place it on the breadboard. Polarized components can only be connected to a circuit in one direction.
------------------------------	---

Most ICs have polarity and usually have a polarity marking in one of the corners. The motor driver is no exception. Be sure to insert the motor driver as indicated in the circuit diagrams. The motor driver pins are shown in the image below.

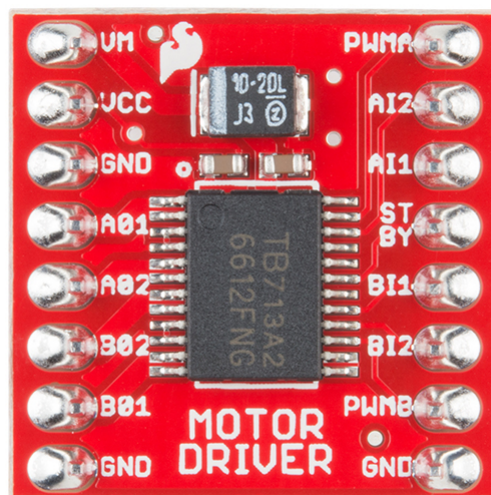

Each pin and its function is covered in the table below.

Pin Label	Function	Power/Input/Output	Notes
VM	Motor Voltage	Power	This is where you provide power for the motors (2.2V to 13.5V)

VCC	Logic Voltage	Power	This is the voltage to power the chip and talk to the microcontroller (2.7V to 5.5V)
GND	Ground	Power	Common Ground for both motor voltage and logic voltage (all GND pins are connected)
STBY	Standby	Input	Allows the H-bridges to work when high (has a pulldown resistor so it must actively be pulled high)
AIN1/BIN1	Input 1 for channels A/B	Input	One of the two inputs that determines the direction
AIN2/BIN2	Input 2 for channels A/B	Input	One of the two inputs that determines the direction
PWMA/PWMB	PWM input for channels A/B	Input	PWM input that controls the speed
A01/B01	Output 1 for channels A/B	Output	One of the two outputs to connect the motor
A02/B02	Output 2 for channels A/B	Output	One of the two outputs to connect the motor

When you're finished with Project 5, removing the motor driver from the breadboard can be difficult due to its numerous legs. To make this easier, use the included screwdriver as a lever to gently pry it out. Be careful not to bend the legs as you remove it.

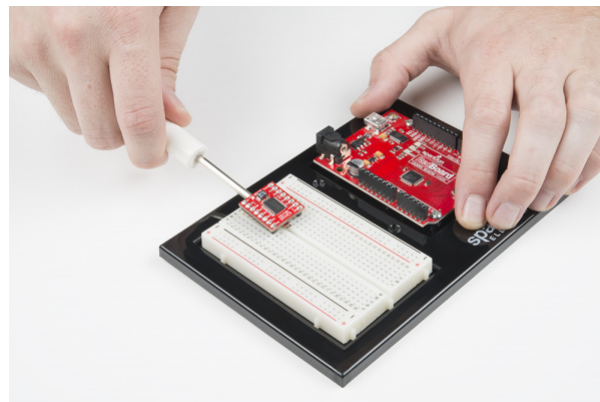

The motors are also polarized. However, motors are unique in that they will still work when the two connections are reversed. They will just spin in the opposite direction when hooked up backward. To keep things simple, always think of the red wire as positive (+) and the black wire as negative (-).

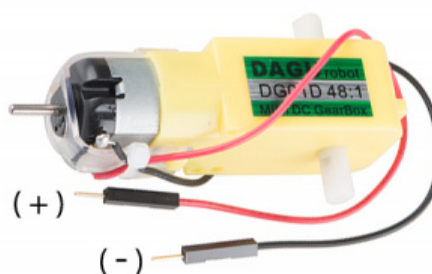

Last, the switch is **not** polarized. It works the same no matter its orientation.

Ready to start hooking everything up? Check out the circuit diagram and hookup table below to see how everything is connected.

Circuit Diagram

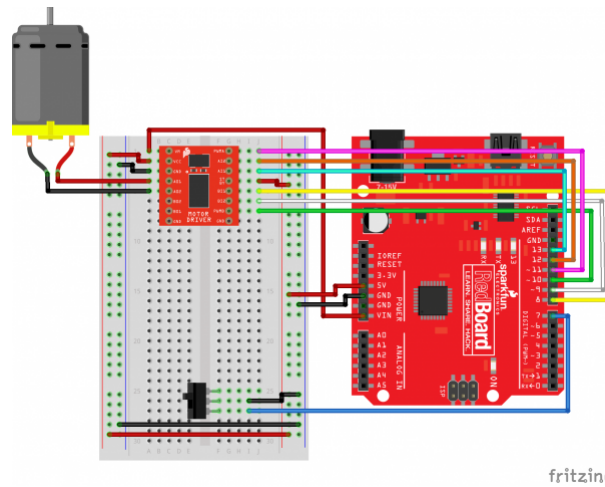

fritzing

Having a hard time seeing the circuit? Click on the image for a closer look.

Hookup Table

Component	RedBoard	Breadboard	Breadboard	Breadboard
Jumper Wire	5V	5V Rail (+)		
Jumper Wire	GND	GND Rail (-)		
Jumper Wire		5V Rail (+)	5V Rail (+)	
Jumper Wire		GND Rail (-)	GND Rail (-)	
Jumper Wire	VIN	A1		
Motor Driver ⚠		C1-C8 (VM on C1)	G1-G8 (PWMA on G1)	
Jumper Wire		A2	5V Rail (+)	
Jumper Wire		A3	GND Rail (-)	
Jumper Wire	Digital Pin 8	J5		
Jumper Wire	Digital Pin 9	J6		
Jumper Wire	Digital Pin 10	J7		
Jumper Wire		J4	5V Rail (+)	
Jumper Wire	Digital Pin 11	J1		
Jumper Wire	Digital Pin 12	J2		

Jumper Wire	Digital Pin 13	J3		
Motor 		A4 (Red +)	A5 (Black -)	
Switch		F25	F26	F27
Jumper Wire		I26	GND Rail (-)	
Jumper Wire	Digital Pin 7	I27		

*In the table, polarized components are shown with a warning triangle and the **whole row highlighted yellow**.*

Open the Sketch

To open the code, go to: **File > Examples > SIK_Guide_Code-V_4 > SIK_Circuit_5A-MotorBasics**.

You can also copy and paste the following code into the Arduino IDE. Hit upload, and see what happens!

```

/*
SparkFun Inventor's Kit
Circuit 5A - Motor Basics

Learn how to control one motor with the motor driver.

This sketch was written by SparkFun Electronics, with lots of help from the Arduino community.
This code is completely free for any use.

View circuit diagram and instructions at: https://learn.sparkfun.com/tutorials/sparkfun-inventor-s-kit-experiment-guide---v40
Download drawings and code at: https://github.com/sparkfun/SIK-Guide-Code
*/

//PIN VARIABLES
//the motor will be controlled by the motor A pins on the motor driver
const int AIN1 = 13;           //control pin 1 on the motor driver for the right motor
const int AIN2 = 12;           //control pin 2 on the motor driver for the right motor
const int PWMA = 11;           //speed control pin on the motor driver for the right motor

int switchPin = 7;             //switch to turn the robot on and off

//VARIABLES
int motorSpeed = 0;           //starting speed for the motor

void setup() {
  pinMode(switchPin, INPUT_PULLUP); //set this as a pullup to sense whether the switch is flipped

  //set the motor control pins as outputs
  pinMode(AIN1, OUTPUT);
  pinMode(AIN2, OUTPUT);
  pinMode(PWMA, OUTPUT);

  Serial.begin(9600);           //begin serial communication with the computer

  Serial.println("Enter motor speed (0-255)... "); //Prompt to get input in the serial monitor.
}

void loop() {
  if (Serial.available() > 0){ //if the user has entered something in the serial monitor
    motorSpeed = Serial.parseInt(); //set the motor speed equal to the number in the serial message

    Serial.print("Motor Speed: "); //print the speed that the motor is set to run at
    Serial.println(motorSpeed);
  }

  if(digitalRead(7) == LOW){ //if the switch is on...
    spinMotor(motorSpeed);
  }
}

```

```

} else{
    spinMotor(0);
}

}

/*****
void spinMotor(int motorSpeed) //function for driving the right motor
{
    if (motorSpeed > 0) //if the motor should drive forward (positive speed)
    {
        digitalWrite(AIN1, HIGH); //set pin 1 to high
        digitalWrite(AIN2, LOW); //set pin 2 to low
    }
    else if (motorSpeed < 0) //if the motor should drive backward (negative speed)
    {
        digitalWrite(AIN1, LOW); //set pin 1 to low
        digitalWrite(AIN2, HIGH); //set pin 2 to high
    }
    else //if the motor should stop
    {
        digitalWrite(AIN1, LOW); //set pin 1 to low
        digitalWrite(AIN2, LOW); //set pin 2 to low
    }
    analogWrite(PWMA, abs(motorSpeed)); //now that the motor direction is set, drive it at the entered speed
}

```

What You Should See

When you flip the switch, the motor will turn on and spin at the speed set by the motor speed variable (default is 0). By opening the serial monitor and sending numbers, you can change the speed of the motor. Any number from about 130 to 255 or -130 to -255 will work, though changes in the speed will be hard to notice. Send the number 0 to stop the motor. Adding a piece of tape to the motor shaft makes it easier to see it spinning.

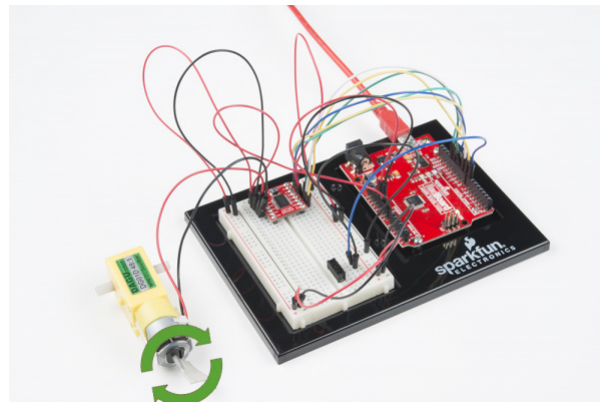

Program Overview

1. Check to see if a command has been sent through the Serial Monitor. If a command has been sent, then set the motor speed to the number that was sent over the Serial Monitor.

2. Check to see if the switch is ON or OFF.
 - a. If the switch is ON, drive the motor at the motor speed.
 - b. If the switch is OFF, stop the motor.

Code to Note

Code	Description
Parsing Integers: <code>Serial.parseInt();</code>	<code>parseInt()</code> receives integer numbers from the serial monitor. It returns the value of the number that it receives, so you can use it like a variable.
Serial Available: <code>Serial.available();</code>	<code>Serial.available()</code> checks how many bytes of data are being sent to the RedBoard. If it is greater than 0, then a message has been sent. It can be used in an if statement to run code only when a command has been received.

Coding Challenges

Challenge	Description
Make the switch change directions	Change the code so that the position of the switch changes the direction of the motor instead of turning it on and off.
Replace the switch with a button	Try wiring a button into the circuit instead of the sliding switch. Now the motor only turns on when you push the button.
Replace the switch with a sensor	Try changing the code so that the motor is activated by another sensor, like the photoresistor.

Troubleshooting

Problem	Solution
Motor not spinning	Check the wiring to the motor driver. There are a lot of connections, and it's easy to mix one of them up with another. If it is still not working, you can test the B channel by moving you motor. (Black wire to A6, Red wire to A7). You'll need to change the code as well.
Motor spins but then stops	In the Serial Monitor, make sure you have No line ending selected in the drop down menu next to the Baud Rate drop down menu.
Switch not working	Make sure that you are hooked up to the middle pin and one side pin on the switch.
Still not working?	Jumper wires unfortunately can go "bad" from getting bent too much. The copper wire inside can break, leaving an open connection in your circuit. If you are certain that your circuit is wired correctly and that your code is error-free and uploaded but you are still encountering issues, try replacing one or more of the jumper wires for the component that is not working.

Circuit 5B: Remote-Controlled Robot

It's remote control time! In this circuit, you'll use a motor driver to control the speed and direction of two motors. You will also learn how to read multiple pieces of information from one serial command so that you can use the Serial Monitor to tell the robot what direction to move in and how far to move.

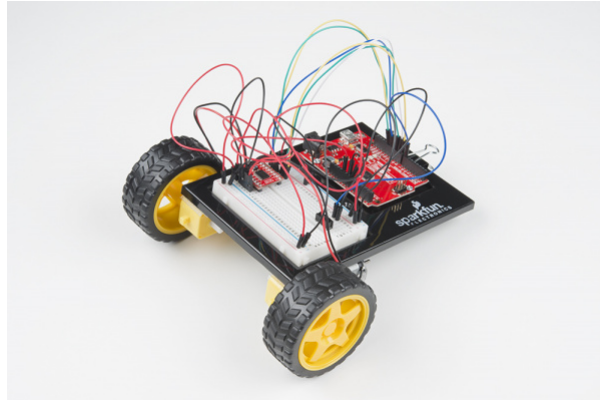

Parts Needed

Grab the following quantities of each part listed to build this circuit:

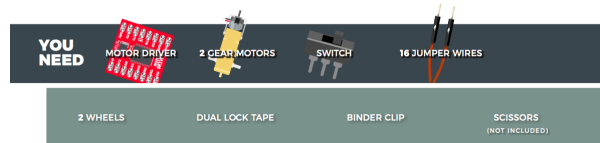

Need parts images for motor driver, switch, motors and wheels.

Additional Materials

- Scissors

New Concepts

ASCII Characters

ASCII is a standard formalized in the 1960s that assigns numbers to characters. This is a method of character encoding. When typing on a computer keyboard, each character you type has a number associated with it. This is what allows computers to know whether you are typing a lowercase “a,” an uppercase “A” or a random character such as ampersand (&). In this experiment, you will be sending characters to the Serial Monitor to move your remote control robot. When you send a character, the microcontroller is actually interpreting that as a specific number. There are tons of ASCII tables available online. These tables make it easier to know which character is represented by which number.

Converting Strings to Integers

String variables hold words like “dog” or “Robert Smith” that are made up of multiple characters. Arduino has a set of special built-in methods for string variables that you can call by putting a period after the variable name, as follows:

```
string_variable_name.toInt();
```

The `.toInt()` method converts the string to a number, and there are a dozen other methods that can do things like tell you the length of a word or change all of the characters in a string to uppercase or lowercase.

Hardware Hookup

Polarized
Components



Pay special attention to the component's markings indicating how to place it on the breadboard. Polarized components can only be connected to a circuit in one direction.

Before you build this circuit, you'll need to make a few modifications to the breadboard baseplate to make it more robot-like!

Assembling the Robot

Using scissors, cut two strips of Dual Lock that are 1.25 inches (3.175cm) long and 1 inch (2.5cm) wide. Remove the adhesive backing, and attach the two pieces to the very corners of the baseplate on the side located under the breadboard.

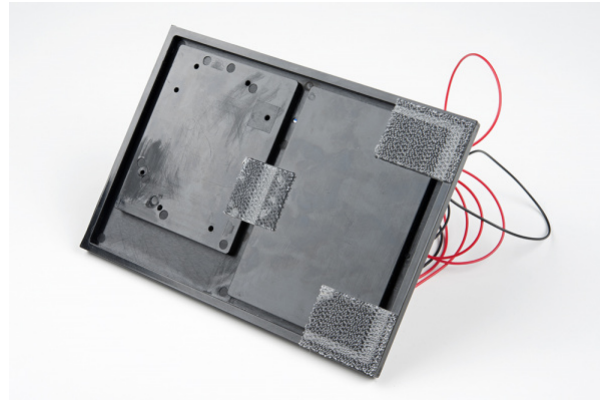

Note: You will likely have a piece of Dual Lock in the center of your baseplate from Project 4. Leave it if so. It will be used in the next circuit.

Cut two more strips that are 1.25 inches (3.175cm) long and $\frac{3}{4}$ inch (1.9cm) wide. Remove the adhesive backing, and attach the strips to the two motors. Be sure that your motors are **mirror images** of each other when you attach the Dual Lock.

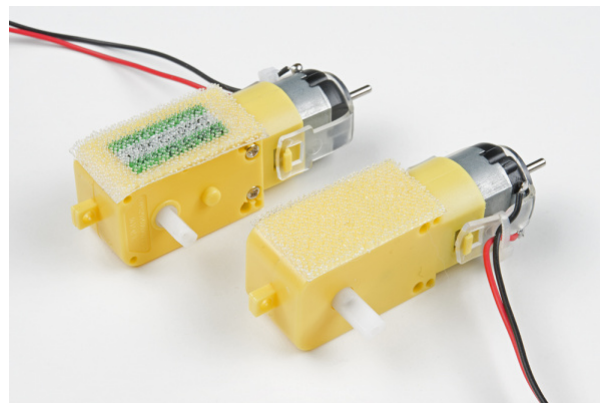

Press the motors to the baseplate, connecting the two Dual Lock surfaces. Try to get the motors as straight as possible so your robot will drive straight.

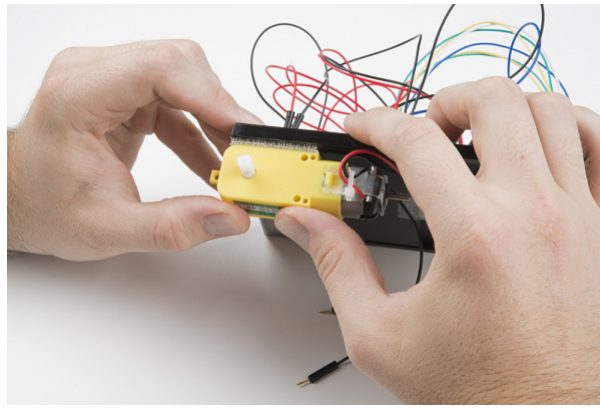

The bottom of your baseplate should look like the image below. Remember that the two motors should be mirror images of each other.

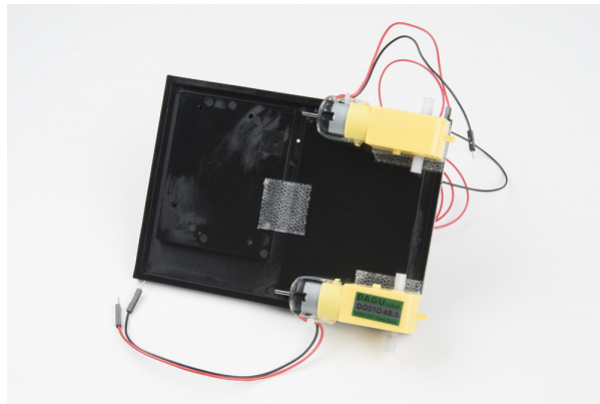

Note: The direction in which the motor wires face is arbitrary. Having them face out makes the circuit easier to build. Having them face in makes the circuit more robust against wires getting ripped out.

Attach the wheels by sliding them onto the plastic shafts on the gearmotor. The shaft is flat on one side, as is the wheel coupler. Align the two, and then press to fit the wheel onto the shaft.

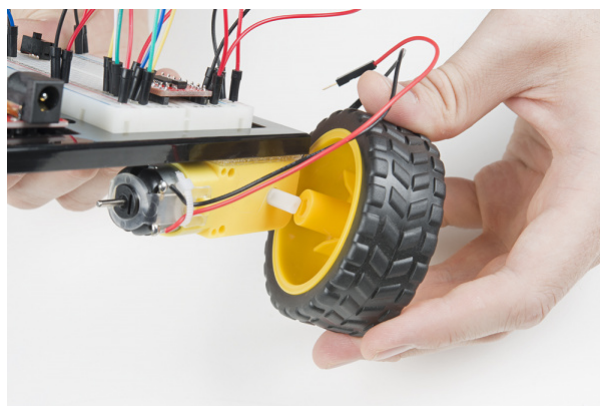

Last, clip the binder clip onto the back end of the robot. This will act as a caster as the robot drives around.

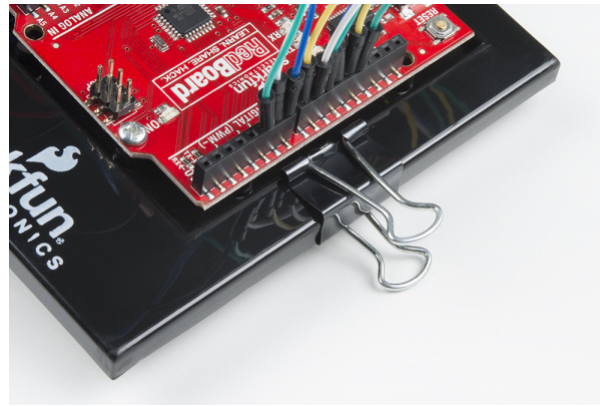

Once you're finished, it's time to build the circuit. You may choose to remove the motors or leave them on while you build the circuit.

Ready to start hooking everything up? Check out the circuit diagram and hookup table below to see how everything is connected.

Circuit Diagram

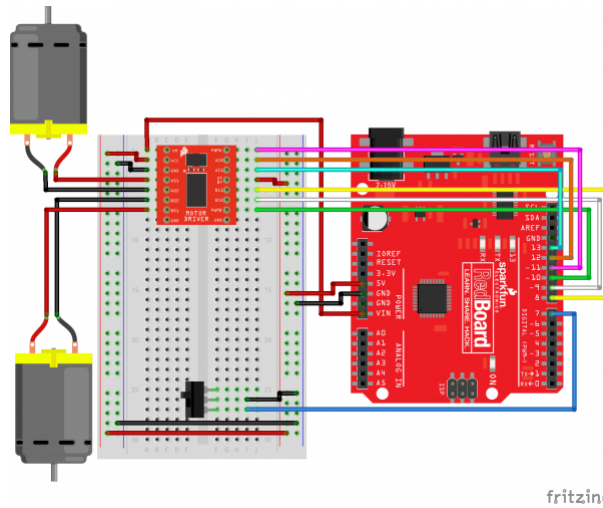

Having a hard time seeing the circuit? [Click on the image for a closer look.](#)

Hookup Table

Component	RedBoard	Breadboard	Breadboard	Breadboard
Jumper Wire	5V	5V Rail (+)		
Jumper Wire	GND	GND Rail (-)		
Jumper Wire		5V Rail (+)	5V Rail (+)	
Jumper Wire		GND Rail (-)	GND Rail (-)	
Jumper Wire	VIN	A1		
Motor Driver 		C1-C8 (VM on C1)	G1-G8 (PWMA on G1)	
Jumper Wire		A2	5V Rail (+)	

Jumper Wire		A3	GND Rail (-)	
Jumper Wire	Digital Pin 8	J5		
Jumper Wire	Digital Pin 9	J6		
Jumper Wire	Digital Pin 10	J7		
Jumper Wire		J4	5V Rail (+)	
Jumper Wire	Digital Pin 11	J1		
Jumper Wire	Digital Pin 12	J2		
Jumper Wire	Digital Pin 13	J3		
Motor 1 (Right) ⚠		A4 (Red +)	A5 (Black -)	
Motor 2 (Left) ⚠		A6 (Black -)	A7 (Red +)	
Switch		F25	F26	F27
Jumper Wire		I26	GND Rail (-)	
Jumper Wire	Digital Pin 7	I27		

*In the table, polarized components are shown with a warning triangle and the **whole row highlighted yellow**.*

Open the Sketch

To open the code, go to: **File > Examples > SIK_Guide_Code-V_4 > SIK_Circuit_5B-RemoteControlRobot**

You can also copy and paste the following code into the Arduino IDE. Hit upload, and see what happens!

```

/*
SparkFun Inventor's Kit
Circuit 5B - Remote Control Robot

Control a two wheeled robot by sending direction commands through the serial monitor.
This sketch was adapted from one of the activities in the SparkFun Guide to Arduino.
Check out the rest of the book at
https://www.sparkfun.com/products/14326

This sketch was written by SparkFun Electronics, with lots of help from the Arduino community.
This code is completely free for any use.

View circuit diagram and instructions at: https://learn.sparkfun.com/tutorials/sparkfun-inventor
s-kit-experiment-guide---v40
Download drawings and code at: https://github.com/sparkfun/SIK-Guide-Code
*/

//the right motor will be controlled by the motor A pins on the motor driver
const int AIN1 = 13;           //control pin 1 on the motor driver for the right motor
const int AIN2 = 12;           //control pin 2 on the motor driver for the right motor
const int PWMA = 11;           //speed control pin on the motor driver for the right motor

//the left motor will be controlled by the motor B pins on the motor driver
const int PWMB = 10;           //speed control pin on the motor driver for the left motor
const int BIN2 = 9;            //control pin 2 on the motor driver for the left motor
const int BIN1 = 8;            //control pin 1 on the motor driver for the left motor

int switchPin = 7;             //switch to turn the robot on and off

const int driveTime = 20;      //this is the number of milliseconds that it takes the robot to d
rive 1 inch
                                //it is set so that if you tell the robot to drive forward 25 uni
ts, the robot drives about 25 inches

const int turnTime = 8;        //this is the number of milliseconds that it takes to turn the ro
bot 1 degree
                                //it is set so that if you tell the robot to turn right 90 units,
the robot turns about 90 degrees

                                //Note: these numbers will vary a little bit based on how you mou
nt your motors, the friction of the
                                //surface that your driving on, and fluctuations in the power to
the motors.
                                //You can change the driveTime and turnTime to make them more acc
urate

String botDirection;           //the direction that the roobt will drive in (this change which d
irection the two motors spin in)
String distance;                //the distance to travel in each direction

/*****/
void setup()

```

```

{
  pinMode(switchPin, INPUT_PULLUP); //set this as a pullup to sense whether the switch is flip
  ped

  //set the motor contro pins as outputs
  pinMode(AIN1, OUTPUT);
  pinMode(AIN2, OUTPUT);
  pinMode(PWMA, OUTPUT);

  pinMode(BIN1, OUTPUT);
  pinMode(BIN2, OUTPUT);
  pinMode(PWMB, OUTPUT);

  Serial.begin(9600); //begin serial communication with the computer

  //prompt the user to enter a command
  Serial.println("Enter a diredion followed by a distance.");
  Serial.println("f = forward, b = backward, r = turn right, l = turn left");
  Serial.println("Example command: f 50");
}

/*****/
void loop()
{
  if(digitalRead(7) == LOW)
  {
    //if the switch is in the ON position
    if (Serial.available() > 0) //if the user has sent a command to the
    RedBoard
    {
      botDirection = Serial.readStringUntil(' '); //read the characters in the command unt
      il you reach the first space
      distance = Serial.readStringUntil(' '); //read the characters in the command unt
      il yuo reach the second space

      //print the command that was just received in the serial monitor
      Serial.print(botDirection);
      Serial.print(" ");
      Serial.println(distance.toInt());

      if(botDirection == "f") //if the entered direction is forward

      {
        rightMotor(200); //drive the right wheel forward
        leftMotor(200); //drive the left wheel forward
        delay(driveTime * distance.toInt()); //drive the motors long enough travel th
        e entered distance
        rightMotor(0); //turn the right motor off
        leftMotor(0); //turn the left motor off
      }
      else if(botDirection == "b") //if the entered direction is backward
      {
        rightMotor(-200); //drive the right wheel forward
        leftMotor(-200); //drive the left wheel forward
        delay(driveTime * distance.toInt()); //drive the motors long enough travel th

```

```

e entered distance
    rightMotor(0); //turn the right motor off
    leftMotor(0); //turn the left motor off
}
else if(botDirection == "r") //if the entered direction is right
{
    rightMotor(-200); //drive the right wheel forward
    leftMotor(255); //drive the left wheel forward
    delay(turnTime * distance.toInt()); //drive the motors long enough turn the
entered distance
    rightMotor(0); //turn the right motor off
    leftMotor(0); //turn the left motor off
}
else if(botDirection == "l") //if the entered direction is left
{
    rightMotor(255); //drive the right wheel forward
    leftMotor(-200); //drive the left wheel forward
    delay(turnTime * distance.toInt()); //drive the motors long enough turn the
entered distance
    rightMotor(0); //turn the right motor off
    leftMotor(0); //turn the left motor off
}
}
}
else
{
    rightMotor(0); //turn the right motor off
    leftMotor(0); //turn the left motor off
}
}
/*****/
void rightMotor(int motorSpeed) //function for driving the right motor
{
    if (motorSpeed > 0) //if the motor should drive forward (posit
ive speed)
    {
        digitalWrite(AIN1, HIGH); //set pin 1 to high
        digitalWrite(AIN2, LOW); //set pin 2 to low
    }
    else if (motorSpeed < 0) //if the motor should drive backwar (negat
ive speed)
    {
        digitalWrite(AIN1, LOW); //set pin 1 to low
        digitalWrite(AIN2, HIGH); //set pin 2 to high
    }
    else //if the motor should stop
    {
        digitalWrite(AIN1, LOW); //set pin 1 to low
        digitalWrite(AIN2, LOW); //set pin 2 to low
    }
    analogWrite(PWMA, abs(motorSpeed)); //now that the motor direction is set, dri
ve it at the entered speed
}

```

```

/*****/
void leftMotor(int motorSpeed) //function for driving the left motor
{
  if (motorSpeed > 0) //if the motor should drive forward (positive speed)
  {
    digitalWrite(BIN1, HIGH); //set pin 1 to high
    digitalWrite(BIN2, LOW); //set pin 2 to low
  }
  else if (motorSpeed < 0) //if the motor should drive backward (negative speed)
  {
    digitalWrite(BIN1, LOW); //set pin 1 to low
    digitalWrite(BIN2, HIGH); //set pin 2 to high
  }
  else //if the motor should stop
  {
    digitalWrite(BIN1, LOW); //set pin 1 to low
    digitalWrite(BIN2, LOW); //set pin 2 to low
  }
  analogWrite(PWMB, abs(motorSpeed)); //now that the motor direction is set, drive it at the entered speed
}

```

What You Should See

Open the Serial Monitor. It should prompt you to enter a command that contains a direction and distance. When you type a direction and distance into the serial monitor the robot will move or turn.

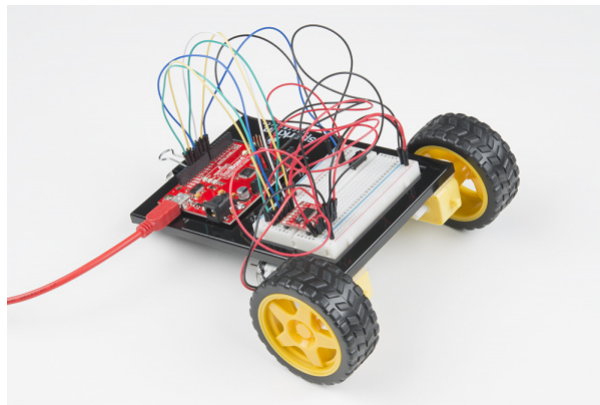

Program Overview

1. Prompt the user to enter a command and list the shortcuts for the directions.
2. Wait for a serial command.
3. Read the first part of the serial command and set that as the direction. Then read the second part of the command and set it as the distance:
 - a. If the direction is "f", drive both motors forward for the distance.
 - b. If the direction is "b", drive both motors backward for the distance.
 - c. If the direction is "r", drive the right motor backward and the left motor forward.
 - d. If the direction is "l", drive the left motor backward and the right motor forward.

Code to Note

Code	Description
Parsing Strings: <code>Serial.readStringUntil(' ');</code>	Reads a serial message until the first space and saves it as a string.
String to Int: <code>string_name.toInt();</code>	If a number is stored in a string variable, this will convert it to an integer, which can be used in math equations.
User Functions	Description
<code>rightMotor(motor_distance);</code>	Drive the right motor long enough to travel the specified distance.
<code>leftMotor(motor_distance);</code>	Drive the left motor long enough to travel the specified distance.

Coding Challenges

Challenge	Description
Replace the switch with a button	Try wiring a button into the circuit instead of the sliding switch. Now the motor only turns on when you push the button!
Replace the switch with a sensor	Try changing the code so that the motor is activated by another sensor, like the photoresistor.

Troubleshooting

Problem	Solution
Motor not spinning	Check the wiring to the motor driver. There are a lot of connections, and it's easy to mix one of them up with another. If only one motor is working, check the wires coming from the non-working motor. Make sure they have not come loose from the motor.
Switch not working	Make sure that you are hooked up to the middle pin and one side pin on the switch.
Still not working?	Jumper wires unfortunately can go "bad" from getting bent too much. The copper wire inside can break, leaving an open connection in your circuit. If you are certain that your circuit is wired correctly and that your code is error-free and uploaded but you are still encountering issues, try replacing one or more of the jumper wires for the component that is not working.

Circuit 5C: Autonomous Robot

Free the robots! In this circuit, you'll unplug your robot and program it to navigate the world on its own. When the robot senses an object using the distance sensor, it will back up and change course.

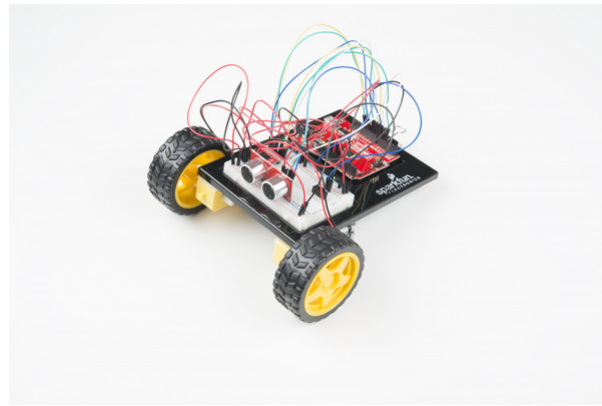

Parts Needed

Grab the following quantities of each part listed to build this circuit:

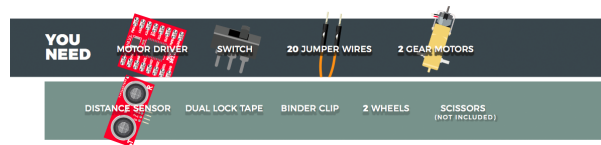

Additional Materials

- Scissors (NOT INCLUDED)
- 4x AA Batteries (NOT INCLUDED)

New Concepts

Autonomous Vehicles

The robot that you will build uses a simple sensor to avoid obstacles. This kind of system is used in Mars rovers, autonomous cars and the bots built for all kinds of robotics competitions. Understanding this example code will set you on the path to building bigger and better autonomous vehicles!

Hardware Hookup

Polarized Components 	Pay special attention to the component's markings indicating how to place it on the breadboard. Polarized components can only be connected to a circuit in one direction.
---	---

Keep in mind that the ultrasonic distance sensor needs a clear path to avoid unwanted interruptions in your robot's movements. Keep the distance sensor clear of any wires from your circuit.

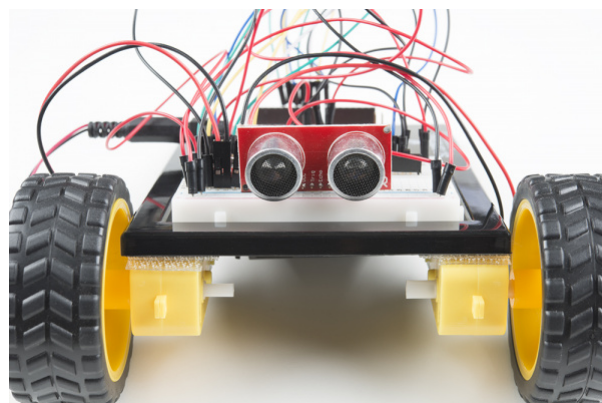

Battery Holder Attachment

It's time to make this robot mobile by adding the battery pack.

If you did not attach the battery pack in Project 4, cut two pieces of Dual Lock that are about 1 inch x 1 inch (2.5cm x 2.5cm) each. Remove the adhesive backing and attach one piece to the back of the battery holder.

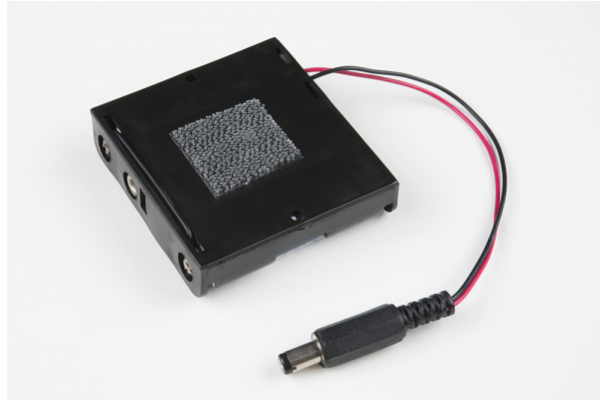

Adhere the second piece to the bottom of the baseplate, directly in the middle.

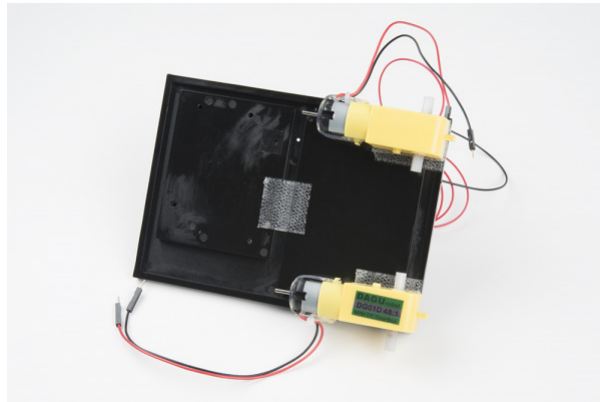

Press the battery holder to the baseplate so that the two pieces of Dual Lock snap together. Insert the batteries into the holder if you have not done so already. Remember that batteries are polarized and can only go in one way.

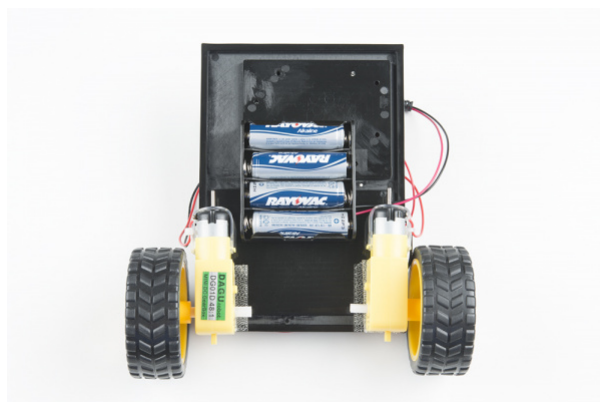

Clip the binder clip back on, and you are ready to roll!

You can choose to remove the motors and battery pack while you build the circuit or leave them on. The choice is yours.

Circuit Diagram

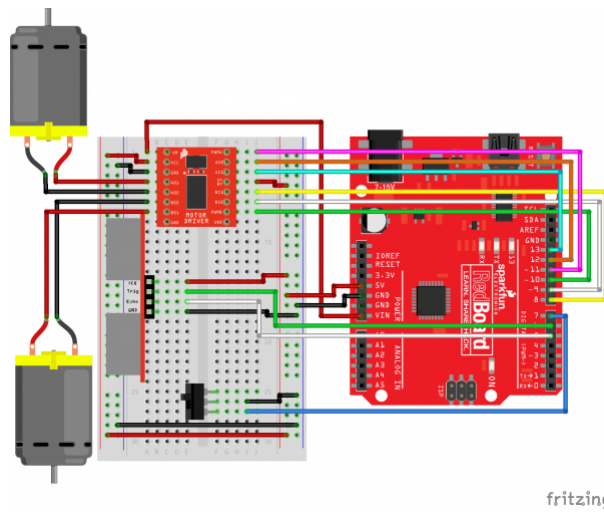

Having a hard time seeing the circuit? [Click on the image for a closer look.](#)

Hookup Table

Component	RedBoard	Breadboard	Breadboard	Breadboard	Breadboard
Jumper Wire	5V	5V Rail (+)			
Jumper Wire	GND	GND Rail (-)			
Jumper Wire		5V Rail (+)	5V Rail (+)		
Jumper Wire		GND Rail (-)	GND Rail (-)		
Jumper Wire	VIN	A1			
Motor Driver ⚠		C1-C8 (VM on C1)	G1-G8 (PWMA on G1)		
Jumper Wire		A2	5V Rail (+)		
Jumper Wire		A3	GND Rail (-)		
Jumper Wire	Digital Pin 8	J5			
Jumper Wire	Digital Pin 9	J6			
Jumper Wire	Digital Pin 10	J7			
Jumper Wire		J4	5V Rail (+)		
Jumper Wire	Digital Pin 11	J1			
Jumper Wire	Digital Pin 12	J2			
Jumper Wire	Digital Pin 13	J3			
Motor 1 (Right) ⚠		A4 (Red +)	A5 (Black -)		

Motor 2 (Left) ⚠		A6 (Black -)	A7 (Red +)		
Switch		F25	F26	F27	
Jumper Wire		I26	GND Rail (-)		
Jumper Wire	Digital Pin 7	I27			
Distance Sensor ⚠		A14 (Vcc)	A15 (Trig)	A16 (Echo)	A17 (GND)
Jumper Wire	Digital Pin 6	E15 (Trig)			
Jumper Wire	Digital Pin 5	E16 (Echo)			
Jumper Wire		E14	5V Rail (+)		
Jumper Wire		E17	GND Rail (-)		

In the table, polarized components are shown with a warning triangle and the **whole row highlighted yellow**.

Open the Sketch

Heads up! Make sure your switch is in the OFF position. As soon as the code is finished uploading, your robot will begin driving. Make sure it cannot drive off a table or other high surface and injure itself.

To open the code, go to: **File > Examples > SIK_Guide_Code-V_4 > SIK_Circuit_5C-AutonomousRobot**

You can also copy and paste the following code into the Arduino IDE. Hit upload, and see what happens!

```

/*
SparkFun Inventor's Kit
Circuit 5C - Autonomous Robot

This robot will drive around on its own and react to obstacles by backing up and turning to a new
direction.
This sketch was adapted from one of the activities in the SparkFun Guide to Arduino.
Check out the rest of the book at
https://www.sparkfun.com/products/14326

This sketch was written by SparkFun Electronics, with lots of help from the Arduino community.
This code is completely free for any use.

View circuit diagram and instructions at: https://learn.sparkfun.com/tutorials/sparkfun-inventor
s-kit-experiment-guide---v40
Download drawings and code at: https://github.com/sparkfun/SIK-Guide-Code
*/

//the right motor will be controlled by the motor A pins on the motor driver
const int AIN1 = 13;           //control pin 1 on the motor driver for the right motor
const int AIN2 = 12;           //control pin 2 on the motor driver for the right motor
const int PWMA = 11;           //speed control pin on the motor driver for the right motor

//the left motor will be controlled by the motor B pins on the motor driver
const int PWMB = 10;           //speed control pin on the motor driver for the left motor
const int BIN2 = 9;            //control pin 2 on the motor driver for the left motor
const int BIN1 = 8;            //control pin 1 on the motor driver for the left motor

//distance variables
const int trigPin = 6;
const int echoPin = 5;

int switchPin = 7;             //switch to turn the robot on and off

float distance = 0;            //variable to store the distance measured by the distance sensor

//robot behaviour variables
int backupTime = 300;          //amount of time that the robot will back up when it senses an o
bject
int turnTime = 200;           //amount that the robot will turn once it has backed up

/*****/
void setup()
{
  pinMode(trigPin, OUTPUT);     //this pin will send ultrasonic pulses out from the distance s
ensor
  pinMode(echoPin, INPUT);      //this pin will sense when the pulses reflect back to the dist
ance sensor

  pinMode(switchPin, INPUT_PULLUP); //set this as a pullup to sense whether the switch is flip

```

ped

```
//set the motor contro pins as outputs
pinMode(AIN1, OUTPUT);
pinMode(AIN2, OUTPUT);
pinMode(PWMA, OUTPUT);

pinMode(BIN1, OUTPUT);
pinMode(BIN2, OUTPUT);
pinMode(PWMB, OUTPUT);

Serial.begin(9600);          //begin serial communication with the computer
Serial.print("To infinity and beyond!"); //test the serial connection
}

/*****
void loop()
{
  //DETECT THE DISTANCE READ BY THE DISTANCE SENSOR
  distance = getDistance();

  Serial.print("Distance: ");
  Serial.print(distance);
  Serial.println(" in");          // print the units

  if(digitalRead(switchPin) == LOW){ //if the on switch is flipped

    if(distance < 10){           //if an object is detected
      //back up and turn
      Serial.print(" ");
      Serial.print("BACK!");

      //stop for a moment
      rightMotor(0);
      leftMotor(0);
      delay(200);

      //back up
      rightMotor(-255);
      leftMotor(-255);
      delay(backupTime);

      //turn away from obsticle
      rightMotor(255);
      leftMotor(-255);
      delay(turnTime);

    }else{                       //if no obstacle is detected drive forward
      Serial.print(" ");
      Serial.print("Moving...");

      rightMotor(255);
```

```

    leftMotor(255);
}
} else{                                     //if the switch is off then stop

    //stop the motors
    rightMotor(0);
    leftMotor(0);
}

delay(50);                                 //wait 50 milliseconds between readings
}

/*****/
void rightMotor(int motorSpeed)             //function for driving the right motor
{
    if (motorSpeed > 0)                     //if the motor should drive forward (posit
ive speed)
    {
        digitalWrite(AIN1, HIGH);          //set pin 1 to high
        digitalWrite(AIN2, LOW);           //set pin 2 to low
    }
    else if (motorSpeed < 0)                //if the motor should drive backwar (negat
ive speed)
    {
        digitalWrite(AIN1, LOW);           //set pin 1 to low
        digitalWrite(AIN2, HIGH);          //set pin 2 to high
    }
    else                                    //if the motor should stop
    {
        digitalWrite(AIN1, LOW);           //set pin 1 to low
        digitalWrite(AIN2, LOW);           //set pin 2 to low
    }
    analogWrite(PWMA, abs(motorSpeed));     //now that the motor direction is set, dri
ve it at the entered speed
}

/*****/
void leftMotor(int motorSpeed)              //function for driving the left motor
{
    if (motorSpeed > 0)                     //if the motor should drive forward (posit
ive speed)
    {
        digitalWrite(BIN1, HIGH);         //set pin 1 to high
        digitalWrite(BIN2, LOW);           //set pin 2 to low
    }
    else if (motorSpeed < 0)                //if the motor should drive backwar (negat
ive speed)
    {
        digitalWrite(BIN1, LOW);           //set pin 1 to low
        digitalWrite(BIN2, HIGH);          //set pin 2 to high
    }
    else                                    //if the motor should stop
    {
        digitalWrite(BIN1, LOW);           //set pin 1 to low

```



```

    digitalWrite(BIN2, LOW);           //set pin 2 to low
  }
  analogWrite(PWMB, abs(motorSpeed)); //now that the motor direction is set, dri
ve it at the entered speed
}

/*****
//RETURNS THE DISTANCE MEASURED BY THE HC-SR04 DISTANCE SENSOR
float getDistance()
{
  float echoTime;           //variable to store the time it takes for a ping to bounce o
ff an object
  float calcualtedDistance; //variable to store the distance calculated from the echo ti
me

  //send out an ultrasonic pulse that's 10ms long
  digitalWrite(trigPin, HIGH);
  delayMicroseconds(10);
  digitalWrite(trigPin, LOW);

  echoTime = pulseIn(echoPin, HIGH); //use the pulsein command to see how long it takes for the
pulse to bounce back to the sensor

  calcualtedDistance = echoTime / 148.0; //calculate the distance of the object that reflected
the pulse (half the bounce time multiplied by the speed of sound)

  return calcualtedDistance; //send back the distance that was calculated
}

```

What You Should See:

When the switch is turned off, the robot will sit still. When the switch is turned on, the robot will drive forward until it senses an object.

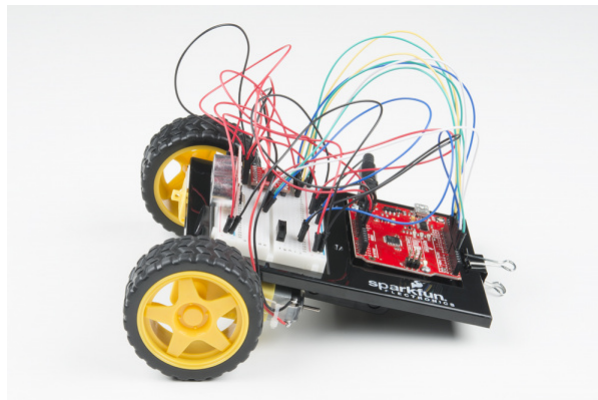

When it does, it will stop, back up and turn to the right before driving forward again.

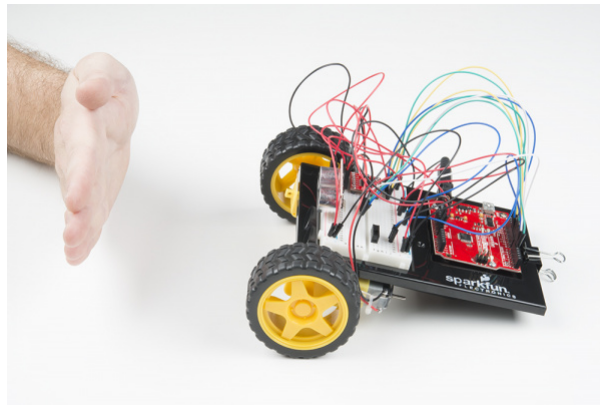

Troubleshooting Warning: HVAC systems in offices and schools have been known to interfere with the performance of the ultrasonic distance sensor. If you are experiencing sporadic behavior from your circuit, check your surroundings. If there are numerous air ducts in the room you are using, try moving to a different room that does not have ducts. The airflow from these ducts can interfere with the waves sent from the sensor, creating noise and resulting in bad readings.

Program Overview

1. If the switch is turned on,
2. Then start sensing the distance.
 - a. If no obstacle is detected, then drive forward.
 - b. If an obstacle is detected, stop, back up, and turn right.
 - c. If no obstacle is detected, start driving forward again.

Code to Note

This code builds upon all the concepts you've learn in all the previous projects. There are no new functions or objects.

Coding Challenges

Challenge	Description
Change the distance at which your robot reacts	Try changing the distance at which your robot stops and turns away from an obstacle.
Change the behavior of the robot when it senses an obstacle	Try changing the code so that your robot does something different when it senses an obstacle.

Troubleshooting

Problem	Solution
---------	----------

The robot drives backward and/or turns in the wrong direction	Check the wiring of your motors and the way that they are mounted to the breadboard and Arduino holder. If one of your motors is flipped around, reposition it, or switch its black and red wires on the breadboard (this will reverse the direction that it turns).
The robot runs into obstacles	You can try gently bending the pins of the distance sensor so that it points farther up, away from the floor. The robot will get stuck if one wheel hits an object that it is driving past (the distance sensor won't see the obstacle unless it's in front of the robot).
The robot drives backward and turns when there are no obstacles	Make sure the wires are not in front of the distance sensor. Also make sure you are not in a room with large HVAC vents. As in Project 3, these vents can wreak havoc on the ultrasonic distance sensor.
The robot drives slow or not at all, though the RedBoard is powered	If your board is powered but the robot is slow, won't move at all, or is behaving sporadically, check the batteries. These behaviors are symptoms of low or dead batteries.
Still not working?	Jumper wires unfortunately can go "bad" from getting bent too much. The copper wire inside can break, leaving an open connection in your circuit. If you are certain that your circuit is wired correctly and that your code is error-free and uploaded but you are still encountering issues, try replacing one or more of the jumper wires for the component that is not working.

Resources and Going Further

There are tons of sensors and shields you can hookup to an Arduino that will help take your projects to the next level. Here's some further reading that may help you along in learning more about the world of electronics.

For more inspiration and ideas for working with your SIK, check out these tutorials:

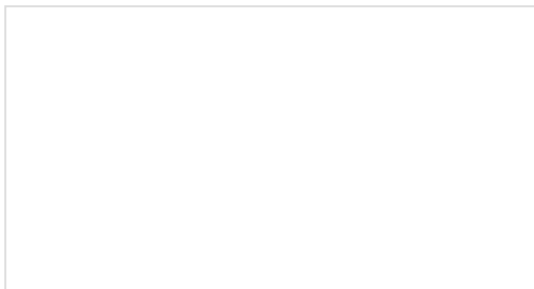

SIK Keyboard Instrument

We can use the parts and concepts in the SparkFun Inventor's Kit to make a primitive keyboard instrument.

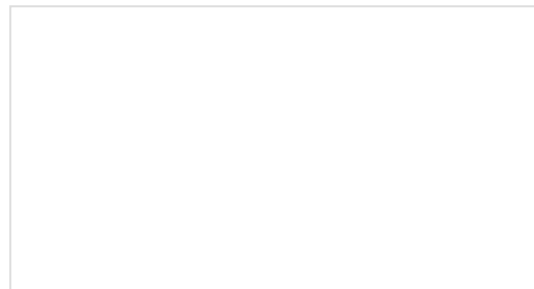

Measuring Internal Resistance of Batteries

Classroom STEM activity that has students build a battery from a lemon, measure the open and closed

circuit voltages, and determine the battery's internal resistance.

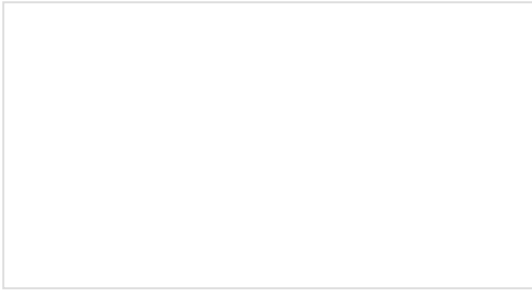

Light-Seeking Robot

We use parts from the SparkFun Inventor's Kit v4.0 to create a light-seeking robot that mimics the behavior of single-celled organisms.

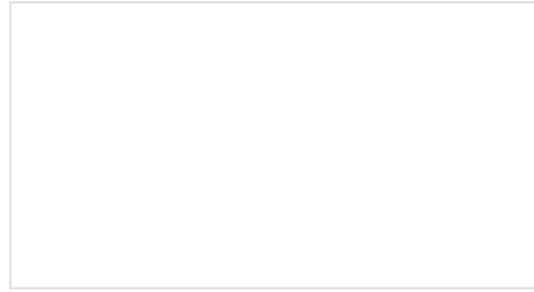

Clap On Lamp

Modify a simple desk lamp to respond to a double clap (or other sharp noise) using parts from the SparkFun Inventor's Kit v4.0.

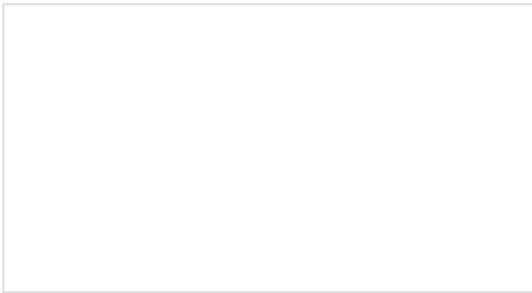

Endless Runner Game

We make a simple side-scrolling endless runner game using parts from the SparkFun Inventor's Kit v4.0.

For more info on Arduino, check out these tutorials:

- [Arduino Resources and Curriculum](#)
- [Arduino Comparison Guide](#)
- [Arduino Shields](#)
- [Installing Arduino](#)
- [Installing an Arduino Library](#)
- [Arduino Data Types](#)

For more hardware related tutorials, give these a read:

- [Breadboards](#)
 - [Working with Wire](#)
 - [Sewing with conductive thread](#)
 - [How do I power my project?](#)
-

We also have additional kits available that cover different microcontrollers, development environments, and robotics.



Raspberry Pi 3 Starter Kit

🕒 KIT-13826



SparkFun Inventor's Kit for RedBot

🕒 ROB-12649



SparkFun Inventor's Kit for Photon

🕒 KIT-13320



Johnny-Five Inventor's Kit

🕒 KIT-13847



SparkFun Inventor's Kit for MicroView

🕒 KIT-13205



SparkFun Inventor's Kit for LabVIEW

🕒 KIT-13271

★★★★☆ 7 Retired



SparkFun Inventor's Kit for Intel® Edison

🚫 KIT-13742

★★★★☆ 2 Retired



mbed Starter Kit

🚫 KIT-12968

★★★★★ 4 Retired

Reference files are available here:

- [Example code on GitHub](#)
- [Fritzing diagrams on GitHub](#)
- [PDF version of the Guide](#)
- [SIK Projects code on GitHub](#)

Thanks for following along!