

Pentaband Dipole Antenna TNC Spin Connector

806-960/1710-2170 MHz, 0.5 dBi. Pulse Part Number: SPDA17806/2170



Electrical Specifications

Frequency	806-960/ 1710-2170 MHz	
Nominal Impedance [Ω]	50	
VSWR	2.5:1 Max	
Gain (806-960)	0 dBi ± .5 dB	
Gain (825-900)	.5 dBi ± .5 dB	
Gain (1710-2170)	.5 dBi ± .5 dB	
Radiation Pattern, 3 dB Beamwidth	Horizontal Plane	Omni
	Vertical Plane (849)	88 ° ± 2 °
	Vertical Plane (960)	58 ° ± 2 °
	Vertical Plane (1747)	80 ° ± 2 °
	Vertical Plane (1850)	48 ° ± 2 °
	Vertical Plane (1950)	45 ° ± 2 °
	Vertical Plane (2140):	55 ° ± 2 °
Polarization	Vertical	
Power Withstanding [W]	25	
Connector Type	TNC (Male)	

Mechanical and Environmental Specifications

Plastic radome	Flammability Rating	Color	Weight [g]	Overall Length [inches]	Operating Temperature [°C]	Storage Temperature [°C]
PC/ABS	UL94 V-0	Gray	36	7.56	-30 to +70	-40 to +85

Pulse Finland Oy

Takatie 6
90440 Kempele, Finland
Tel: +358 207 935 500
Fax: +358 207 935 501
www.pulseeng.com/antennas



Pentaband Dipole Antenna TNC Spin Connector

806-960/1710-2170 MHz, 0.5 dBi. Pulse Part Number: SPDA17806/2170

Curves

VSWR

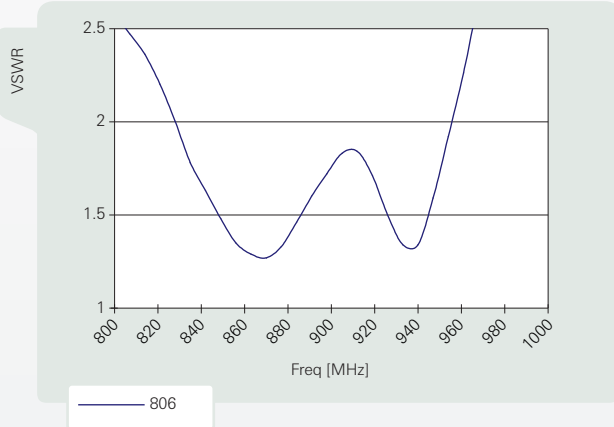

VSWR

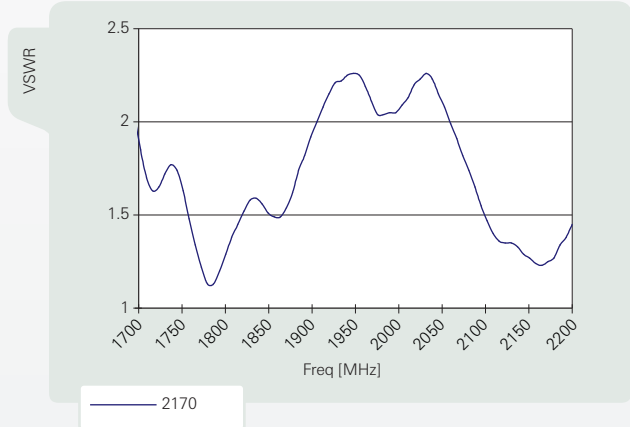

849 MHz

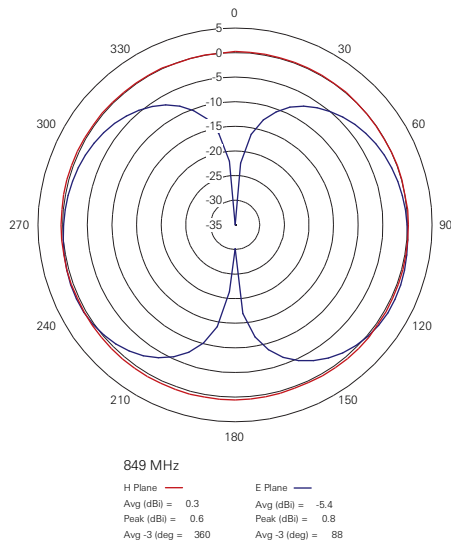

960 MHz

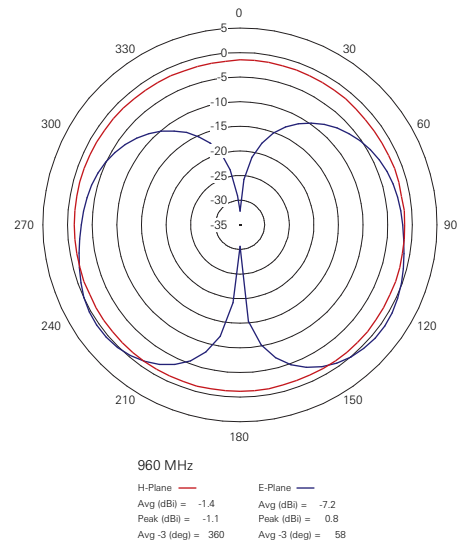

Pulse Finland Oy

Takatie 6
90440 Kempele, Finland
Tel: +358 207 935 500
Fax: +358 207 935 501

www.pulseeng.com/antennas



Pentaband Dipole Antenna TNC Spin Connector

806-960/1710-2170 MHz, 0.5 dBi. Pulse Part Number: SPDA17806/2170

Curves

1747 MHz

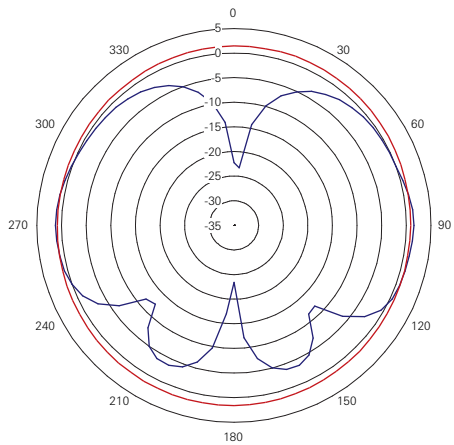

1747 MHz

H-Plane —	E-Plane —
Avg (dBi) = 1.2	Avg (dBi) = -4.4
Peak (dBi) = 1.6	Peak (dBi) = 1.5
Avg -3 (deg) = 360	Avg -3 (deg) = 80

1850 MHz

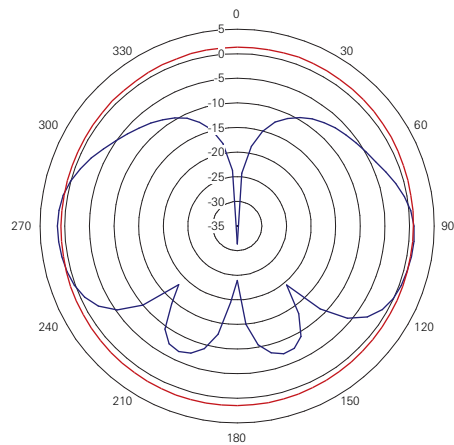

1850 MHz

H-Plane —	E-Plane —
Avg (dBi) = 1.1	Avg (dBi) = -7.7
Peak (dBi) = 1.5	Peak (dBi) = 1.5
Avg -3 (deg) = 360	Avg -3 (deg) = 48

1950 MHz

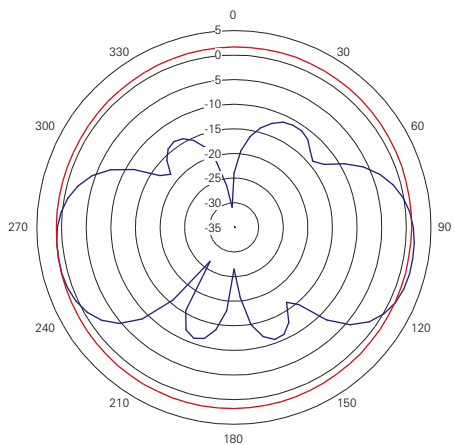

1950 MHz

H-Plane —	E-Plane —
Avg (dBi) = 1.4	Avg (dBi) = -9.7
Peak (dBi) = 1.9	Peak (dBi) = 1.9
Avg -3 (deg) = 360	Avg -3 (deg) = 45

2140 MHz

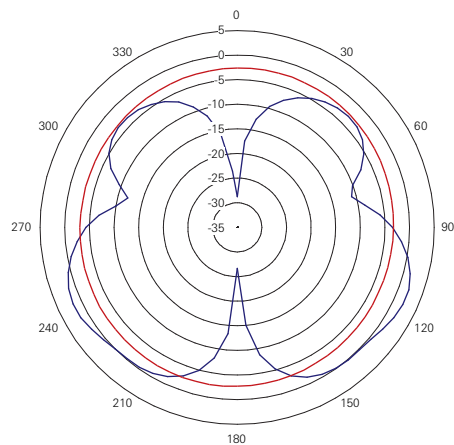

2140MHz

H-Plane —	E-Plane —
Avg (dBi) = -2.9	Avg (dBi) = -5.3
Peak (dBi) = -2.5	Peak (dBi) = 2.1
Avg -3 (deg) = 360	Avg -3 (deg) = 55

Pulse Finland Oy

Takatie 6
90440 Kempele, Finland
Tel: +358 207 935 500
Fax: +358 207 935 501
www.pulseeng.com/antennas



Pentaband Dipole Antenna TNC Spin Connector

806-960/1710-2170 MHz, 0.5 dBi. Pulse Part Number: SPDA17806/2170

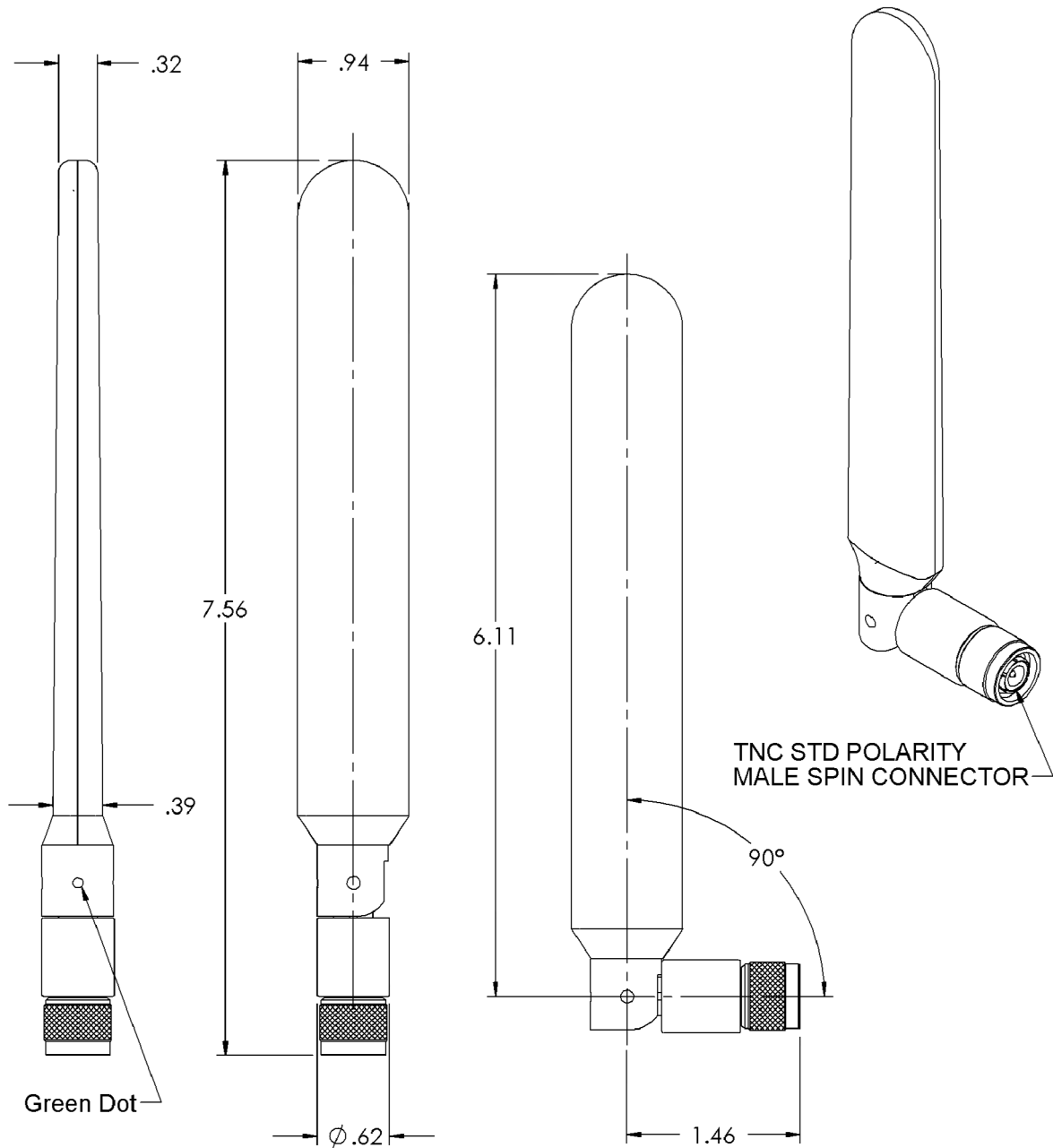

Pulse Finland Oy

Takatie 6
90440 Kempele, Finland

Tel: +358 207 935 500

Fax: +358 207 935 501

www.pulseeng.com/antennas

