

Features

- GaN Depletion Mode HEMT Microwave Transistor
- Common Source Configuration
- Broadband Class AB Operation
- Thermally Enhanced Cu/Mo/Cu Package
- RoHS Compliant
- +50 V Typical Operation
- MTTF of 600 Years ($T_J < 200^\circ\text{C}$)
- EAR99 Export Classification

Applications

- Civilian and Military Pulsed Radar

Description

The MAGX-002731-180L00 and MAGX-002731-180LOS are gold metalized matched Gallium Nitride (GaN) on Silicon Carbide RF power transistors optimized for civilian and military radar pulsed applications between 2700 - 3100 MHz.

Using state of the art wafer fabrication processes, these high performance transistors provide high gain, efficiency, bandwidth, ruggedness over a wide bandwidth for today's demanding application needs.

The MAGX-002731-180L00 and MAGX-002731-180LOS are constructed using thermally enhanced Cu/Mo/Cu flanged ceramic packages which provide excellent thermal performance. High breakdown voltages allow for reliable and stable operation in extreme mismatched load conditions unparalleled with older semiconductor technologies.

MAGX-002731-180L00



MAGX-002731-180LOS



Ordering Information¹

Part Number	Package
MAGX-002731-180L00	Standard Flange
MAGX-002731-180LOS	Earless Flange
MAGX-S32731-180L00	2700 – 3100 MHz Evaluation Board

1. When ordering the evaluation board, please indicate on sales order notes if it will be used for:
 - A. Standard Flange devices
 - B. Earless Flange devices

GaN on SiC HEMT Pulsed Power Transistor
180 W Peak, 2700 to 3100 MHz, 300 μ s Pulse, 10% Duty

Rev. V6

Electrical Specifications²: 2700 - 3100 MHz, $T_A = 25^\circ\text{C}$

Parameter	Test Conditions	Symbol	Min.	Typ.	Max.	Units
RF Functional Tests: $V_{DD} = 50\text{ V}$, $I_{DQ} = 500\text{ mA}$, 300 μs Pulse, 10% Duty Cycle						
Output Power	$P_{IN} = 14\text{ Wpk}$	P_{OUT}	180	215	-	Wpk
Gain	$P_{IN} = 14\text{ Wpk}$	G_P	11.1	11.8	-	dB
Drain Efficiency	$P_{IN} = 14\text{ Wpk}$	η_D	43	51	-	%
Load Mismatch Stability	$P_{IN} = 14\text{ Wpk}$	VSWR-S	-	5:1	-	-
Load Mismatch Tolerance	$P_{IN} = 14\text{ Wpk}$	VSWR-T	-	10:1	-	-

2. Typical RF performance measured in an RF evaluation board.

Electrical Characteristics: $T_A = 25^\circ\text{C}$

Parameter	Test Conditions	Symbol	Min.	Typ.	Max.	Units
DC Characteristics						
Drain-Source Leakage Current	$V_{GS} = -8\text{ V}$, $V_{DS} = 175\text{ V}$	I_{DS}	-	-	12	mA
Gate Threshold Voltage	$V_{DS} = 5\text{ V}$, $I_D = 30\text{ mA}$	$V_{GS(TH)}$	-5	-3	-2	V
Forward Transconductance	$V_{DS} = 5\text{ V}$, $I_D = 3.5\text{ mA}$	G_M	5	-	-	S
Dynamic Characteristics						
Input Capacitance	N/A - Input Internally Matched	C_{ISS}	N/A	N/A	N/A	pF
Output Capacitance	$V_{DS} = 50\text{ V}$, $V_{GS} = -8\text{ V}$, $F = 1\text{ MHz}$	C_{OSS}	-	26.1	30.3	pF
Reverse Transfer Capacitance	$V_{DS} = 50\text{ V}$, $V_{GS} = -8\text{ V}$, $F = 1\text{ MHz}$	C_{RSS}	-	2.3	4.7	pF

Absolute Maximum Ratings^{3,4,5}

Parameter	Absolute Maximum
Drain Supply Voltage (V_{DD})	+65 V
Gate Supply Voltage (V_{GG})	-8 V to 0 V
Drain Supply Current (I_D)	10 A
Input Power ⁶ (P_{IN})	P_{IN} (nominal) + 3 dB
Operating Junction Temperature ⁷	250°C
Peak Pulsed Power Dissipation @ 85°C	192 W
Operating Temperature	-40°C to +85°C
Storage Temperature	-65°C to +150°C
ESD Min. - Charged Device Model (CDM)	350 V
ESD Min. - Human Body Model (HBM)	550 V
Maximum Solder Temperature	260°C

3. Exceeding any one or combination of these limits may cause permanent damage to this device.

4. MACOM does not recommend sustained operation near these survivability limits.

5. For saturated performance it is recommended that the sum of $(3 * V_{DD} + |V_{GG}|) < 175$ V.

6. Input Power Limit is +3 dB over nominal drive required to achieve $P_{OUT} = 180$ W.

7. Operating junction temperature is measured with infrared (IR) microscope. Junction temperature directly affects a device's MTTF and should be kept as low as possible to maximize lifetime.

- MTTF = 5.3×10^6 hours ($T_J < 200^\circ\text{C}$)
- MTTF = 6.8×10^4 hours ($T_J < 250^\circ\text{C}$)

Thermal Characteristics

Parameter	Test Conditions	Symbol	Typical	Units
Thermal Resistance	$T_C = 85^\circ\text{C}$, $V_{DD} = 50$ V, $I_{DQ} = 500$ mA Pulse Width = 500 μ s, Duty Cycle = 10%	Θ_{JC}	0.6	$^\circ\text{C/W}$

Test Fixture Assembly

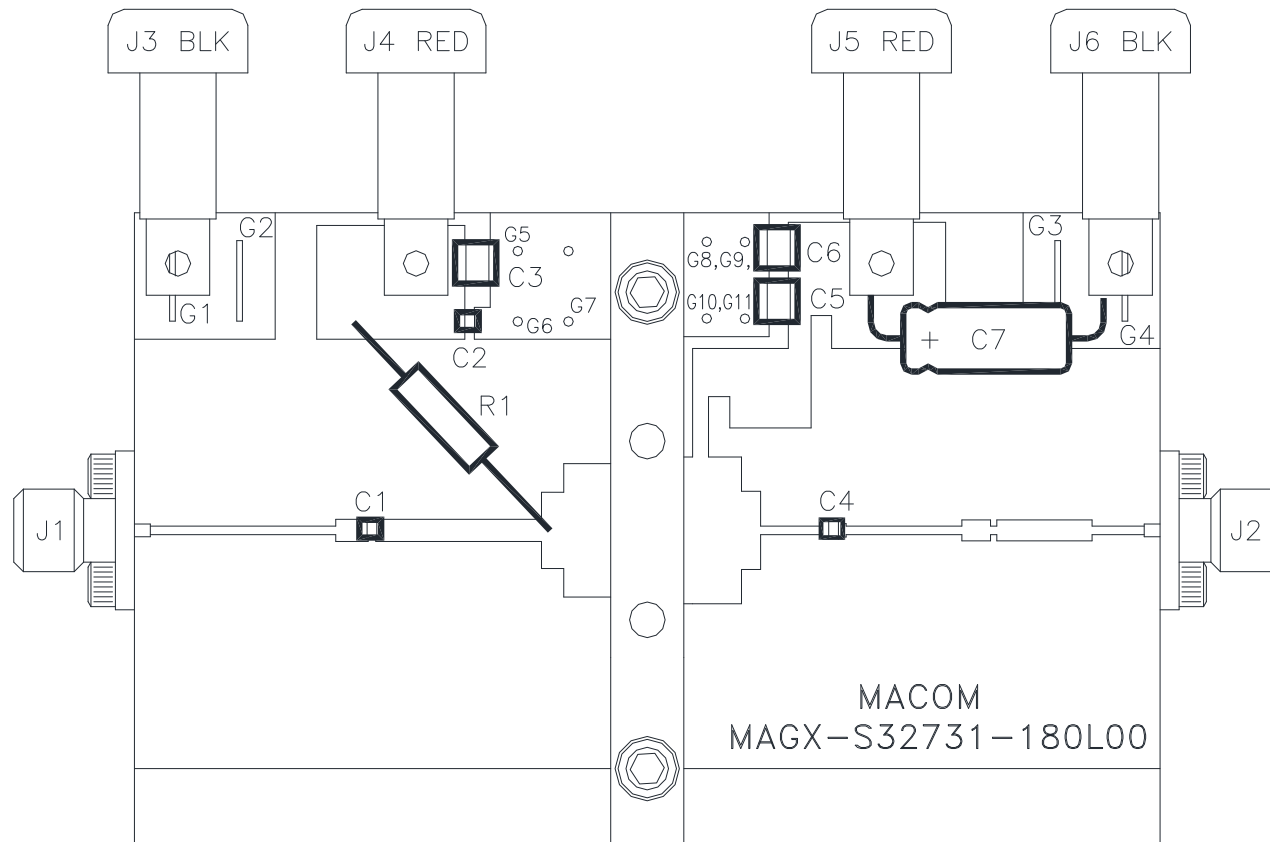

Parts List

Part	Description
C1, C2, C4	Capacitor, 12 pF, 250 V, 5%, ATC800A
C3, C5	Capacitor, 0.1 μ F, 100 V, 10%, X7R, 0805, TDK
C6	Capacitor, 1.0 μ F, 100 V, 5%, 1206, Murata
C7	Capacitor, 22 μ F, 100 V, 20%, Panasonic
R1	Resistor, 12 ohm, 1/4 W, 1%, Axial, Vishay Dale
J1, J2	SMA Connector
J3, J6	Female Banana Jack, Black
J4, J5	Female Banana Jack, Red
PCB	MACOM (Rogers RT6010.5LM, 0.25" thick, Er = 10.5)

Applications Section

Typical Large-Signal Performance Curves

2700 - 3100 MHz, 300 μ s Pulse, 10% Duty Cycle, $V_{DD} = 50$ V, $I_{DQ} = 500$ mA, $P_{IN} = 14$ Wpk, $T_A = 25^\circ\text{C}$

Output Power vs. Input Power

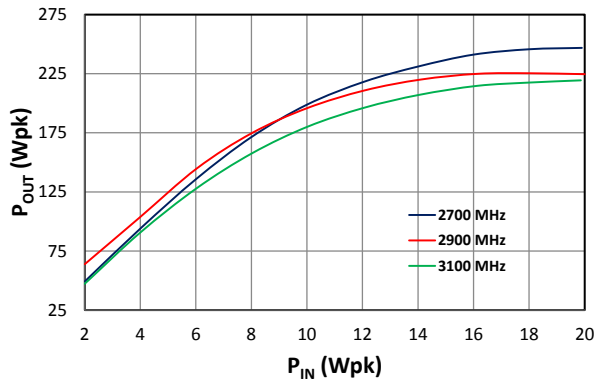

Drain Efficiency vs. Output Power

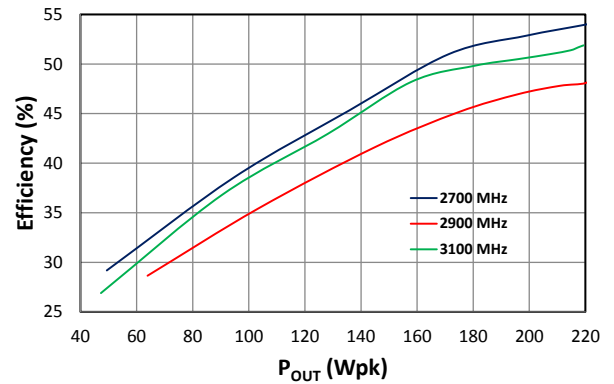

Gain vs. Output Power

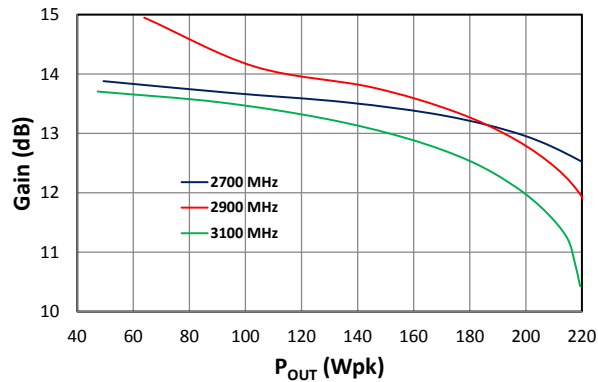

Applications Section

Typical Large-Signal Performance Curves

2700 - 3100 MHz, 500 μ s Pulse, 10% Duty Cycle, $V_{DD} = 50$ V, $I_{DQ} = 500$ mA, $P_{IN} = 14$ Wpk, $T_A = 25^\circ\text{C}$

Output Power vs. Input Power

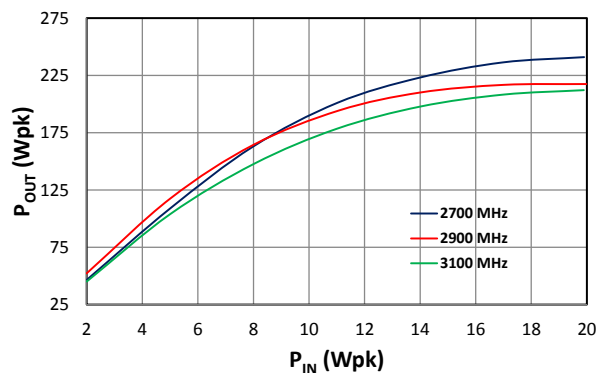

Drain Efficiency vs. Output Power

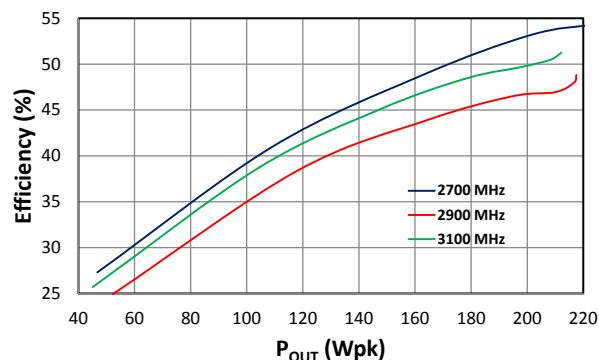

Gain vs. Output Power

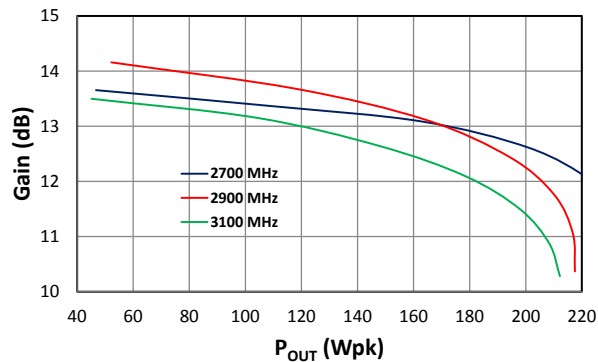

Outline Drawing (Flanged)

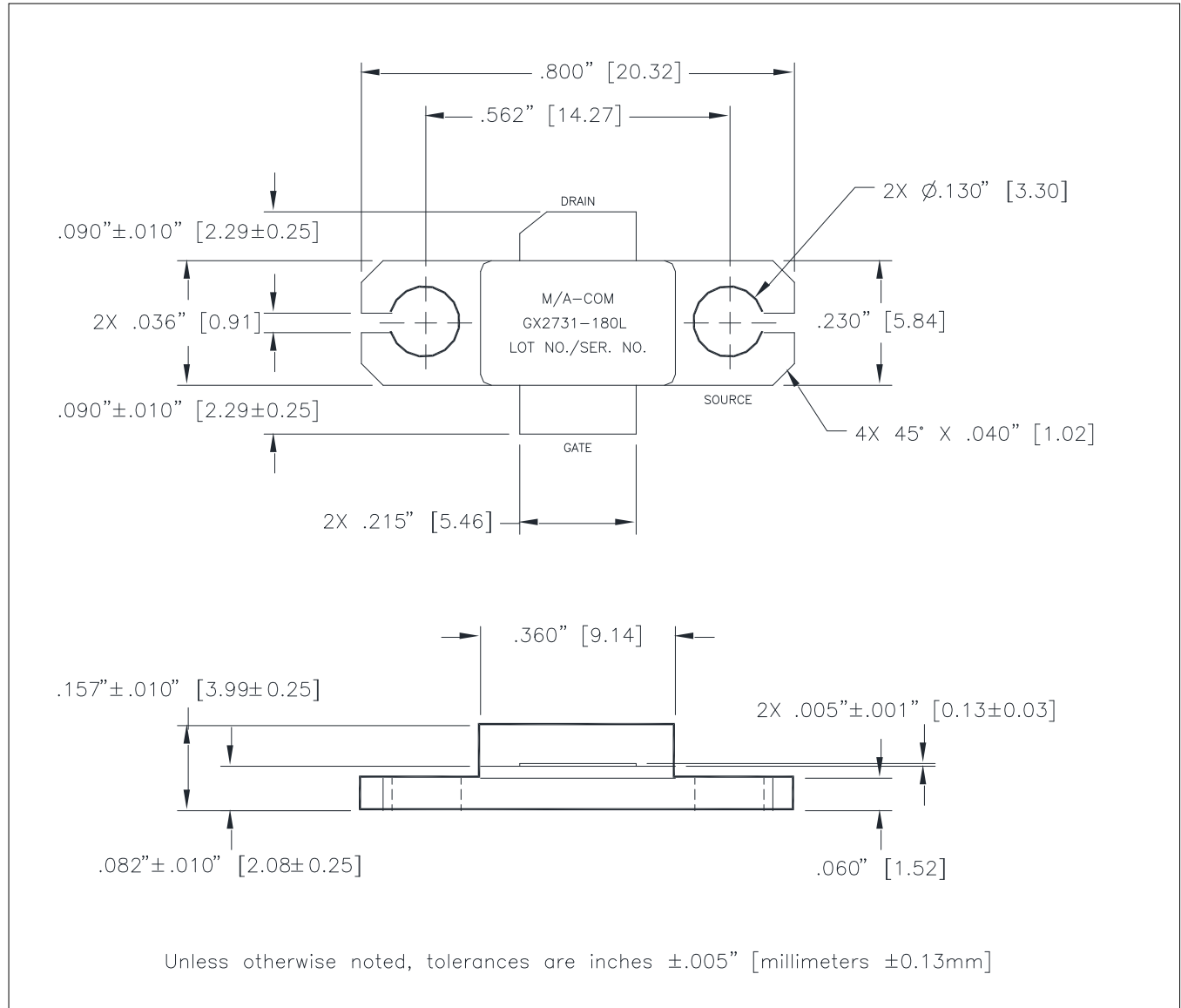

Bias Sequencing

TURNING THE DEVICE ON

1. Set V_{GS} to the pinch-off (V_P), typically -5 V.
2. Turn on V_{DS} to nominal voltage (50 V).
3. Increase V_{GS} until the I_{DS} current is reached.
4. Apply RF power to desired level.

TURNING THE DEVICE OFF

1. Turn the RF power off.
2. Decrease V_{GS} down to V_P .
3. Decrease V_{DS} down to 0 V.
4. Turn off V_{GS} .

Outline Drawing (Flangeless)

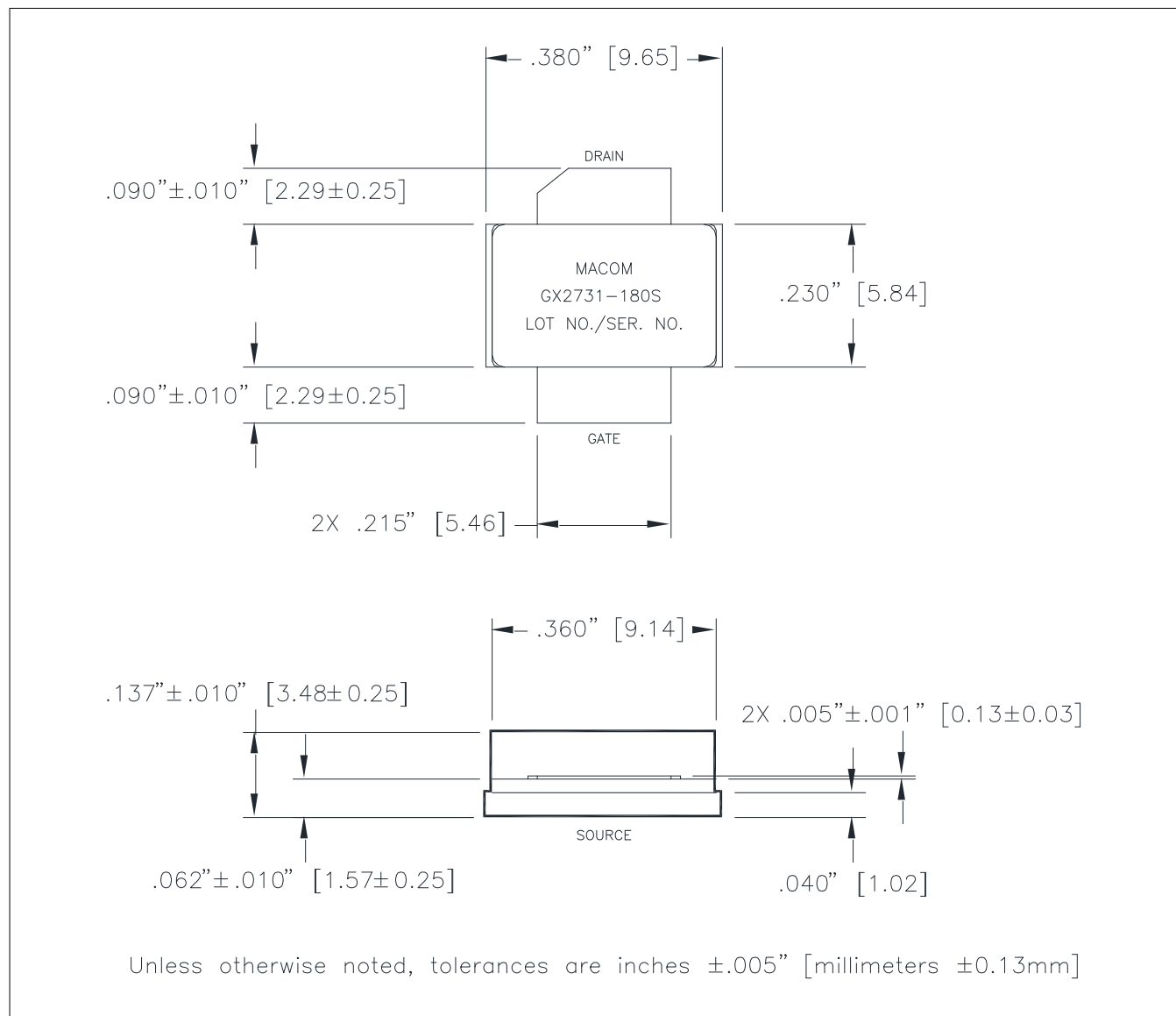

M/A-COM Technology Solutions Inc. All rights reserved.

Information in this document is provided in connection with M/A-COM Technology Solutions Inc ("MACOM") products. These materials are provided by MACOM as a service to its customers and may be used for informational purposes only. Except as provided in MACOM's Terms and Conditions of Sale for such products or in any separate agreement related to this document, MACOM assumes no liability whatsoever. MACOM assumes no responsibility for errors or omissions in these materials. MACOM may make changes to specifications and product descriptions at any time, without notice. MACOM makes no commitment to update the information and shall have no responsibility whatsoever for conflicts or incompatibilities arising from future changes to its specifications and product descriptions. No license, express or implied, by estoppel or otherwise, to any intellectual property rights is granted by this document.

THESE MATERIALS ARE PROVIDED "AS IS" WITHOUT WARRANTY OF ANY KIND, EITHER EXPRESS OR IMPLIED, RELATING TO SALE AND/OR USE OF MACOM PRODUCTS INCLUDING LIABILITY OR WARRANTIES RELATING TO FITNESS FOR A PARTICULAR PURPOSE, CONSEQUENTIAL OR INCIDENTAL DAMAGES, MERCHANTABILITY, OR INFRINGEMENT OF ANY PATENT, COPYRIGHT OR OTHER INTELLECTUAL PROPERTY RIGHT. MACOM FURTHER DOES NOT WARRANT THE ACCURACY OR COMPLETENESS OF THE INFORMATION, TEXT, GRAPHICS OR OTHER ITEMS CONTAINED WITHIN THESE MATERIALS. MACOM SHALL NOT BE LIABLE FOR ANY SPECIAL, INDIRECT, INCIDENTAL, OR CONSEQUENTIAL DAMAGES, INCLUDING WITHOUT LIMITATION, LOST REVENUES OR LOST PROFITS, WHICH MAY RESULT FROM THE USE OF THESE MATERIALS.

MACOM products are not intended for use in medical, lifesaving or life sustaining applications. MACOM customers using or selling MACOM products for use in such applications do so at their own risk and agree to fully indemnify MACOM for any damages resulting from such improper use or sale.