

Features

- Advanced Process Technology
- Optimized for Motor Drive, DC-DC and other Heavy Load Applications
- Exceptionally Small Footprint and Low Profile
- High Power Density
- Low Parasitic Parameters
- Dual Sided Cooling
- Repetitive Avalanche Capability for Robustness and Reliability
- Lead free, RoHS Compliant and Halogen free

$V_{(BR)DSS}$	40V
$R_{DS(on)}$ typ.	1.2mΩ
	max.
I_D (Silicon Limited)	184A
Q_g	129nC

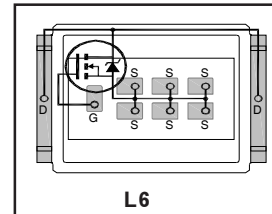

Applicable DirectFET® Outline and Substrate Outline ①

SB	SC			M2	M4		L4	L6	L8	
-----------	-----------	--	--	-----------	-----------	--	-----------	-----------	-----------	--

Description

The IRF7738L2TR(1)PbF combines the latest HEXFET® Power MOSFET Silicon technology with the advanced DirectFET® packaging to achieve the lowest on-state resistance in a package that has the footprint of a DPak (TO-252AA) and only 0.7 mm profile. The DirectFET package is compatible with existing layout geometries used in power applications, PCB assembly equipment and vapor phase, infra-red or convection soldering techniques, when application note AN-1035 is followed regarding the manufacturing methods and processes. The DirectFET package allows dual sided cooling to maximize thermal transfer.

This HEXFET® Power MOSFET is designed for applications where efficiency and power density are essential. The advanced DirectFET® packaging platform coupled with the latest silicon technology allows the IRF7738L2TR(1)PbF to offer substantial system level savings and performance improvement specifically in motor drive, high frequency DC-DC and other heavy load applications. This MOSFET utilizes the latest processing techniques to achieve low on-resistance and low Q_g per silicon area. Additional features of this MOSFET are 175°C operating junction temperature and high repetitive peak current capability. These features combine to make this MOSFET a highly efficient, robust and reliable device for high current applications.

Absolute Maximum Ratings

Stresses beyond those listed under "Absolute Maximum Ratings" may cause permanent damage to the device. These are stress ratings only; and functional operation of the device at these or any other condition beyond those indicated in the specifications is not implied. Exposure to absolute-maximum-rated conditions for extended periods may affect device reliability. The thermal resistance and power dissipation ratings are measured under board mounted and still air conditions. Ambient temperature (T_A) is 25°C, unless otherwise specified.

	Parameter	Max.	Units
V_{DS}	Drain-to-Source Voltage	40	V
V_{GS}	Gate-to-Source Voltage	± 20	
$I_D @ T_C = 25^\circ C$	Continuous Drain Current, $V_{GS} @ 10V$ (Silicon Limited)④	184	A
$I_D @ T_C = 100^\circ C$	Continuous Drain Current, $V_{GS} @ 10V$ (Silicon Limited)④	130	
$I_D @ T_A = 25^\circ C$	Continuous Drain Current, $V_{GS} @ 10V$ (Silicon Limited)③	35	
$I_D @ T_C = 25^\circ C$	Continuous Drain Current, $V_{GS} @ 10V$ (Package Limited)	315	
I_{DM}	Pulsed Drain Current ⑤	736	
$P_D @ T_C = 25^\circ C$	Power Dissipation ④	94	W
$P_D @ T_A = 25^\circ C$	Power Dissipation ③	3.3	
E_{AS}	Single Pulse Avalanche Energy (Thermally Limited) ⑥	134	mJ
E_{AS} (tested)	Single Pulse Avalanche Energy Tested Value ⑥	538	
I_{AR}	Avalanche Current ⑤	See Fig. 18a, 18b, 16, 17	A
E_{AR}	Repetitive Avalanche Energy ⑤		mJ
T_P	Peak Soldering Temperature	270	°C
T_J	Operating Junction and	-55 to + 175	
T_{STG}	Storage Temperature Range		

Thermal Resistance

	Parameter	Typ.	Max.	Units
$R_{\theta JA}$	Junction-to-Ambient ③	—	45	°C/W
$R_{\theta JA}$	Junction-to-Ambient ⑥	12.5	—	
$R_{\theta JA}$	Junction-to-Ambient ⑥	20	—	
$R_{\theta JCan}$	Junction-to-Can ④⑥	—	1.6	
$R_{\theta J-PCB}$	Junction-to-PCB Mounted	—	0.5	
	Linear Derating Factor ④	0.63		W/°C

HEXFET® is a registered trademark of International Rectifier.

Static Characteristics @ $T_J = 25^\circ\text{C}$ (unless otherwise stated)

	Parameter	Min.	Typ.	Max.	Units	Conditions
$V_{(BR)DSS}$	Drain-to-Source Breakdown Voltage	40	—	—	V	$V_{GS} = 0V, I_D = 250\mu A$
$\Delta V_{(BR)DSS}/\Delta T_J$	Breakdown Voltage Temp. Coefficient	—	0.02	—	V/ $^\circ\text{C}$	Reference to $25^\circ\text{C}, I_D = 1\text{mA}$
$R_{DS(on)}$	Static Drain-to-Source On-Resistance	—	1.2	1.6	m Ω	$V_{GS} = 10V, I_D = 109A$ ②
$V_{GS(th)}$	Gate Threshold Voltage	2.0	3.0	4.0	V	$V_{DS} = V_{GS}, I_D = 250\mu A$
$\Delta V_{GS(th)}/\Delta T_J$	Gate Threshold Voltage Coefficient	—	-8.4	—	mV/ $^\circ\text{C}$	
gfs	Forward Transconductance	113	—	—	S	$V_{DS} = 10V, I_D = 109A$
R_G	Gate Resistance	—	1.0	—	Ω	
I_{DSS}	Drain-to-Source Leakage Current	—	—	5	μA	$V_{DS} = 40V, V_{GS} = 0V$
		—	—	250		$V_{DS} = 40V, V_{GS} = 0V, T_J = 125^\circ\text{C}$
I_{GSS}	Gate-to-Source Forward Leakage	—	—	100	nA	$V_{GS} = 20V$
	Gate-to-Source Reverse Leakage	—	—	-100		$V_{GS} = -20V$

Dynamic Characteristics @ $T_J = 25^\circ\text{C}$ (unless otherwise stated)

	Parameter	Min.	Typ.	Max.	Units	Conditions		
Q_g	Total Gate Charge	—	129	194	nC	$V_{DS} = 20V, V_{GS} = 10V$ $I_D = 109A$ See Fig.11		
Q_{gs1}	Pre-Vth Gate-to-Source Charge	—	27	—				
Q_{gs2}	Post-Vth Gate-to-Source Charge	—	10	—				
Q_{gd}	Gate-to-Drain ("Miller") Charge	—	45	—				
Q_{godr}	Gate Charge Overdrive	—	47	—				
Q_{sw}	Switch Charge ($Q_{gs2} + Q_{gd}$)	—	55	—	nC	$V_{DS} = 16V, V_{GS} = 0V$		
Q_{oss}	Output Charge	—	54	—				
$t_{d(on)}$	Turn-On Delay Time	—	21	—			ns	$V_{DD} = 20V, V_{GS} = 10V$ ② $I_D = 109A$ $R_G = 1.8\Omega$
t_r	Rise Time	—	77	—				
$t_{d(off)}$	Turn-Off Delay Time	—	39	—				
t_f	Fall Time	—	38	—				
C_{iss}	Input Capacitance	—	7471	—			pF	$V_{GS} = 0V$ $V_{DS} = 25V$ $f = 1.0\text{MHz}$
C_{oss}	Output Capacitance	—	1640	—				
C_{rss}	Reverse Transfer Capacitance	—	737	—				
C_{oss}	Output Capacitance	—	5936	—				
C_{oss}	Output Capacitance	—	1465	—				
$C_{oss\ eff.}$	Effective Output Capacitance	—	2261	—				

Diode Characteristics @ $T_J = 25^\circ\text{C}$ (unless otherwise stated)

	Parameter	Min.	Typ.	Max.	Units	Conditions
I_S	Continuous Source Current (Body Diode)	—	—	184	A	MOSFET symbol showing the integral reverse p-n junction diode. 
I_{SM}	Pulsed Source Current (Body Diode) ③	—	—	736		
V_{SD}	Diode Forward Voltage	—	—	1.3	V	$I_S = 109A, V_{GS} = 0V$ ②
t_{rr}	Reverse Recovery Time	—	50	75	ns	$I_F = 109A, V_{DD} = 20V$
Q_{rr}	Reverse Recovery Charge	—	68	102	nC	$di/dt = 100A/\mu s$ ②

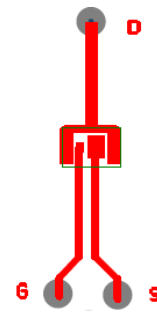
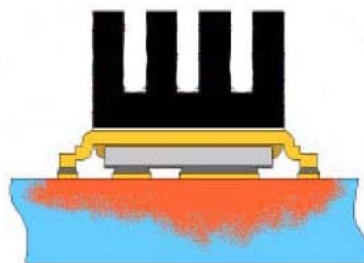
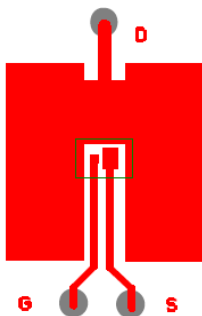

③ Surface mounted on 1 in. square Cu (still air).

② Mounted to a PCB with small clip heatsink (still air)

② Mounted on minimum footprint full size board with metalized back and with small clip heatsink (still air)

Notes ① through ⑩ are on page 9

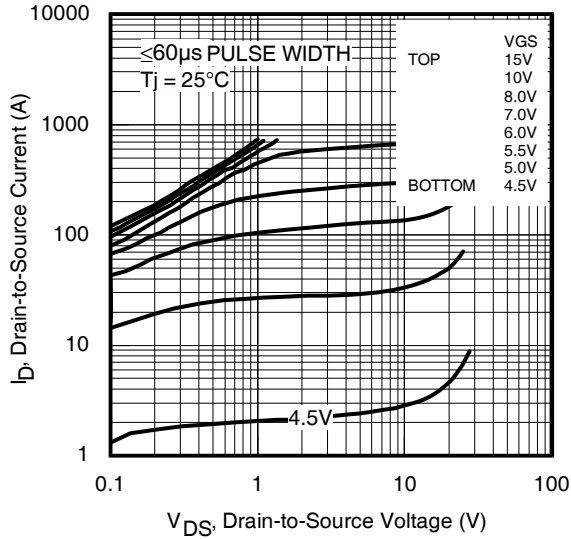

Fig 1. Typical Output Characteristics

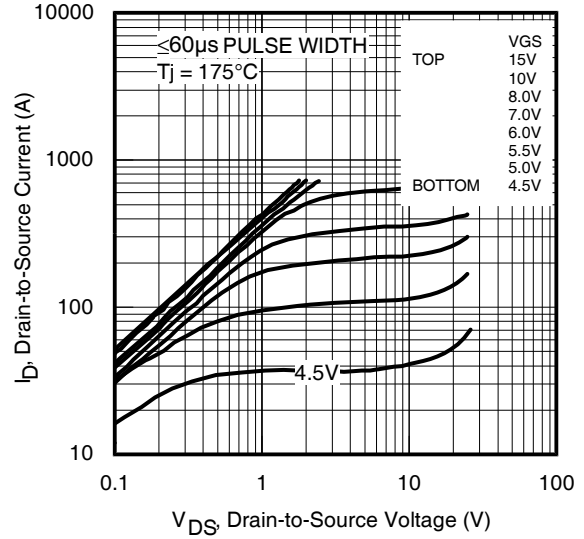

Fig 2. Typical Output Characteristics

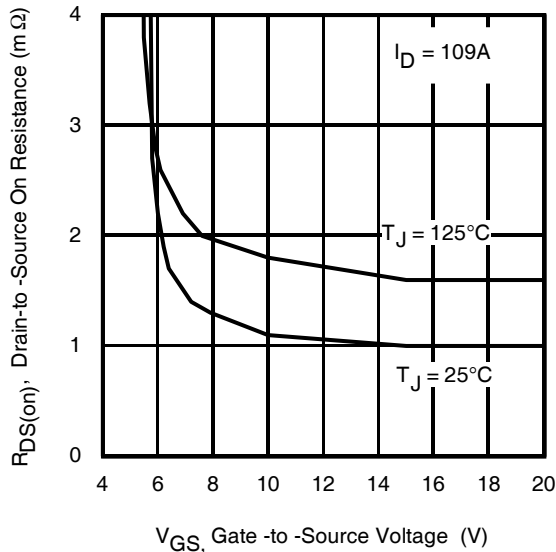

Fig 3. Typical On-Resistance vs. Gate Voltage

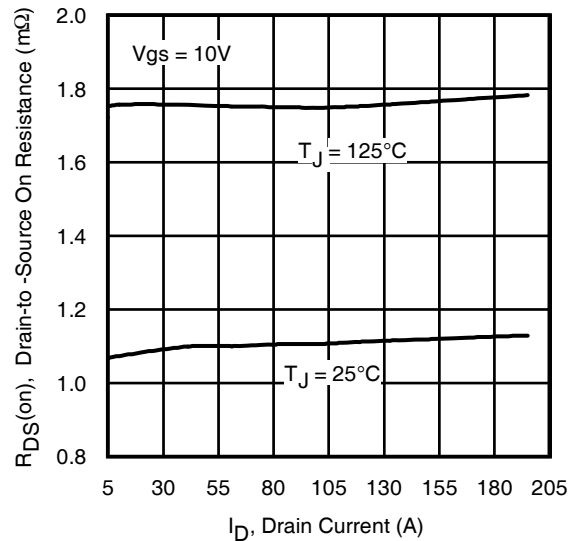

Fig 4. Typical On-Resistance vs. Drain Current

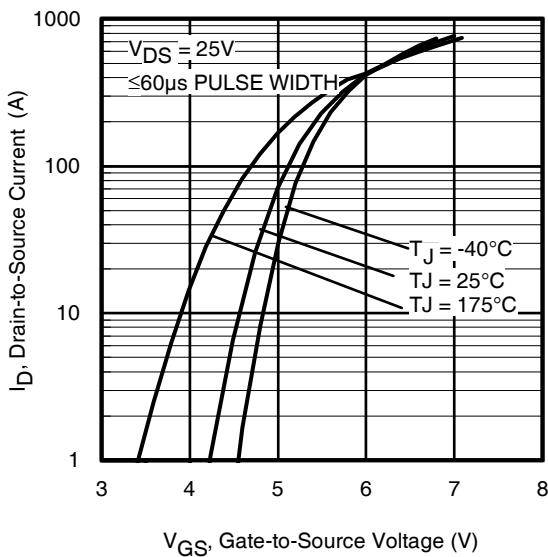

Fig 5. Typical Transfer Characteristics

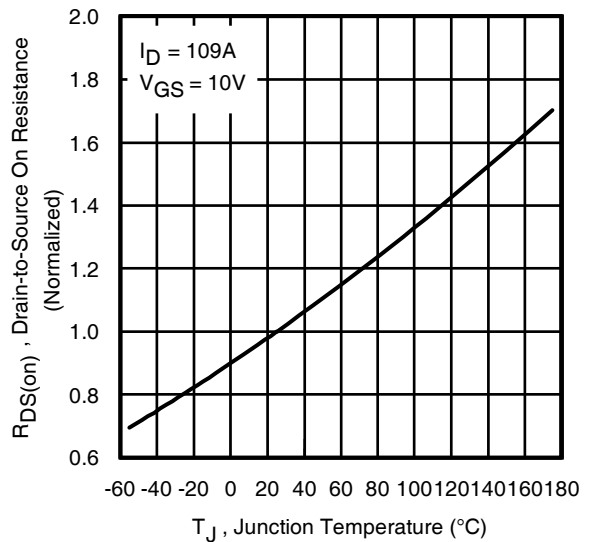

Fig 6. Normalized On-Resistance vs. Temperature

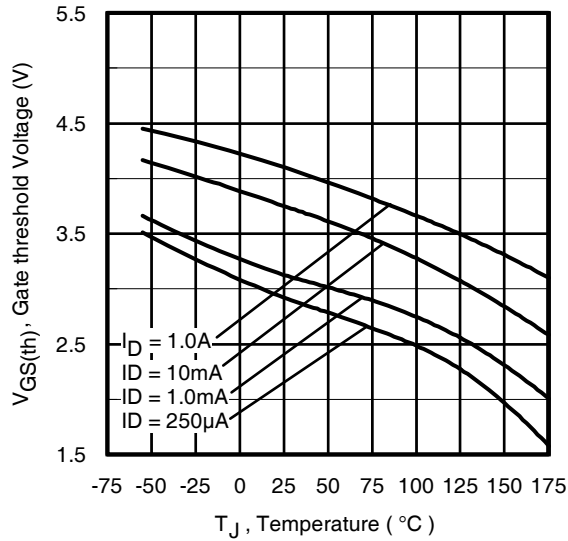

Fig 7. Typical Threshold Voltage vs. Junction Temperature

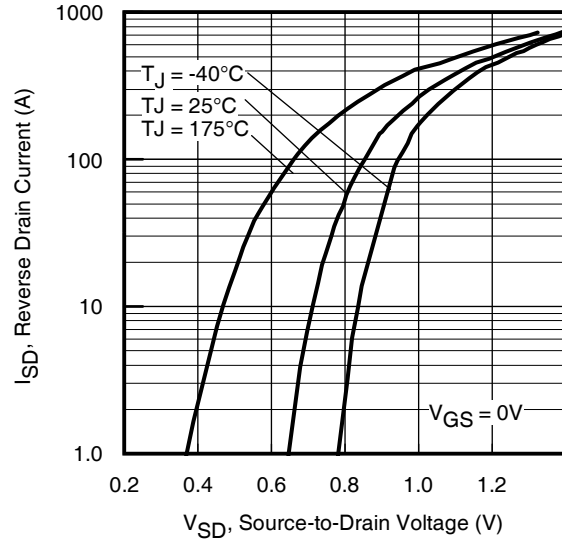

Fig 8. Typical Source-Drain Diode Forward Voltage

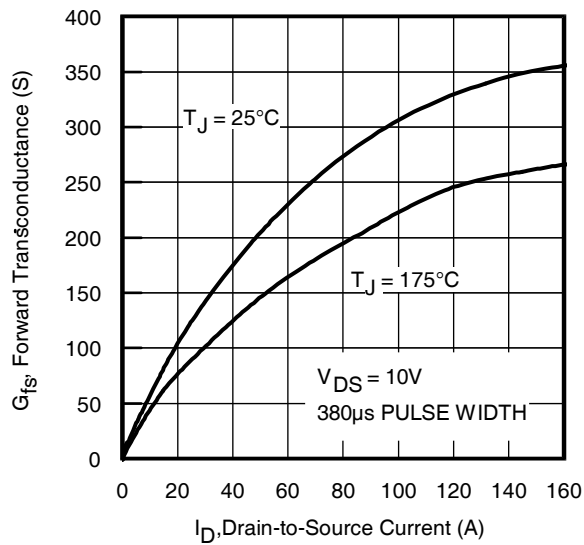

Fig 9. Typical Forward Transconductance Vs. Drain Current

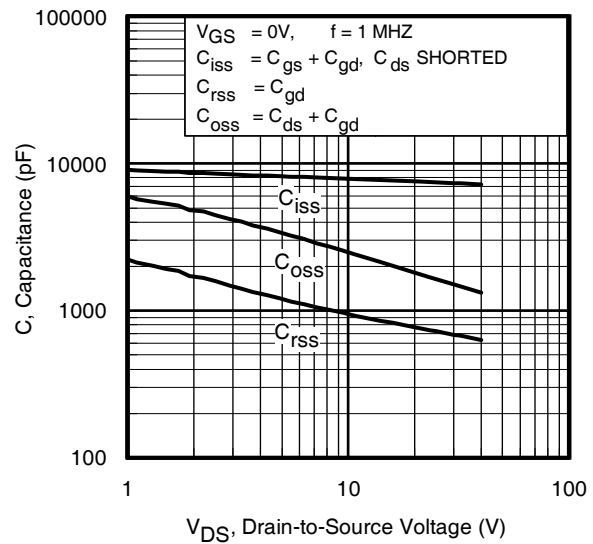

Fig 10. Typical Capacitance vs. Drain-to-Source Voltage

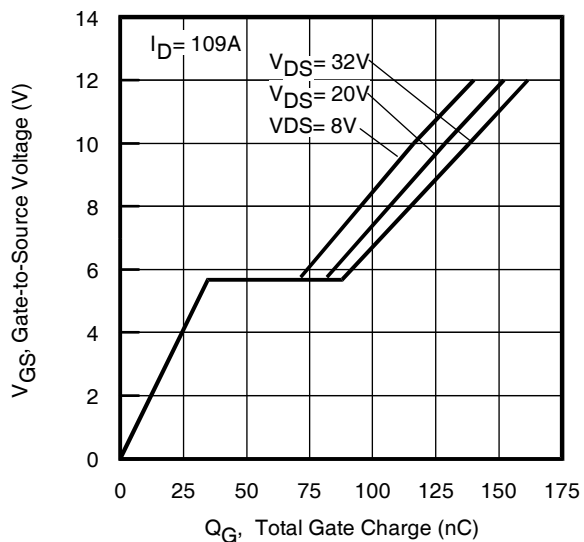

Fig.11 Typical Gate Charge vs. Gate-to-Source Voltage

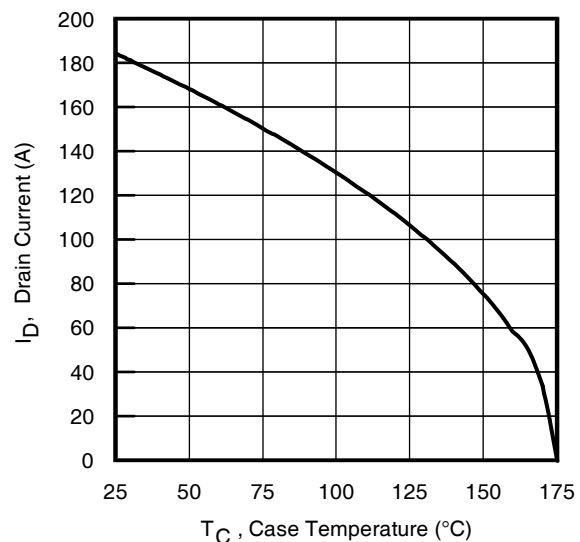

Fig 12. Maximum Drain Current vs. Case Temperature

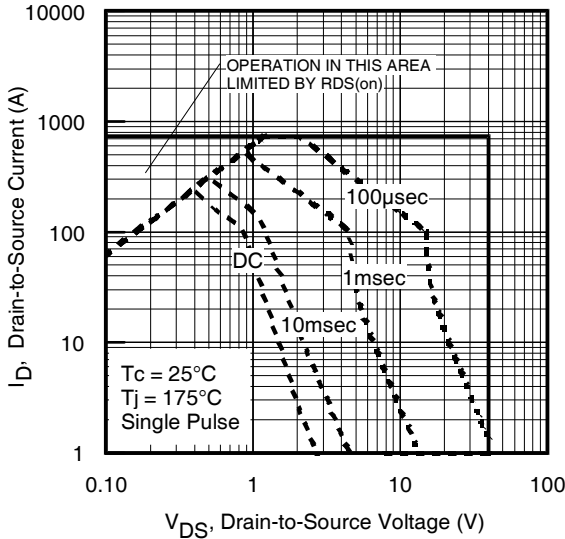

Fig 13. Maximum Safe Operating Area

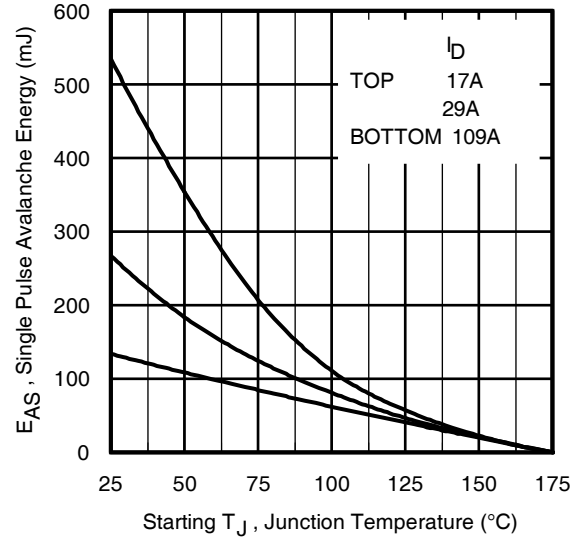

Fig 14. Maximum Avalanche Energy vs. Temperature

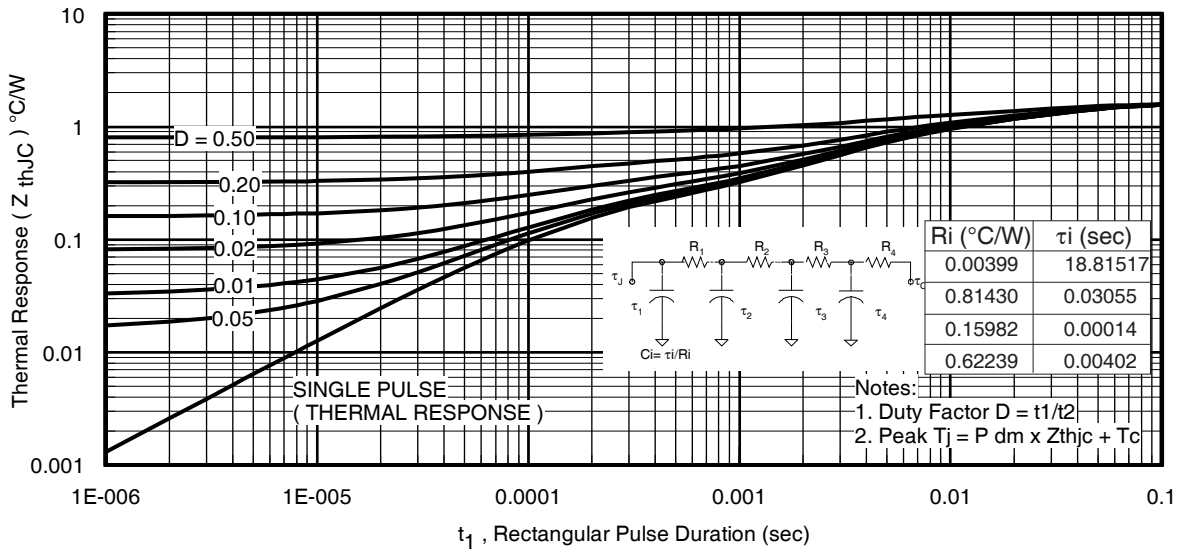

Fig 15. Maximum Effective Transient Thermal Impedance, Junction-to-Case

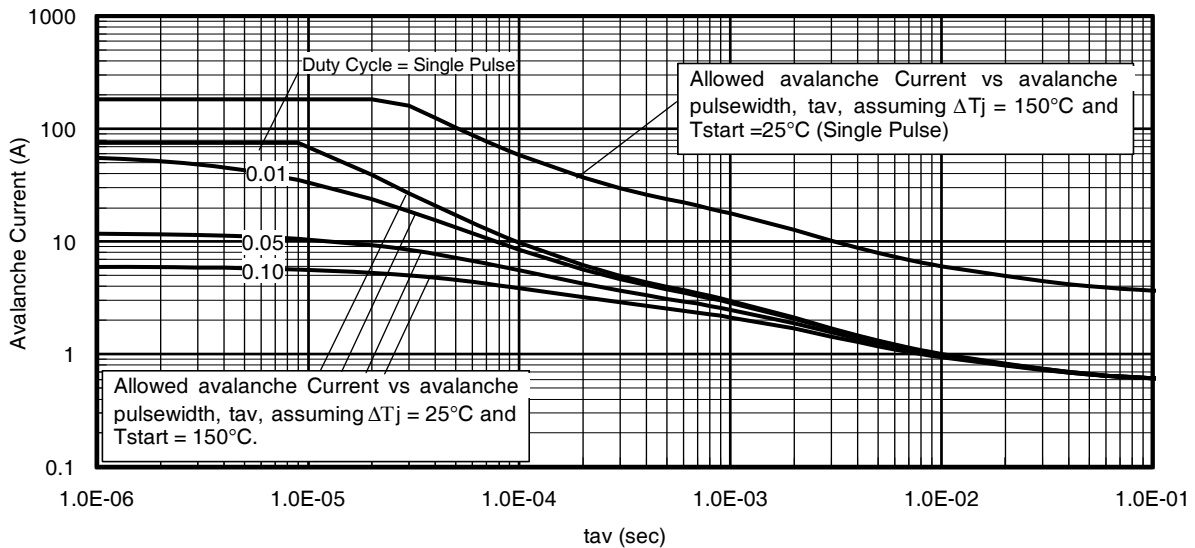

Fig 16. Typical Avalanche Current Vs. Pulsewidth

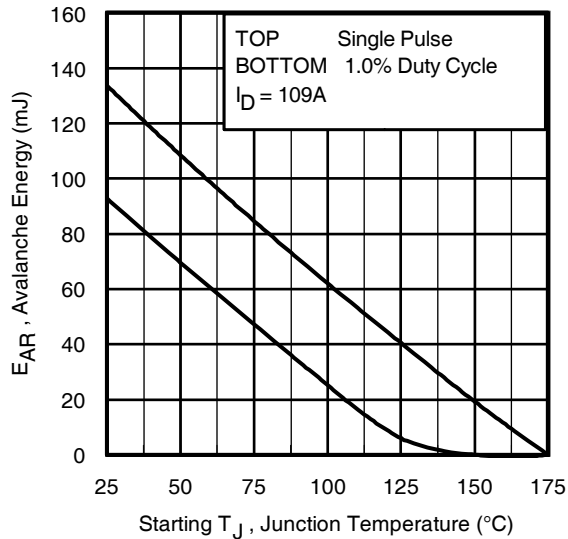

Fig 17. Maximum Avalanche Energy Vs. Temperature

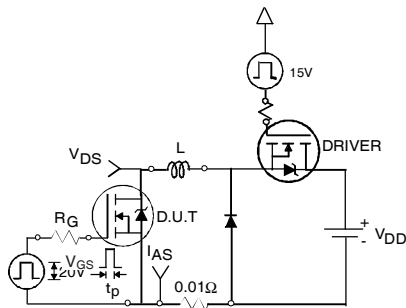

Fig 18a. Unclamped Inductive Test Circuit

$$P_{D(ave)} = 1/2 (1.3 \cdot BV \cdot I_{av}) = \Delta T / Z_{thJC}$$

$$I_{av} = 2\Delta T / [1.3 \cdot BV \cdot Z_{th}]$$

$$E_{AS(AR)} = P_{D(ave)} \cdot t_{av}$$

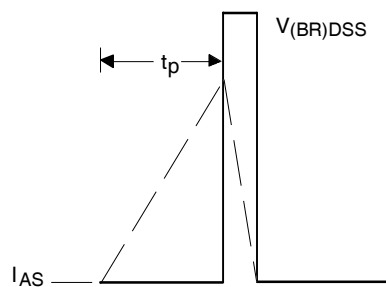

Fig 18b. Unclamped Inductive Waveforms

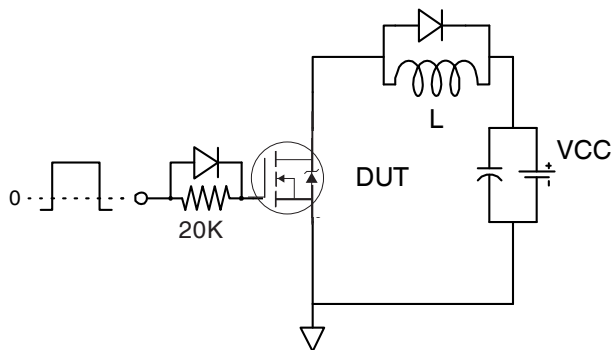

Fig 19a. Gate Charge Test Circuit

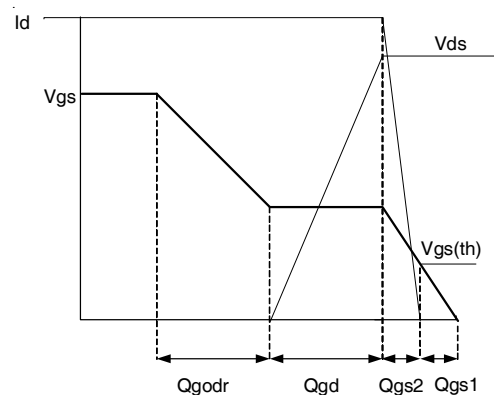

Fig 19b. Gate Charge Waveform

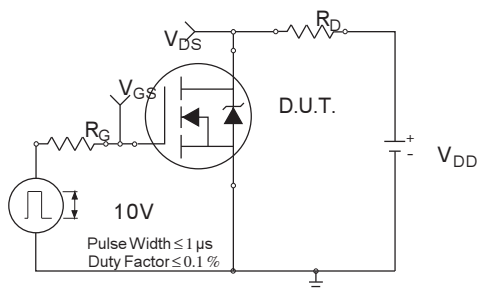

Fig 20a. Switching Time Test Circuit

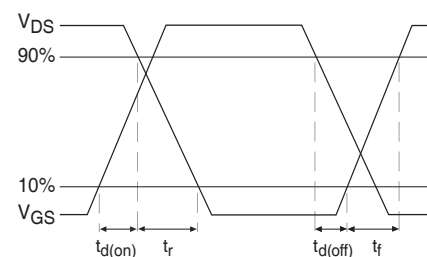

Fig 20b. Switching Time Waveforms

Notes on Repetitive Avalanche Curves , Figures 16, 17:
(For further info, see AN-1005 at www.irf.com)

1. Avalanche failures assumption:
Purely a thermal phenomenon and failure occurs at a temperature far in excess of T_{jmax} . This is validated for every part type.
2. Safe operation in Avalanche is allowed as long as T_{jmax} is not exceeded.
3. Equation below based on circuit and waveforms shown in Figures 18a, 18b.
4. $P_{D(ave)}$ = Average power dissipation per single avalanche pulse.
5. BV = Rated breakdown voltage (1.3 factor accounts for voltage increase during avalanche).
6. I_{av} = Allowable avalanche current.
7. ΔT = Allowable rise in junction temperature, not to exceed T_{jmax} (assumed as 25°C in Figure 16, 17).
 t_{av} = Average time in avalanche.
 D = Duty cycle in avalanche = $t_{av} \cdot f$
 $Z_{thJC}(D, t_{av})$ = Transient thermal resistance, see figure 15)

DirectFET® Board Footprint, L6 (Large Size Can).

Please see AN-1035 for DirectFET® assembly details and stencil and substrate design recommendations

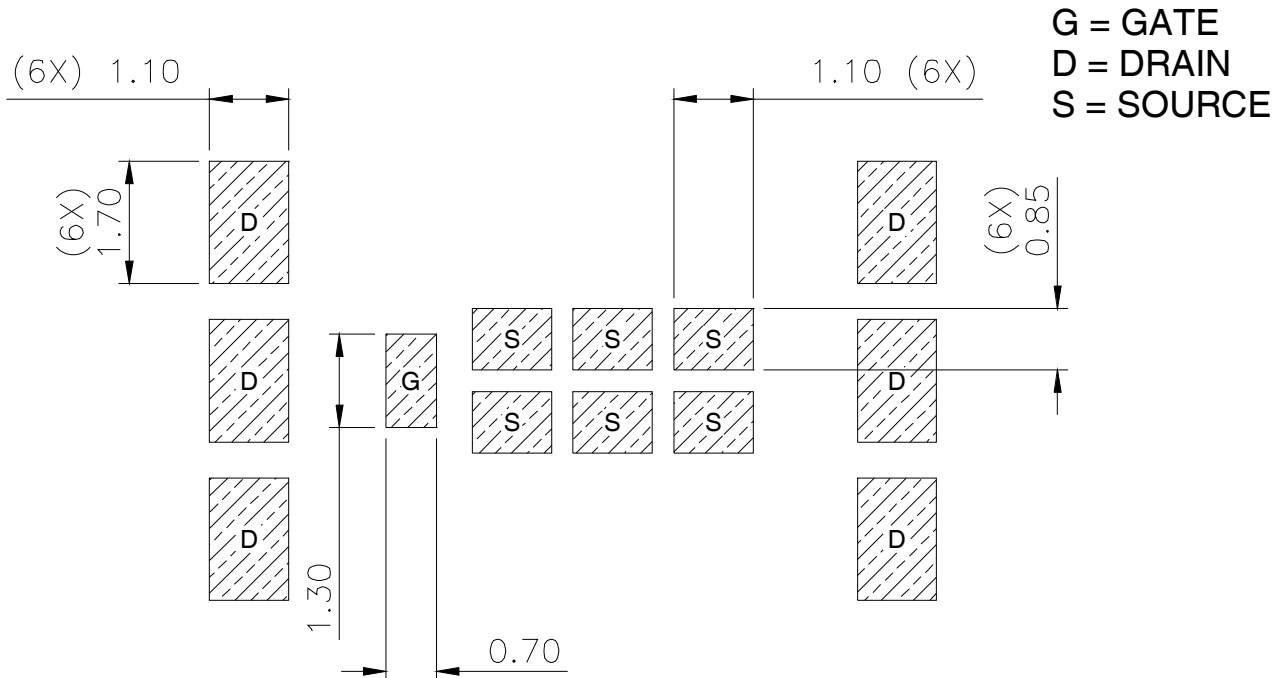
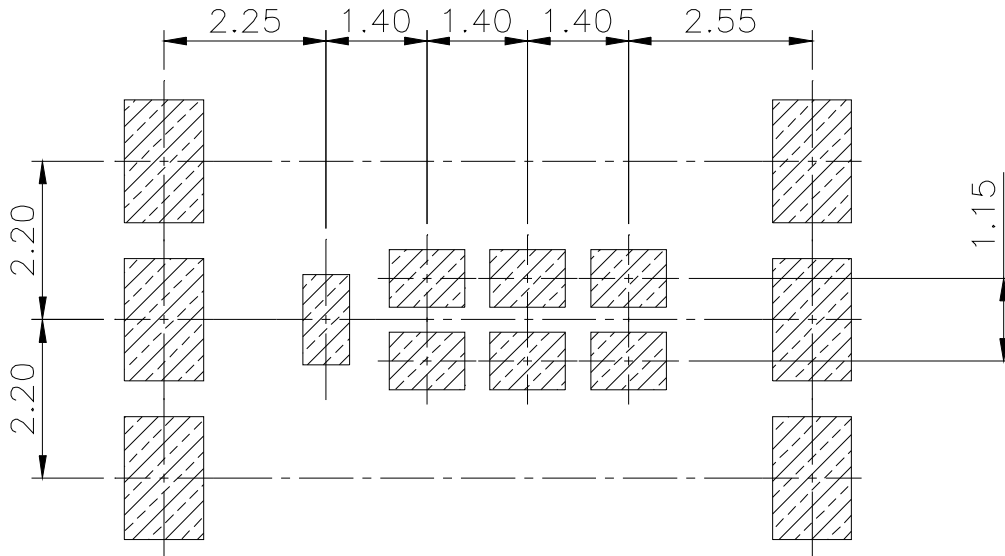

IRF7738L2TR/TR1PbF

DirectFET® Outline Dimension, L6 Outline (LargeSize Can).

Please see AN-1035 for DirectFET® assembly details and stencil and substrate design recommendations

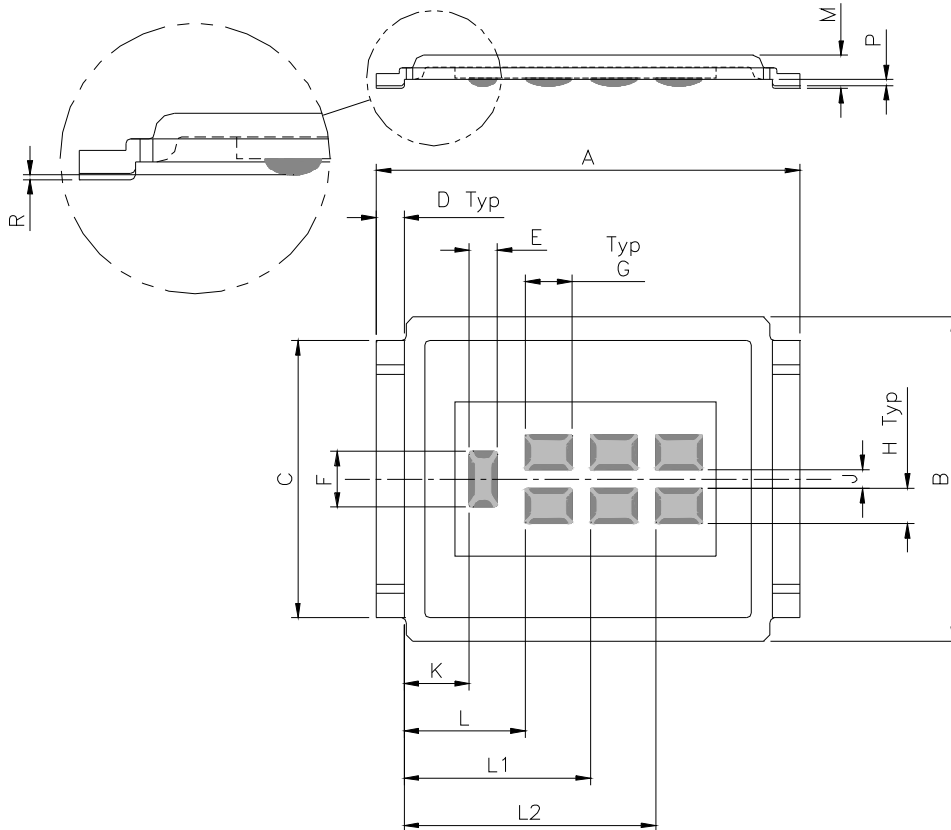

CODE	METRIC		IMPERIAL	
	MIN	MAX	MIN	MAX
A	9.05	9.15	0.356	0.360
B	6.85	7.10	0.270	0.280
C	5.90	6.00	0.232	0.236
D	0.55	0.65	0.022	0.026
E	0.58	0.62	0.023	0.024
F	1.18	1.22	0.046	0.048
G	0.98	1.02	0.039	0.040
H	0.73	0.77	0.029	0.030
J	0.38	0.42	0.015	0.017
K	1.35	1.45	0.053	0.057
L	2.55	2.65	0.100	0.104
L1	3.95	4.05	0.155	0.159
L2	5.35	5.45	0.210	0.214
M	0.68	0.74	0.027	0.029
P	0.09	0.17	0.003	0.007
R	0.02	0.08	0.001	0.003

DirectFET® Part Marking

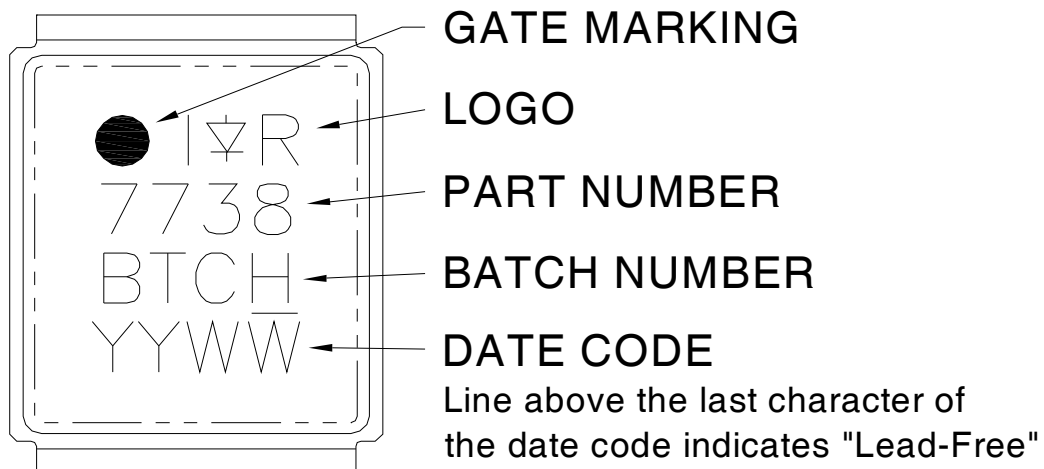

Note: For the most current drawing please refer to IR website at <http://www.irf.com/package/>

DirectFET® Tape & Reel Dimension (Showing component orientation).

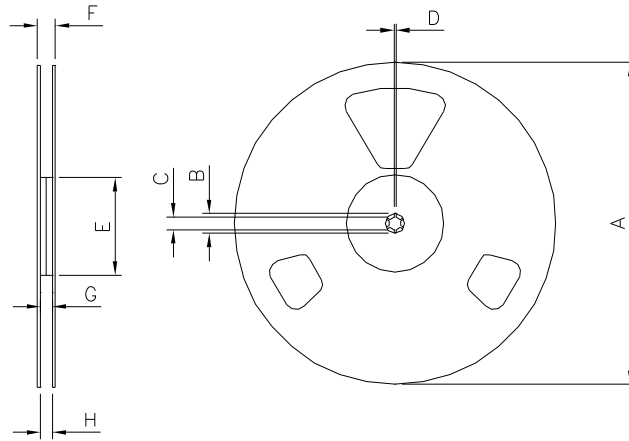

NOTE: Controlling dimensions in mm
 Std reel quantity is 4000 parts. (ordered as IRF7738L2TRPbF). For 1000 parts on 7" reel, order IRF7738L2TR1PbF

REEL DIMENSIONS								
CODE	STANDARD OPTION (QTY 4000)				TR1 OPTION (QTY 1000)			
	METRIC		IMPERIAL		METRIC		IMPERIAL	
A	330.00	N.C	12.992	N.C	177.80	N.C	7.000	N.C
B	20.20	N.C	0.795	N.C	20.20	N.C	0.795	N.C
C	12.80	13.20	0.504	0.520	12.98	13.50	0.331	0.50
D	1.50	N.C	0.059	N.C	1.50	2.50	0.059	N.C
E	99.00	100.00	3.900	3.940	62.48	N.C	2.460	N.C
F	N.C	22.40	N.C	0.880	N.C	N.C	N.C	0.53
G	16.40	18.40	0.650	0.720	N.C	N.C	N.C	N.C
H	15.90	19.40	0.630	0.760	16.00	N.C	0.630	N.C

LOADED TAPE FEED DIRECTION

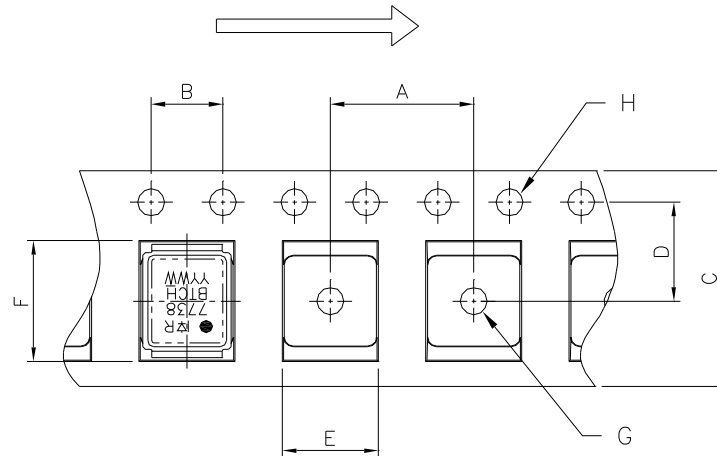

NOTE: CONTROLLING DIMENSIONS IN MM

CODE	METRIC		IMPERIAL	
	MIN	MAX	MIN	MAX
A	11.90	12.10	4.69	0.476
B	3.90	4.10	0.154	0.161
C	15.90	16.30	0.623	0.642
D	7.40	7.60	0.291	0.299
E	7.20	7.40	0.283	0.291
F	9.90	10.10	0.390	0.398
G	1.50	N.C	0.059	N.C
H	1.50	1.60	0.059	0.063

Part number	Package Type	Standard Pack		Note
		Form	Quantity	
IRF7738L2TRPbF	DirectFET2 Large Can	Tape and Reel	4000	"TR" suffix
IRF7738L2TR1PbF	DirectFET2 Large Can	Tape and Reel	1000	"TR1" suffix

Qualification Information[†]

Qualification level	Industrial ^{††}	
	(per JEDEC JESD47F ^{†††} guidelines)	
	Comments: This family of products has passed JEDEC's Industrial qualification. IR's Consumer qualification level is granted by extension of the higher Industrial level.	
Moisture Sensitivity Level	DFET2	MSL1 (per JEDEC J-STD-020D ^{†††})
RoHS Compliant	Yes	

[†] Qualification standards can be found at International Rectifier's web site

<http://www.irf.com/product-info/reliability>

^{††} Higher qualification ratings may be available should the user have such requirements. Please contact your International Rectifier sales representative for further information:

<http://www.irf.com/whoto-call/salesrep/>

^{†††} Applicable version of JEDEC standard at the time of product release.

Notes:

- ① Click on this section to link to the appropriate technical paper.
- ② Click on this section to link to the DirectFET® Website.
- ③ Surface mounted on 1 in. square Cu board, steady state.
- ④ T_C measured with thermocouple mounted to top (Drain) of part.
- ⑤ Repetitive rating; pulse width limited by max. junction temperature.
- ⑥ Starting T_J = 25°C, L = 0.022mH, R_G = 50Ω, I_{AS} = 109A.
- ⑦ Pulse width ≤ 400μs; duty cycle ≤ 2%.
- ⑧ Used double sided cooling, mounting pad with large heatsink.
- ⑨ Mounted on minimum footprint full size board with metalized back and with small clip heatsink.
- ⑩ R_θ is measured at T_J of approximately 90°C.